

# *FIREBERD<sup>®</sup> 6000*

## **REFERENCE MANUAL**

**JANUARY 1995**

**Rev. L**

**This Reference Manual applies to all FIREBERD 6000  
Communications Analyzers incorporating Software Revision L.**

**©1987 TELECOMMUNICATIONS TECHNIQUES CORPORATION®  
20400 Observation Drive, Germantown, Maryland 20876  
(800) 638-2049 or (301) 353-1550 (MD)  
FAX (301) 353-0731**

# TABLE OF CONTENTS

SECTION	PAGE
<b>1.0 GETTING STARTED</b> .....	<b>1-1</b>
1.1 DOCUMENT/SECTION SUMMARY .....	1-1
1.2 INSTRUMENT OVERVIEW .....	1-1
1.3 POWER REQUIREMENTS .....	1-2
1.4 GROUND JUMPER .....	1-3
1.5 WARNINGS .....	1-4
1.6 OPERATING CONVENTION .....	1-5
1.7 TEST CONFIGURATION .....	1-5
1.8 INSTRUMENT CHECKOUT .....	1-6
1.9 INTERFACE SELECTION .....	1-10
<b>2.0 INSTRUMENT DESCRIPTION</b> .....	<b>2-1</b>
2.1 SECTION SUMMARY .....	2-1
2.2 FUNCTIONAL DESCRIPTION .....	2-1
2.3 SPECIFICATIONS .....	2-2
2.4 FRONT PANEL SWITCHES AND INDICATORS .....	2-9
2.5 REAR PANEL .....	2-98
2.6 PERFORMING ERROR ANALYSIS .....	2-101
2.7 PERFORMING TIMING ANALYSIS .....	2-103
2.8 DELAY MEASUREMENTS .....	2-105
2.9 CONTENTION CONDITIONS .....	2-10
<b>3.0 PRINTER INTERFACES</b> .....	<b>3-1</b>
3.1 INTRODUCTION .....	3-1
3.2 PRINTOUT CONTROLS AND AUXILIARY FUNCTIONS .....	3-2
<b>4.0 REMOTE CONTROL</b> .....	<b>4-1</b>
4.1 INTRODUCTION .....	4-1
4.2 RS-232 REMOTE CONTROL OPERATION .....	4-1
4.3 IEEE-488 PRINTER/CONTROLLER INTERFACE .....	4-5
4.4 CONVENTIONS .....	4-10
4.5 UNIT CONTENTION .....	4-11
4.6 REMOTE CONTROL COMMANDS .....	4-12
4.7 STATUS REPORTING .....	4-90
4.8 ERROR MESSAGES .....	4-99
<b>5.0 OPTIONS AND ACCESSORIES</b> .....	<b>5-1</b>
5.1 SECTION SUMMARY .....	5-1
5.2 OPTIONS .....	5-1
5.3 ACCESSORIES .....	5-2
5.4 ORDERING INFORMATION .....	5-9

# TABLE OF CONTENTS (Continued)

APPENDICES	PAGE
APPENDIX A MAINTENANCE AND SERVICE .....	A-1
APPENDIX B JITTER OPTIONS .....	B-1
APPENDIX C CCITT G.821 PERFORMANCE ANALYSIS .....	C-1
APPENDIX D HEXADECIMAL CONVERSION TABLE .....	D-1
APPENDIX E SOFTWARE HISTORY .....	E-1
APPENDIX F FRAME RELAY .....	F-1
 INDEX .....	 I-1

## LIST OF FIGURES

1-1 The FIREBERD 6000 .....	1-2
1-2 Fuse/Voltage Selection Label .....	1-3
1-3 Component Side PC Board #40442 View of Upper Left Corner and Selectable .....	1-4
1-4 RS-232 Connector .....	1-11
1-5 Internal RS232 Menu .....	1-12
1-6 Installing an Optional Interface Module in a FIREBERD 6000 .....	1-15
2-1 FIREBERD 6000 Front Panel Switches and Indicators .....	2-11
2-2 Division of Test Seconds for Performance Analysis .....	2-22
2-3 PRINT EVENT Menu Tree .....	2-55
2-4 SYNTH FREQ Menu .....	2-59
2-5 INTF SETUP Menu .....	2-60
2-6 TEST INTERVAL Menu .....	2-61
2-7 CHAR FORMAT Menu .....	2-62
2-8 T1 JITTER Menu .....	2-63
2-9 PRINT EVENT Menu .....	2-64
2-10 STORE/RECALL/NAME Menu .....	2-66
2-11 AUXILIARY Menu .....	2-67
2-12 FIREBERD 6000 Rear Panel .....	2-99
3-1 Typical Controls Printout .....	3-3
3-2 Standard Results Print .....	3-4
3-3 Long Results Print .....	3-4
3-4 Custom Results Print .....	3-4
3-5 Delta Print .....	3-9
3-6 Status Prints .....	3-10
3-7 Automatic Histogram Printout, Graph Format .....	3-14
3-8 Manual Histogram Printout, List Format .....	3-14
3-9 Jitter Frequency List .....	3-16
3-10 Jitter Frequency Graph .....	3-17

## TABLE OF CONTENTS (Continued)

FIGURE	PAGE
4-1 FIREBERD 6000 Registers .....	4-90
4-2 Register Operation .....	4-91
4-3 Status Byte Register Group .....	4-92
4-4 Event Status Register Group .....	4-93
4-5 Line Summary Register Group .....	4-95
4-6 Interface Status Register .....	4-98
B-1 Jitter Menu Tree .....	B-3
B-2 Filter Bandwidths .....	B-7
B-3 Jitter Masks .....	B-11
B-4 G.703 Jitter Menu .....	B-13
B-5 2.048 Mb/s CCITT Jitter Masks .....	B-16
B-6 64 kb/s CCITT Jitter Masks .....	B-16
C-1 Division of Test Seconds for Performance Analysis .....	C-2
C-2 Sliding Window After 29th Test Second Still in Available Time .....	C-3
C-3 Sliding Window After 88th Test Second Still in Available Time .....	C-3
C-4 Sliding Window After 89th Test Second Transition to Unavailable Time .....	C-3
C-5 Sliding Window After 160th Test Second Transition to Available Time .....	C-4
F-1 Frame Relay Top Level Menus .....	F-3
F-2 Results On DLCI Menu .....	F-3
F-3 Frame Transmit Menu .....	F-4
F-4 Header Menu .....	F-5
F-5 Frame Load Menus .....	F-
F-6 PING Menu .....	F-7
F-7 Frame Length Menu .....	F-8
F-8 Link Management Menu .....	F-9
F-9 Frame Relay Frame Format .....	F-18

### LIST OF TABLES

1-1 Fuse Rating .....	1-3
1-2 RS-232-C Connector Pin Assignments .....	1-11
2-1 The MENU Keypad .....	2-57
2-2 Status-Select Auxiliary Functions .....	2-68
2-3 Non-Status Select Auxiliary Functions .....	2-71
3-1 RS-232 Printer/Controller Interface Connector Pin Assignments .....	3-2
4-1 RS-232 Pin Configuration .....	4-2
4-2 Standard Event Status Enable Register .....	4-30
4-3 Standard Event Status Register .....	4-31
4-4 Parallel Poll Enable Register .....	4-33
4-5 Service Request Enable Register .....	4-35
4-6 Status Byte Register .....	4-36

## TABLE OF CONTENTS (Continued)

TABLE	PAGE
4-7 Self Test Bit Response Value .....	4-37
4-8 Interface Status Register .....	4-81
4-9 Interface History Status Register .....	4-82
4-10 Interface History Enable Status Register .....	4-83
4-11 Interface Loss Status Register .....	4-84
4-12 Interface Loss Enable Status Register .....	4-85
4-13 Line Status Register .....	4-86
4-14 Line History Status Register .....	4-86
4-15 Line History Enable Status Register .....	4-87
4-16 Line Loss Status Register .....	4-88
4-17 Line Loss Enable Status Register .....	4-89
B-1 Frequency Point and Measurement Bandwidths .....	B-6
B-2 Filter Bandwidths .....	B-6
B-3 G.703 Wideband Jitter Measurement Specifications .....	B-14
B-4 G.703 Jitter Hits Measurement Specifications .....	B-14
B-5 G.703 Jitter Generator Amplitude Specifications .....	B-18
B-6 G.703 Jitter Generator Internal Generator Frequency Specifications .....	B-18
B-7 Frequency Points and Measurement Bandwidths .....	B-21
C-1 Performance Category Results .....	C-1
E-1 DDS Pattern Compatibility for Different Software Revisions .....	E-2



# FIREBERD 6000 REFERENCE MANUAL

## ADDENDUM



June 1999

50-14956-01 Rev. F

### INTRODUCTION

This addendum incorporates changes into the Revision L *FIREBERD 6000 Reference Manual*, 50-12120-01, for Revisions P, P.2, R, R.1, S, and T FIREBERD 6000 software. Revision P.2 provides inverse ARP capability to the FIREBERD 6000 Frame Relay Option. Revision R provides functionality for the 2M/34M ATM Data Interface Module (Model 31650). Revision R.1 includes Frame Relay capability for the High Speed Serial Interface Module (Model 42219A). Revision S includes BERT capability for the 34M Interface Module (Model 31812). Revision T includes support for the High Speed TTL Interface Module (Model 31910), unit now recognizes leap years, and updates T1.403 loop codes to 1995 specifications.

### FRONT MATTER

Make the following changes to the front matter of the reference manual.

*Change the Software Level to T in the upper right corner; change the date in the middle of the page to the date the changes are made to the manual; and change the revision level to Rev. T. Change the Software Revision level statement to "Software Revision T".*

### SECTION 2 INSTRUMENT DESCRIPTION

Make the following changes to Section 2, Instrument Description.

*Pages 2-68 through 2-71, Table 2-2 Status-Select Auxiliary Functions:*

*Add the following note to Receiver Action On Synchronization Loss (AUX 03) after the CONT paragraph:*

*This auxiliary function does not apply to results made available by the Frame Relay Option.*

*Add the following note to Single Transmit (AUX 04) after the disabled in self-loop mode paragraph:*

*When the Frame Relay Option is enabled, one frame will be transmitted each time **RESTART** is pressed.*

*Add the following note to Out-of-Band Flow Control (AUX 08), In-Band Flow Control (AUX 09), and Sync Loss Threshold (AUX 10): This auxiliary function is not available when Frame Relay is enabled.*

*Add the following note to Block Length (AUX 30): This auxiliary function is not applicable to Frame Relay operation.*

*Add the following note to Signal Delay (AUX 31): Start and stop parameters that reference patterns are not valid when Frame Relay is enabled.*

*Page 2-105 replace the first step of the Frequency Deviation Stress Test with the following: Set **GEN CLK** to **SYNTH**.*

**SECTION 4 REMOTE CONTROL**

Make the following changes to Section 4, Remote Control.

Page 4-6, please replace the IEEE-488 Interface DIP switch settings with the following: SW4:16, SW5:8, SW6:4, SW7:2 and SW8:1.

Page 4-74, please replace the RESULT:HOLD[ON|OFF] remote control command with the following: RESULT:HOLD. The on/off extensions are not required. The previous results in the buffer are overwritten by the current results whenever this command is invoked.

Page 4-95, Figure 4-5 Line Summary Register Group:

Replace Figure 4-5 with the following:

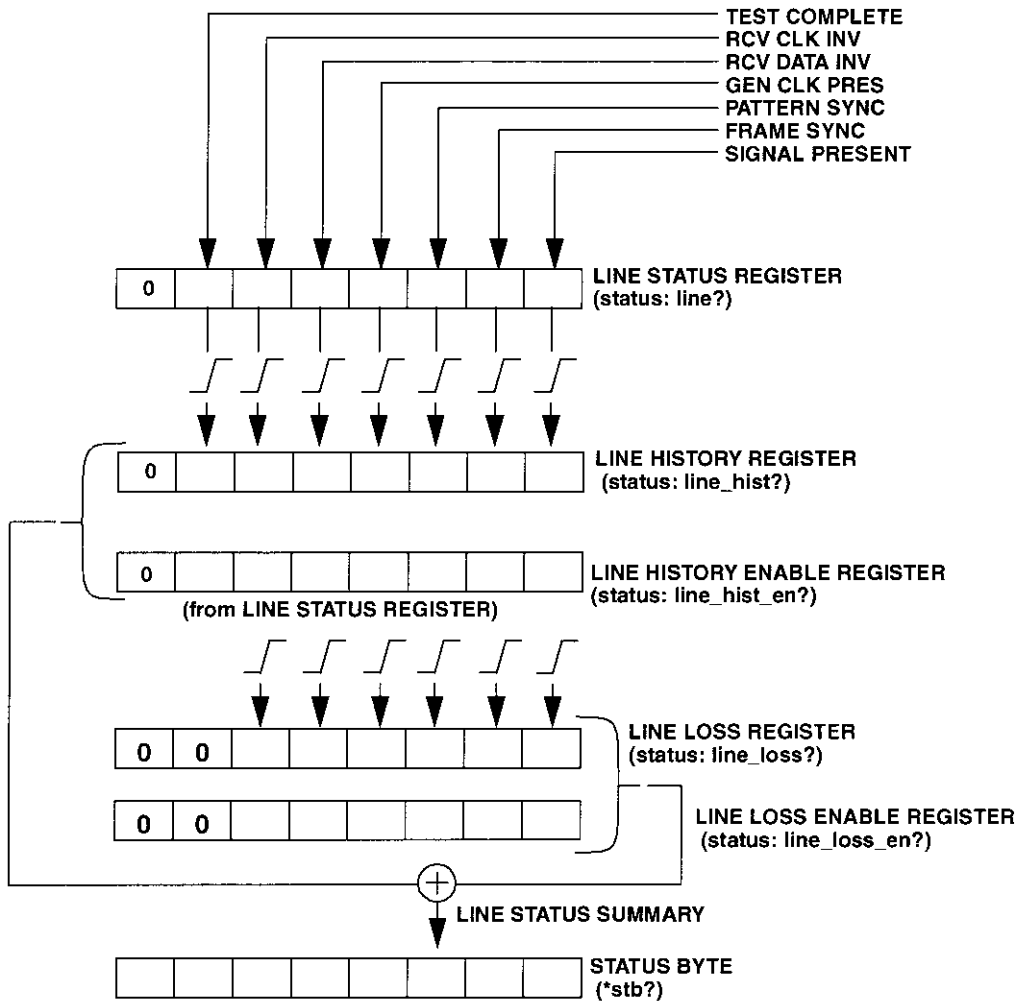

**Figure 1. Figure 4-5 Line Summary Register Group**

Page 4-96, The Line Loss Register Subsection:

Replace the definition of Bit 5 with the following: "Rx Overrun." This indicates the frame relay option receiver has overflowed since this register was last read.

Replace the definition of Bit 4 with the following: "Tx Underrun." This indicates the frame relay option receiver has underflowed since this register was last read.



**SECTION 5 OPTIONS AND ACCESSORIES**

---

Make the following change to Section 5, Options and Accessories:

*On page 5-11, replace the description of cable, Model 40601 with the following: Bantam plug (dual) to RJ48C (10').*

**APPENDIX F**

---

Replace entire Appendix F with the attached pages.

## APPENDIX F FRAME RELAY

### F.1. OVERVIEW

---

Frame relay is a packet-mode service with high throughput and low delay characteristics. Unlike other packet switching technologies, frame relay completely eliminates all processing at Layer 3 (Network Layer) of the OSI Reference Model and performs only a portion of the traditional Layer 2 (Data Link Layer). Since frame relay has no error correction capabilities, it must be implemented in relatively error-free networks to ensure high throughput.

The Frame Relay option is supported in FIREBERD 6000 equipped with Rev. K software and higher. The option allows you to perform Physical Layer analysis of the network by verifying the circuit is able to support frame relay operation.

The Frame Relay option provides the ability to collect basic protocol statistics about the frame relay circuit under test. These protocol statistics include:

- Frame Count
- Framed Octet Count
- Errored Frame Count
- Aborted Frame Count
- Frames with the FECN Bit Set
- Frames with the BECN Bit Set
- Frames with the DE Bit Set
- Average Utilization
- Maximum Utilization
- Average Throughput
- Maximum Throughput

These statistics can be collected on one specific DLCI or on the aggregate of all DLCIs.

With the Frame Relay option installed and the 12 FRAME RELAY Auxiliary Function enabled, the FIREBERD 6000 can turn up a frame relay link and then perform frame relay WAN protocol testing up to 2048 kb/s (higher rates with data communication interfaces).

The Frame Relay option provides ICMP (Internet Control Message Protocol) Ping capabilities, enabling in-service connectivity testing and round trip delay measurements. In addition, InARP (Inverse Address Resolution Protocol) functionality is added to the Ping capability. This enhancement allows the user to analyze the circuit and report the IP address of the device at the far end of the Permanent Virtual Circuit (PVC).

The Frame Relay option also allows the FIREBERD 6000 to generate frame relay loads with varying stress parameters. Frame relay parameters that can be varied include:

- Frame Size
- Throughput
- Transmission Pattern (Constant or Bursty)

The following interface modules are supported by the Frame Relay option.

Model:	Description:
INT232	Internal RS-232 Interface
40202	V.35/306 DTE/DCE Interface
40200	RS-449 (422/423) DTE/DCE Interface
42522	V.35/306/RS-449/X.21 DTE/DCE Interface
41400	RS-449/530/MIL Interface
30678/A	DDS DS0A/B Interface
41131/A/B	DDS Local Loop Interface
41440A	T1/FT1 Interface
40540	DS1/T1/D4/ESF/SLC-96 Interface
30608	CCITT G.703 64 kb/s Interface
30609	CCITT G.704 2048 kb/s Interface
41800	CCITT 2.048M/Nx64 kb/s Interface
40204	Lab (TTL) Interface
42219A	High Speed Serial Interface (HSSI) (requires software Rev. R.1 or higher)

To monitor a link, the selected interface must be connected as a DTE or DCE (DTE only with the 42219A interface) with the transmitter disabled (select RX only, not TX/RX, from the top level menu). The link being monitored can only be monitored in one direction (either DTE or DCE).

A special Y-cable (Part No. 43013-01) is required when using V.35 connections. This Y-cable disables the transmit functions during monitor mode and allows the user to select the direction in which frame relay traffic is to be monitored.

## F.2. INSTALLING THE FRAME RELAY OPTION

The Frame Relay option is a factory-installed option. Have the Frame Relay option installed in the FIREBERD 6000 at the time of purchase, or have the Frame Relay option installed as a factory retrofit. Retrofitting a FIREBERD 6000 requires one or more of the following assemblies to be replaced or upgraded:

- Data Generate & Receive board
- EPROM card (Rev. K or higher software)
- Processor board

## F.3. SELECTING THE FRAME RELAY OPTION

The following paragraphs describe the process for selecting the Frame Relay option and configuring the 12 FRAME RELAY auxiliary function to test frame relay circuits.

**F.3.1 Frame Relay Menu**

Press the **MENU** switch until the AUXILIARY LED illuminates. With the AUXILIARY FUNCTIONS menu displayed, press the LIST softkey to view the available auxiliary functions. Press the FWD (forward) softkey until the 12 FRAME RELAY auxiliary function appears. Then press the SELECT softkey to display the Frame Relay top level menu as shown in Figure F-1.

As an alternate way of enabling the Frame Relay option (once the AUXILIARY LED illuminates), press the 1 and 2 keypad keys and press **ENTER** to select Auxiliary Function 12.

**NOTE**

When the Frame Relay option is enabled, BER analysis, pattern selection, and LUP are disabled. However, you can still perform other measurements (e.g., CRC errors, BPVs, Signal level, etc.).

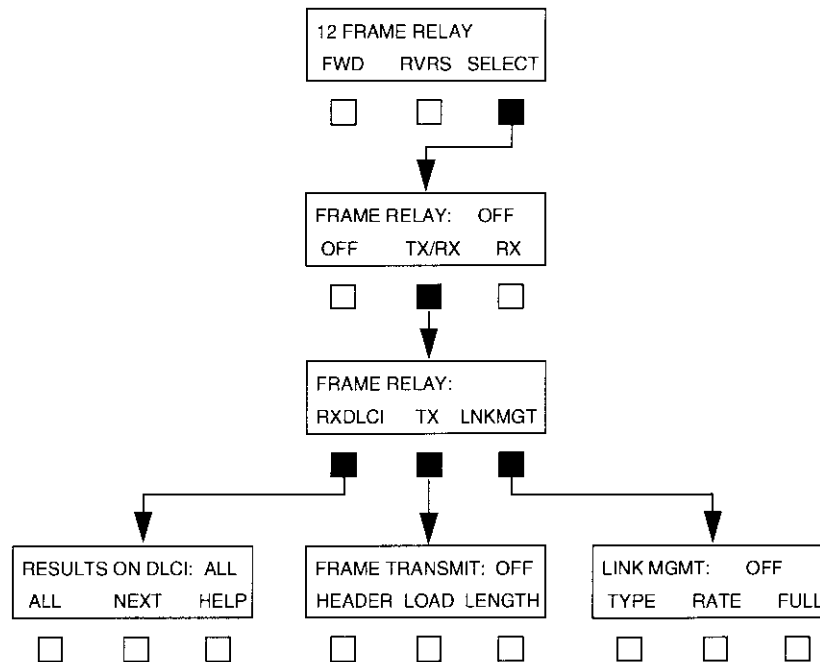

**Figure F-1. Frame Relay Top Level Menus**

Setting the 12 FRAME RELAY auxiliary function to ON backlights the AUX FUNC IN USE label and displays the following menu selections for frame relay testing:

- RXDLCI — Results On DLCI menu
- TX — Frame Transmit menu
- LNKMGMT — Link Management menu

**F.3.2 Results On DLCI Menu**

Pressing the RXDLCI softkey displays the Results On DLCI menu, as shown in Figure F-2. The Results On DLCI menu allows you to specify either all DLCIs, one specific DLCI (0 to 1023), or the next highest DLCI to be monitored.

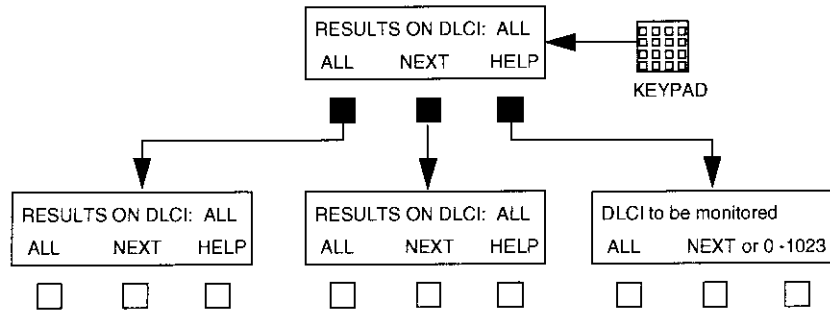

Figure F-2. Results On DLCI Menu

The Results On DLCI menu softkeys perform the following functions:

**ALL** — press the softkey to select all DLCIs to be monitored.

**NEXT** — the FIREBERD 6000 accumulates DLCIs from received frame headers and from the Full Status Link Management messages supplied by the network and stores them in a table. This softkey selects the next highest DLCI from that table to be monitored.

**HELP** — press the softkey to display the help information.

**Keypad (0 to 9)** — enter the specific DLCI (0 to 1023) to be monitored, then press ENTER. If you enter an invalid DLCI, the previously valid DLCI reappears.

**F.3.3 Frame Transmit Menu**

Pressing the TX softkey displays the Frame Transmit menu, as shown in Figure F-3. The Transmit Frame menu allows you to specify header data for the DLCI(s) being transmitted by the FIREBERD 6000 and the status of the bits in the address field. The Transmit Frame menu is controlled through the Frame Load menu.

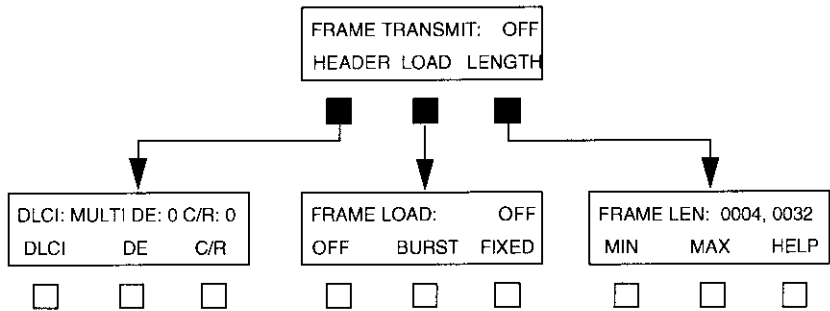

Figure F-3. Frame Transmit Menu

The Frame Transmit menu softkeys perform the following functions:

**HEADER Softkey**

Press the HEADER softkey to display the Header menu, as shown in Figure F-4. The Header menu selects the DLCI (single or multiple) being transmitted and sets the value of the DE, C/R, FECN, and BECN bits.

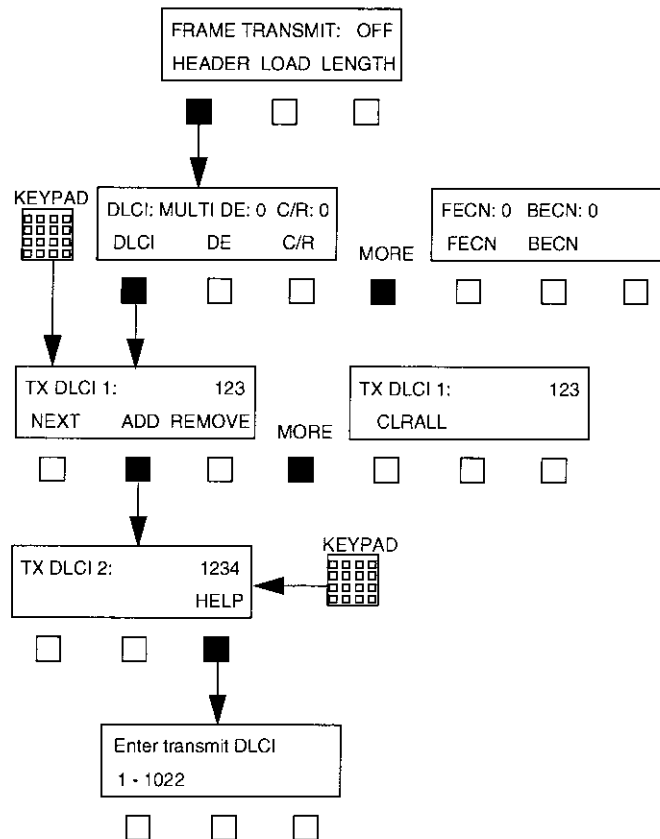

Figure F-4. Header Menu

The Header menu softkeys perform the following functions

**DLCI** — press the softkey to display the TX DLCI menu. This allows single or multiple DLCIs to be transmitted across multiple frames. The TX DLCI menu softkeys perform the following functions:

**NEXT** — press the softkey to scroll through and display multiple transmit DLCIs. The softkey is only functional when more than one transmit DLCI is programmed.

**ADD** — press the softkey to add a new transmit DLCI (TX DLCI xx:, xx = 1 to 10). Enter the DLCI number with the keypad.

**REMOVE** — press the softkey to delete the currently displayed transmit DLCI (TX DLCI xx:, xx = 1 to 10). TX DLCI 1 is the default TX DLCI and cannot be deleted.

**CLRALL** — press the softkey to clear all transmit DLCIs, except for TX DLCI 1. DLCI 1 defaults to DLCI number 25.

**HELP** — press the softkey to display the help information.

**Keypad (0 to 9)** — enter the specific DLCI (1 to 1023) to be transmitted to change the currently displayed transmit DLCI, then press ENTER. If you enter an invalid DLCI, the previously valid DLCI reappears.

**DE** — press the softkey to toggle the bit value to its opposite condition (0 or 1).

**C/R** — press the softkey to toggle the bit value to its opposite condition (0 or 1).

**FECN** — press the softkey to toggle the bit value to its opposite condition (0 or 1).

**BECN** — press the softkey to toggle the bit value to its opposite condition (0 or 1).

**LOAD Softkey**

Press the LOAD softkey to display the Frame Load menu, as shown in Figure F-5. The Frame Load menu allows you to specify the transmit channel loading type.

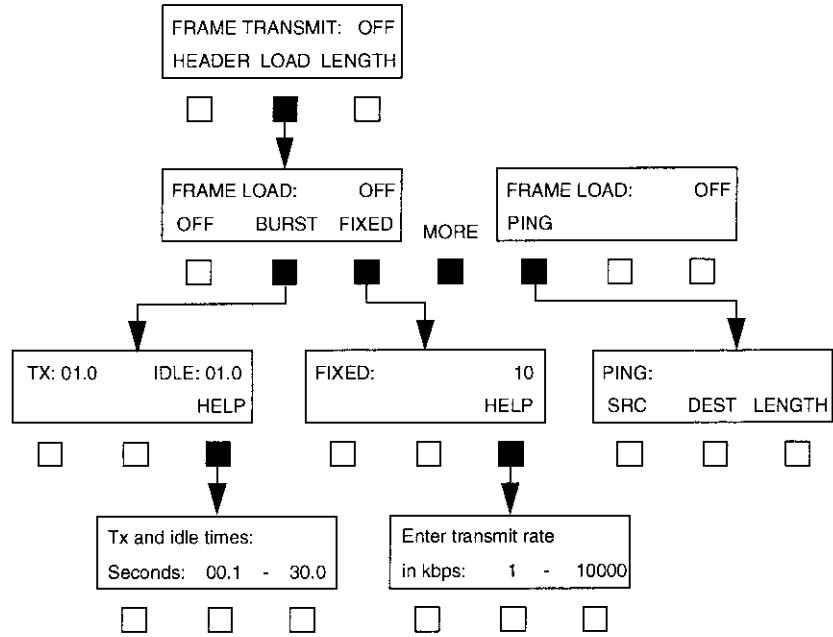

**Figure F-5. Frame Load Menus**

The Frame Load menu softkeys perform the following functions:

**NOTE**

For lost frame analysis, test DLCIs individually. Mainly because, the FIREBERD 6000 distributes the test frames equally across all configured transmit DLCIs. In addition, DLCIs often traverse the network over different physical paths causing transmitted frames to arrive out of sequence.

**OFF** — press the softkey to stop generating the frame load (except link management frames, if configured to do so).

**BURST** — allows you to specify the frame load burst transmit (TX) and idle (IDLE) times. Note that during the TX time, 100% utilization load is generated and 0% utilization is transmitted during the idle time. (Not functional with the 42219A interface).

**Keypad (0 to 9)** — enter the frame load burst transmit (TX) and idle (IDLE) times from 00.1 to 30.0 seconds, then press **ENTER**. If you enter an invalid time, the previously valid time reappears.

**HELP** — press the softkey to display the help information.

**FIXED** — allows you to specify a fixed information rate for transmission. The fixed rate is calculated over a 1-second interval (e.g., “10” transmits 10,000 frame bits per second over the line whether it is a T1 rate, 56k, etc.)

**NOTE**

Flags are considered overhead and are not included in the load they. They are in addition to the load rate.

**Keypad (0 to 9)** — enter the frame load transmission rate from 1 to 10,000 kb/s, then press ENTER. The actual maximum load is dependent on the frame length. If you enter an invalid rate, the previously valid rate reappears.

**HELP** — press the softkey to display the help information.

**PING** — allows you to specify source, destination, encapsulation method, and IP datagram length, as shown in Figure F-6. This function enables in-service connectivity testing and round trip delay measurements to be performed between IP configured frame relay routers and the FIREBERD 6000 or between FIREBERD 6000s. The FIREBERD 6000 can PING an IP router or another FIREBERD 6000. An IP router can also PING a FIREBERD 6000 (the FIREBERD 6000 supplies ICMP echo reply). Changing any ping parameter causes a test restart.

**NOTE**

**PING and InARP frames are sent only on the DLCI selected from the Results on DLCI Menu (RXDLCI softkey).**

The PING menu softkeys perform the following functions:

**SRC** — enter the IP source address of the ping-transmitting unit with the keypad (0 to 9), then press ENTER. The range for each address field is 000 to 255. If an invalid address is entered, the previous address reappears. This address is also used in response to received InARP requests.

**DEST** — enables automatic and manual selection of the IP destination address for the echo-reply unit. Manual selection is used when the IP address is known. When the IP source address is unknown, the InARP feature of Ping enables the user to generate and transmit a request to the far end device of any PVC and obtain its IP address. It also enables the far end device to request the FIREBERD’s IP address. The IP address recovered is used as the destination address for PING. When selected, the softkey MODE displays.

**MODE** — controls automatic IP addressing. The options are STAT and DYNM for static (manual) address selection and dynamic (automatic) InARP selection, respectively. When pressed, this softkey toggles between these modes. The active mode appears on the top line of the MENU display.

Static mode enables manual selection of the IP address. Using the keypad, select an IP address, ranging 000 to 255 for each address field. The echo-reply unit source address must match the ping-transmitting unit destination address. Press ENTER to implement the new address. If the address is outside the range or invalid, the previous address is restored.

Dynamic mode enables the transmission of InARP requests. To send an InARP request, press MODE until DYNM appears in the MENU display. Select the DLCI for transmission from the Results On DLCI Menu (RXDLCI softkey) as the *InARP request will be transmitted on the RXDLCI (transmit and receive DLCIs are linked for InARP functionality), see Figure F-2*. InARP requests are transmitted on one DLCI at a time and are not transmitted on DLCI 0 or 1023. If ALL is selected for the RXDLCI, the last configured receive DLCI is used. If a DLCI has not been configured, RXDLCI 25 is the default. Each time NEXT is pressed, a new InARP request is transmitted on the new DLCI. Once initiated, InARP requests are sent every five seconds until a



valid response is returned. The message **Sending InARP request** appears on the MENU display when the initial request is sent. The message **Waiting for InARP response** appears on the ANALYSIS RESULTS display until a response is returned. Received InARP requests will always result in the generation of a response.

In summary, InARP requests are transmitted when one of the following conditions exists.

- *NEXT is pressed; the DLCI is not 0, 1023 or ALL; and dynamic mode is enabled.*
- *The receive DLCI is entered using the keypad; the DLCI is not 0, 1023 or ALL; and dynamic mode is enabled.*
- *Dynamic mode is toggled to DYNM; and the DLCI is not 0, 1023 or ALL.*
- *An InARP response was not received within five seconds of the last transmitted request.*

**LENGTH** — enter the IP packet length with the keypad (0 to 9), then press ENTER. The packet length controls the ping frame length which is padded with the “Quick brown fox...” message. The range for ping frame length is 34 to 2000. If you enter an invalid length, the previously valid length reappears.

**ENCAP** — select one of the following encapsulation formats for PING and InARP frames:

**NONE** — disables encapsulation.

**NLPID** — enables Network Layer Protocol Identification encapsulation according to RFC 1490.

**ETHER** — enables Ethertype only encapsulation.

**HELP** — press the softkey to display the help information.

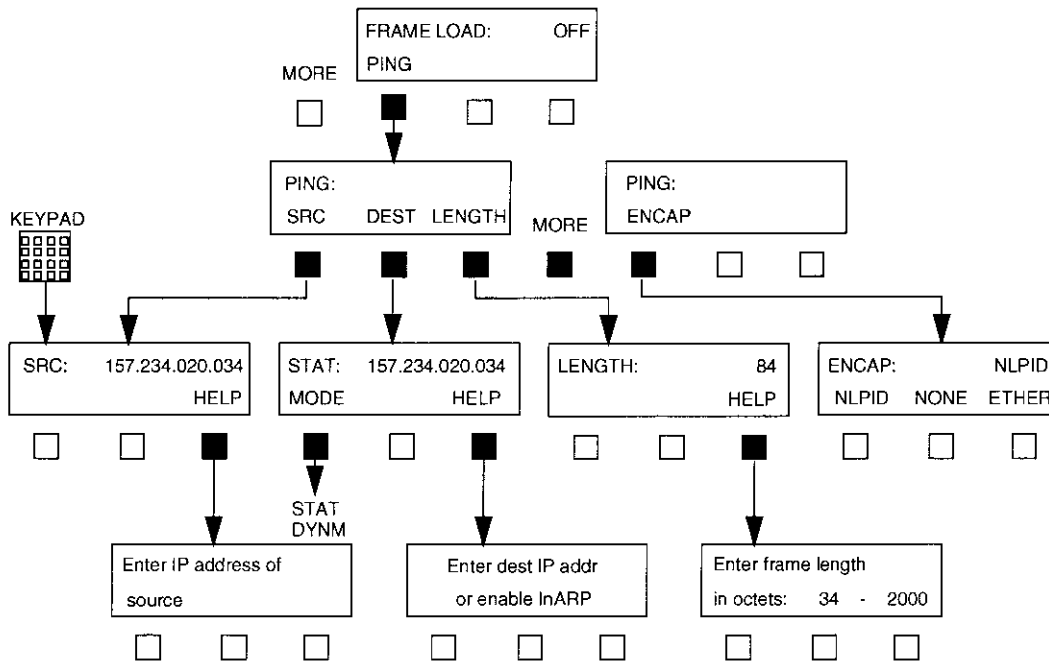

Figure F-6. PING Menu

**LENGTH Softkey**

Press the LENGTH softkey to display the Frame Length menu, as shown in Figure F-7. The Frame Length menu allows you to specify the minimum (4) and maximum (9999) frame length being transmitted. The frame length includes the header and the user data field but not the beginning and ending flags. This softkey is not applicable when LOAD is set to PING (there is a LENGTH softkey under PING).

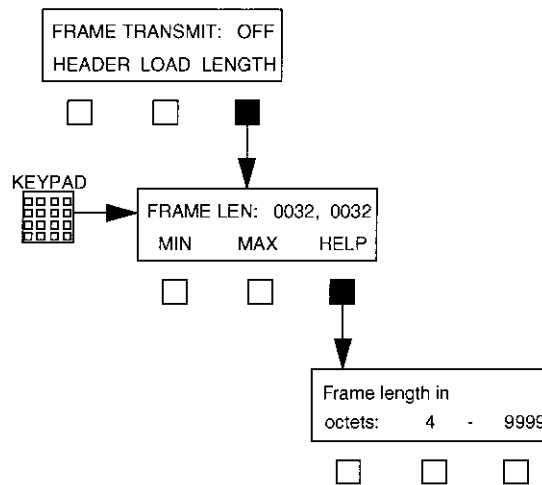

Figure F-7. Frame Length Menu

The Frame Length menu softkeys perform the following functions:

**MIN** — press the softkey to move the cursor under the most significant digit for the minimum frame length field (on the left). Enter the minimum information frame length (in octets from 4 to 9999) by using the keypad (0 to 9), then press **ENTER**. If you enter an invalid frame length, the previously valid frame length reappears.

**NOTE**

For lost frame analysis, the minimum frame length must be at least 16 bytes.

**MAX** — press the softkey to move the cursor under the most significant digit for the maximum frame length field (on the right). Enter the maximum information frame length (in octets from 4 to 9999) by using the keypad (0 to 9), then press **ENTER**. If you enter an invalid frame length, the previously valid frame length reappears.

**HELP** — press the softkey to display the help information.

**NOTE**

If you set the MIN value greater than the MAX value or set MAX to a value less than MIN, pressing **ENTER** automatically sets the MAX value equal to the MIN value setting. To transmit frames of equal length, set the MIN value equal to the MAX value.

**F.3.4 Link Management Menu**

Pressing the LNKMGMT softkey displays the Link Management menu, as shown in Figure F-8. The Link Management menu allows you to specify the link management type, poll status rate, duration, and interface.

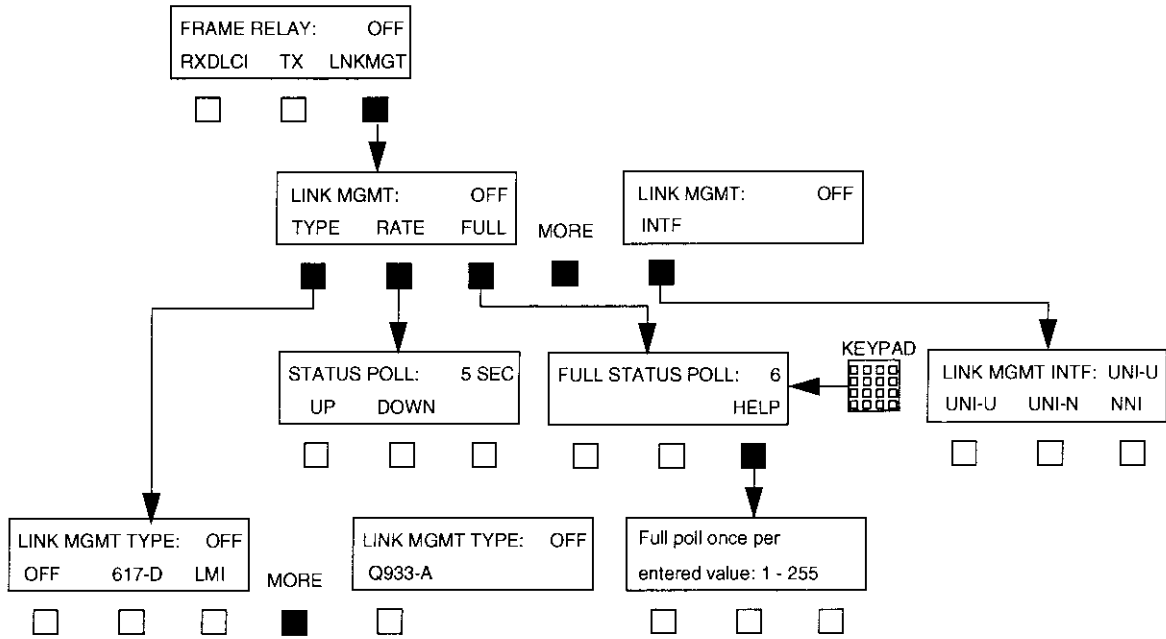

Figure F-8. Link Management Menu

The Link Management menu softkeys perform the following functions:

**TYPE** — press the softkey to display the Link Management Type menu. The Link Management Type menu allows you to select the type of link management to be used. The Link Management Type menu softkeys perform the following functions:

- OFF** — no link management is selected (Unsupported).
- 617-D** — selects the ANSI T1.617 Annex D link management.
- LMI** — selects the frame relay consortium local management interface.
- Q933-A** — selects ITU (CCITT) Q.933 Annex A link management.

**RATE** — press the softkey to display the Status Poll menu. The Status Poll menu displays the time interval between “STATUS ENQUIRY” polls transmitted by the FIREBERD 6000 to the network. The Status Poll menu softkeys perform the following functions:

- UP** — press the softkey to increment the status poll interval from 5 to 30 seconds in 5-second steps.
- DOWN** — press the softkey to decrement the status poll interval from 30 to 5 seconds in 5-second steps.

**FULL** — press the softkey to display the Full Status Poll menu. The displayed value indicates the interval between full status enquiry polls (measured in the number of status polls). Setting this menu to 5 and the Status Poll menu rate to 10, causes a full status poll to be transmitted every 50 seconds.

**Keypad (0 to 9)** — enter the full status enquiry poll interval from 1 to 255, then press **ENTER**. If you enter an invalid time, the previously valid time reappears.

**HELP** — press the softkey to display the help information.

**INTF** — press the softkey to display the Network Interface menu. The Network Interface menu allows you to select the direction in relation to the network. The Network Interface menu softkeys perform the following functions:

**UNI-U** — press the softkey to select the user (DTE) side of the user-network interface.

**UNI-N** — press the softkey to select the network (DCE) side of the user-network interface.

**NNI** — press the softkey to select bidirectional network-network interface.

### **F.3.5 Frame Relay Status Indicators and Messages**

The PATTERN SYNC LED indicates valid frame relay frames (on any DLCI) are being received. If no valid frames are received for 31 seconds then a synchronization loss is declared.

When the Frame Relay option is enabled, the BER analysis capability of the FIREBERD 6000 is not available. This means that pattern-related results (e.g., Bit Errors, BER, etc.) are not available when the Frame Relay option is active.

The messages Receiver Overrun Error and Transmitter Underrun Error occur when the Frame Relay system is receiving more frame relay traffic than can be processed, or is transmitting more traffic than can be processed, respectively. As a result, errored frames cannot be counted. To correct this, lower the rate at which the data is being transmitted to the FIREBERD 6000.

All other indicators and switches are based on the current interface selected.

## **F.4. AVAILABLE FRAME RELAY RESULTS**

---

The following ERROR and PERFORMANCE category results are provided when the Frame Relay option is enabled.

### **F.4.6 ERROR Category Results**

The following test results appear in the ERROR Category.

**TX PNG** — number of ping packets/frames transmitted by the FIREBERD 6000. The result only appears when the transmit frame load is set to PING.

**ECHO PNG** — number of successful echo replies transmitted by the FIREBERD 6000. The destination address within the arriving ping packet must match the source address of the unit transmitting the echo reply. The destination address of the unit transmitting an echo reply can be blank or incorrect, it is irrelevant. When the 12 FRAME RELAY auxiliary function is enabled, the result is incremented in any mode.

**LOST PNG** — number of ping packets that were not echoed back to the FIREBERD 6000; including out of order echo reply packets and corrupted echo reply packets. The result is not used in delay calculations. The result only appears when the transmit frame load is set to PING.

**FRM CNT** — a count of the total number of frame relay frames detected (including errored and aborted frames). This result can be calculated across all DLCIs or for one specific DLCI.

**FRM OCTS** — a count of the total number of octets received in valid frame relay frames. This result can be calculated across all DLCIs or for one specific DLCI.

**FRM RATE** — the average number of frames per second received since the start of the test.

**AVG FRM** — the average frame size calculated as the number of FRM OCTS divided by the FRM CNT number. This result can be calculated across all DLCIs or for one specific DLCI.

**FCS ERRS** — a count of the valid frame relay frames which have FCS errors. This result is calculated across all DLCIs. The number of errored frames incrementing indicates that there is a Physical Layer impairment on the monitored link.

**ABRT FRM** — a count of the aborted frame relay frames detected (excluding out of frame aborts). This result is calculated across all DLCIs. An aborted frame indicates the frame has become all 1s and that the link is dead or the switch on the other end stopped a frame in the middle of its transmission.

**SHRT FRM** — a count of the valid frames that are less than 4 bytes long, excluding flags. This result is calculated across all DLCIs. The incrementing of short frames indicates a network equipment fault.

**FECN FRM** — a count of valid frames with the Forward Explicit Congestion Notification (FECN) bit set (i.e., 1). This result can be calculated across all DLCIs or for one specific DLCI. This result incrementing indicates that the network is detecting congestion along the PVC at the receiving DLCI. Reducing the transmission frame relay rate is recommended.

**BECN FRM** — a count of valid frames with the Backward Explicit Congestion Notification (BECN) bit set (i.e., 1). This result can be calculated across all DLCIs or for one specific DLCI. When this result is incrementing, it indicates that frames transmitted on the PVC, for which BECN is set, are either causing or encountering congestion. Reducing the transmitted frame load should help to alleviate the condition.

**DE FRM** — a count of valid frames with the DE bit set (i.e., 1). This result can be calculated across all DLCIs or for one specific DLCI. When this result is incrementing, it indicates that received frames are being marked as “discard eligible”. This occurs because: 1) The far-end device is indicating that the frames can be discarded, or 2) The network is receiving frames from the far-end device at a rate that exceeds the committed information rate (CIR).

**LOST FRM** — a count of FIREBERD 6000 test frames that appear to have been lost by the network, based on gaps in the test frames sequence number. This result increments to indicate that frames are being dropped from the network. Frames are dropped by the network when the frame is errored (has an invalid FCS) or is discarded because of congestion or over-utilization. When generating frames on one DLCI, set the receive DLCI to the corresponding transmit DLCI to guarantee an accurate result. This result is not valid when the FIREBERD 6000 is transmitting on more than one DLCI.

**LMI MSGS** — the total number of LMI status or enquiry messages received since the start of the test if LMI INTF is UNI-U or UNI-N, respectively. An incrementing count for this result indicates a “heartbeat”.

**LMI ENQS** — the number of LMI status enquiry messages received if LMI INTF is NNI.

**LMI STAT** — the number of LMI status messages received if LMI INTF is NNI.

**LMI ERRS** — the total number of LMI errors detected. LMI errors indicate that the receive sequence number is not equal to the last transmitted send sequence number. This result incrementing indicates that the link management handshaking is not operating correctly.

**LMI TMOS** — the number of LMI timeouts. Indicates nonreceipt of a STATUS message within a polling interval after a STATUS ENQUIRY has been sent. This result incrementing indicates that the link from your FIREBERD 6000 to the network switch is down, that the link from the switch to you is down, or that the switch is down.

**NOTE**

The LMI results are only available when the Link Management Type is set to LMI, 617-D, or Q933-A.

**PVC STAT** — the current status of the selected DLCI. This result is only available when one specific DLCI is analyzed. This is the status that the switch is reporting. The PVC STAT result can have the following possible values.

Result Value:	Meaning:
“ “	DLCI is undefined
INACTIVE	DLCI is inactive
NEW	DLCI was just added
DELETED	DLCI was just deleted
RNR	DLCI status is RNR
ACTIVE	DLCI is active
NO STAT	DLCI is in use, but was not included in last status message

**F.4.7 PERFORMANCE Category Results**

The following test results appear in the PERFORMANCE Category:

**MIN PNG** — minimum round trip delay, in milliseconds, since the beginning of the test based on the time difference between a transmitted ping and a successfully received echo reply. Resolution is 100  $\mu$ s. The result only appears when the transmit frame load is set to PING.

**MAX PNG** — maximum round trip delay, in milliseconds, since the beginning of the test based on the time difference between a transmitted ping and a successfully received echo reply. Resolution is 100  $\mu$ s. The result only appears when the transmit frame load is set to PING.

**AVG PNG** — average round trip delay, in milliseconds, since the beginning of the test based on the time difference between a transmitted ping and a successfully received echo reply. Resolution is 100  $\mu$ s. The result only appears when the transmit frame load is set to PING.

**AVG%UTIL** — the average percentage of link utilization on the received channel since the start of the test calculated as the number of FRM OCTETS divided by the total number of octets received. This result can be calculated across all DLCIs or for one specific DLCI.

**MAX%UTIL** — the maximum percentage of link utilization on the received channel in any one second since the start of the test. This result can be calculated across all DLCIs or for one specific DLCI.

**AVG TPUT** — the average received throughput since the start of the test, calculated as total received User Data Field (UDF) bits divided by the total seconds. This result can be calculated across all DLCIs or for one specific DLCI. This result can be used to estimate the CIR.

**MAX TPUT** — the maximum received throughput during any one second since the start of the test. This result can be calculated across all DLCIs or for one specific DLCI.

**F.4.8    Error Print Results**

The FCS ERRS and ABRT FRM results are able to generate error prints.

**F.4.9    Delta Print Results**

The following results can appear in delta prints:

ABRT FRM  
AVG%UTIL  
BECN FRM  
DE FRM  
FCS ERRS  
FECN FRM  
FRM CNT  
FRM OCTS  
LOST FRM  
MAX%UTIL

**F.4.10    Results Prints**

When the Frame Relay option is selected, the standard results print additionally prints the following results:

ABRT FRM  
AVG TPUT  
AVG%UTIL  
FCS ERRS  
FRM CNT  
FRM OCTS  
LOST FRM

All results are displayed for long result prints.

**F.4.11    Histogram Results**

The following are results that can be selected to generate a histogram print:

ABRT FRM  
BECN FRM  
DE FRM  
FCS ERRS  
FECN FRM  
FRM CNT  
FRM OCTS  
LOST FRM

---

**F.5.    LINK LAYER ANALYSIS**

---

Link Layer analysis is performed in a monitoring or link terminating configuration. This allows statistics on the frame relay to be collected. The Link Layer analysis capability enables you to:

- Accumulate the following Link Layer statistics computed across the entire bandwidth, or for a single DLCI that you specify:

Total Frame Octets Received  
Total Frames Received  
Average Frame Size  
Frames with the FECN Bit Set  
Frames with the BECN Bit Set  
Frames with the DE Bit Set  
Errored Frames  
Aborted Frames  
Short Frames  
Average Throughput (kb/s)  
Maximum Throughput (kb/s)  
Average % Utilization  
Maximum % Utilization

## **F.6. LOAD GENERATION AND ANALYSIS**

---

When used in a link terminating configuration, the Frame Relay option can transmit FIREBERD 6000 test frames according to load parameters that you specify.

This ability to generate test frames meets or exceeds the following requirements.

- Generates fixed length frames with a total length of between 4 and 9999 octets; or
- Generates random length frames within a minimum and maximum length, which you specify (4 to 9999 octets) (flags are not included in the length specified).
- Generates frames at a fixed utilization between 1 and 10,000 kb/s, in 1 kb/s increments with the load distributed over the full link capacity (flags are not included in the length specified).; or
- Generates frames with a bursty utilization, at 100% utilization for 00.1 to 30.0 seconds, then at a 0% utilization (idle) for 00.1 to 30.0 seconds.
- Generates frames for one or multiple DLCIs (1 to 10), allowing you to control the state of the FECN, BECN, DE, and/or C/R bits.
- Generates frames of sufficient length to conform with RFC 1490, with the Network Layer Protocol Identifier (NLPID) and Subnetwork Access Protocol (SNAP) header ID set to identify the frame as a FIREBERD 6000 test frame. The user data in generated frames consists of a sequential count (from 0 to 65536), and the remainder of the data is a fixed pattern. Generated frames that do not have a length sufficient to conform with RFC 1490 will be a truncated form of the standard test frame. Note that the Frame Relay option supports AUX 04 (Single Transmit Mode).
- Received FIREBERD 6000 test frames have their sequence number analyzed for lost frames (LOST FRM), in addition to the standard Link Layer analysis described previously. Lost frame analysis is only valid in single TX/RX analysis mode.

## **F.7. LMI ANALYSIS AND EMULATION**

---

The Frame Relay option decodes Local Management Interface (LMI) messages to provide PVC and link status information in the form of LMI results. LMI messages are available whether in monitoring or terminating configurations.



In terminating configurations, LMI emulation can be configured for the user or the network side of the UNI, or for the NNI. The LMI analysis/emulation capability meets or exceeds the following requirements:

- Supports either ANSI T1.617 Annex D, the Frame Relay Forum scheme (optional extensions are not presently supported), or ITU Q.933 Annex A.
- Provides a user-selectable heartbeat polling (from 5 to 30 seconds), in 5-second increments.
- Provides a user-selectable full status polling interval (from 1 to 255 poll cycles).
- Provides the following LMI-derived results:

LMI MSGS  
LMI ERRS  
LMI TMOS  
PVC STAT  
LMI ENQS (NNI mode only)  
LMI STAT (NNI mode only)

## F.8. REMOTE CONTROL COMMANDS

Remote control commands used to control the Frame Relay option are described in the following paragraphs. The FIREBERD 6000 adheres to the IEEE-488.2 remote control syntax.

AUX:FRAME\_RELAY OFF

Turns off the Frame Relay option.

AUX:FRAME\_RELAY ON

Turns on the Frame Relay option.

AUX:FRAME\_RELAY TX\_RX

Places the Frame Relay option in Transmit/Receive (Emulation) mode.

AUX:FRAME\_RELAY RX

Places the Frame Relay option in Receive-Only (Monitor) mode.

AUX:FRAME\_RELAY?

Requests the status of the Frame Relay option.

AUX:FRAME\_RELAY:BURST\_TIME xxx

Sets the burst time in tenths of a second (where xxx = 001 to 300).

AUX:FRAME\_RELAY:BURST\_TIME?

Requests the current burst time selection.

AUX:FRAME\_RELAY:DLCI\_MON xxxxx

Selects the DLCI to be monitored (where xxxxx = All, NEXT, or 0 to 1023).

AUX:FRAME\_RELAY:DLCI\_MON?

Requests the DLCI being monitored.

AUX:FRAME\_RELAY:FIXED\_RATE xxxxx

Sets the fixed rate, in kb/s (where xxxxx = 1 to 10000).

AUX:FRAME\_RELAY:FIXED\_RATE?

Requests the fixed rate selection.

AUX:FRAME\_RELAY:HEADER:BECD [OFF | ON]

Sets the BECD bit (where OFF = 0 and ON = 1).

AUX:FRAME\_RELAY:HEADER:BECD?

Requests the BECD bit value.

AUX:FRAME\_RELAY:HEADER:CR [OFF | ON]

Sets the C/R bit (where OFF = 0 and ON = 1).

AUX:FRAME\_RELAY:HEADER:CR?

Requests the C/R bit value.

AUX:FRAME\_RELAY:HEADER:DE [OFF | ON]  
Sets the DE bit (where OFF = 0 and ON = 1).

AUX:FRAME\_RELAY:HEADER:DE?  
Requests the DE bit value.

AUX:FRAME\_RELAY:HEADER:DLCI nn, xxxx  
Sets the DLCI header (where nn = 1 to 10 and xxxx = 0 to 1023).

AUX:FRAME\_RELAY:HEADER:DLCI? nn  
Requests the DLCI header number.

AUX:FRAME\_RELAY:HEADER:DLCI\_ADD xxxx  
Adds a new transmitted DLCI (where xxxx = 0 to 1022).

AUX:FRAME\_RELAY:HEADER:DLCI\_num?  
Requests number of DLCI entries.

AUX:FRAME\_RELAY:HEADER:DLCI\_REMOVE nn  
Removes DLCI entry (where nn = 1 to 10).

AUX:FRAME\_RELAY:HEADER:FECN [OFF | ON]  
Sets the FECN bit (where OFF = 0 and ON = 1).

AUX:FRAME\_RELAY:HEADER:FECN?  
Requests the FECN bit value.

AUX:FRAME\_RELAY:IDLE\_TIME xxx  
Sets the idle time, in tenths of a second (where xxx = 001 to 300).

AUX:FRAME\_RELAY:IDLE\_TIME?  
Requests the current idle time selection.

AUX:FRAME\_RELAY:LNKMGT [OFF | 617-D | LMI | Q933-A]  
Sets the link management type (where OFF = none, 617-D = ANSI T1.617 Annex D, LMI = Frame Relay Forum, and Q933-A = Q.933 Recommendation).

AUX:FRAME\_RELAY:LNKMGT?  
Requests the frame relay link management type.

AUX:FRAME\_RELAY:LNKMGT:FULL xxx  
Sets the number of full LMI status polls that are sent (where xxx = 001 to 255).

AUX:FRAME\_RELAY:LNKMGT:FULL?  
Requests the number of full LMI status polls that are to be sent.

AUX:FRAME\_RELAY:LNKMGT:INTF [UNI-U | UNI-N | NNI]  
Sets the link management interface type (where UNI-U = User Network Interface - User Side, UNI-N = User Network Interface - Network Side, and NNI = Network-Network Interface).

AUX:FRAME\_RELAY:LNKMGT:INTF?  
Requests the link management user network interface type.

AUX:FRAME\_RELAY:LNKMGT:POLL xx  
Sets the frequency (how often) LMIs are sent, in seconds (where xx = 5 to 30, dividable by 5).

AUX:FRAME\_RELAY:LNKMGT:POLL?  
Requests the LMI poll interval time.

AUX:FRAME\_RELAY:MAX\_LENGTH xxxx  
Sets the maximum frame relay length (where xxxx = 4 to 9999).

AUX:FRAME\_RELAY:MAX\_LENGTH?  
Requests the maximum frame relay length selection.

AUX:FRAME\_RELAY:MIN\_LENGTH xxxx  
Sets the minimum frame relay length (where xxxx = 4 to 9999).

AUX:FRAME\_RELAY:MIN\_LENGTH?  
Requests the minimum frame relay length selection.

AUX:FRAME\_RELAY:TX\_LOAD [OFF | BURST | FIXED | PING]  
Sets the type of transmit load (where OFF = no transmission, BURST = transmission for the burst time, FIXED = the set rate (in kb/s) up to 10 Mb/s, and PING = enable PING function).

AUX:FRAME\_RELAY:TX\_LOAD?  
Requests the TX load selection.

AUX:FRAME\_RELAY:TX\_LOAD:PING\_DEST "xxx.xxx.xxx.xxx"  
Sets the IP destination address (where xxx = 000 to 255).

AUX:FRAME\_RELAY:TX\_LOAD:PING\_DEST?

Requests the IP destination address.

AUX:FRAME\_RELAY:TX\_LOAD:PING\_ADDR\_MODE [DYNM | STAT]

Sets the IP addressing mode (where DYNM = enables automatic IP addressing using InARP messages and STAT = enables manual selection of the IP address).

AUX:FRAME\_RELAY:TX\_LOAD:PING\_ADDR\_MODE?

Requests the IP addressing mode.

AUX:FRAME\_RELAY:TX\_LOAD:PING\_ENCAP [NONE | NLPID | ETHER]

Sets the encapsulation format (where NONE = off, NLPID = Network Layer Protocol Identification encapsulation enabled, and ETHER = Ethertype only encapsulation enabled).

AUX:FRAME\_RELAY:TX\_LOAD:PING\_ENCAP?

Requests the encapsulation format.

AUX:FRAME\_RELAY:TX\_LOAD:PING\_LENGTH nnnn

Sets the IP packet length (where nnnn = 34 to 2000).

AUX:FRAME\_RELAY:TX\_LOAD:PING\_LENGTH?

Requests the IP packet length.

AUX:FRAME\_RELAY:TX\_LOAD:PING\_SRC "xxx.xxx.xxx.xxx"

Sets the IP source address (where xxx = 000 to 255).

AUX:FRAME\_RELAY:TX\_LOAD:PING\_SRC?

Requests the IP source address.

### F.8.12 Results Commands

Below is a list the syntax for the results which can be used with the various FIREBERD 6000 Results commands/queries.

RESULT NAME	SYNTAX	RESULT NAME	SYNTAX
TX PNG	tx_ping	LOST PNG	lost_ping
ECHO PNG	echo_ping	MIN PNG	min_ping_rtd
MAX PNG	max_ping_rtd	AVG PNG	avg_ping_rdt
FRM CNT	frm_cnt	FRM OCTS	frm_octs
FRM RATE	frm_rate	AVG FRM	avg_frm
FCS ERRS	fcs_errs	ABRT FRM	abrt_frm
SHRT FRM	shrt_frm	FECN FRM	fecn_frm
BE CN FRM	becn_frm	DE FRM	de_frm
LOST FRM	lost_frm	LMI MSGS	lmi_msgs
LMI ENQA	lmi_enqs	LMI STAT	lmi_stat
LMI ERRS	lmi_errs	LMI TMOS	lmi_tmos
PVC STAT	pvc_stat	AVG%UTIL	avg%util
MAX%UTIL	max%util	AVG TPUT	avg_tput
MAX TPUT	max_tput		

## F.9. FRAME RELAY TECHNOLOGY

Frame relay is a protocol that is used to provide access to the public network. The FIREBERD 6000 tests the frame relay protocol at any User Network Interface (UNI) or Network-Network Interface (NNI) access points. In other words, frame relay is tested between user devices (i.e., routers, bridges, or host machines) and network equipment (i.e., switching nodes) and between any two pieces of network equipment. User devices are commonly referred to as DTE (Data Terminal Equipment), while network equipment that interfaces with the DTE is referred to as DCE (Data Circuit-terminating Equipment).

Frame relay is a streamlined protocol since it does not provide for error correction. It provides higher performance and greater efficiency, allowing greater throughput and bandwidth on demand. Frame relay accomplishes this by statistically multiplexing many logical data conversations (called virtual circuits) over a single physical transmission link. This statistical multiplexing provides a more flexible and efficient utilization of available bandwidth.

Due to recent improvements in digital transmission technology, wide area networks have produced transmission links with BERs (Bit Error Rates) of 1 in 100,000,000 bits. As a result of low BERs, Data Link Layer (Layer 2 of the ISO Reference Model) protocols can forego the link-by-link error correction algorithms, leaving this function to be performed by higher layers of protocol when necessary. This allows for greater performance and efficiency without sacrificing data integrity.

Frame relay was designed with this approach in mind. Frame relay provides a FCS (Frame Check Sequence) for the purpose of detecting corrupted data bits, but does not provide any means for correcting errors. Corrupted frames are simply discarded as they are encountered.

Due to the widespread use of higher layer protocols used to perform flow control, frame relay does not include explicit flow control procedures, since doing so would be redundant with those in higher layers. However, frame relay does provide a very simple congestion notification mechanism to allow a network to inform a user device (DTE) when the network has reached a congested state.

The frame relay frame is shown in Figure F-9 and is delimited by flags at the beginning (opening flag) and ending of the frame (closing flag). All frame relay frames start and end with the following 8-bit flag sequence: one 0 bit followed by six consecutive 1 bits and one 0 bit.

8	7	6	5	4	3	2	1
0	1	1	1	1	1	1	0
DLCI (high order bits)						C/R	EA
DLCI (low order bits)				FECN	BECN	DE	C/R
Information Field							
FCS							
FCS (cont'd)							
0	1	1	1	1	1	1	0

**Figure F-9. Frame Relay Frame Format**

The frame relay frame is transmitted from left to right and the octets are transmitted from top to bottom and is described as follows:

**DLCI** — Data Link Connection Identifier Address field (the MSB is Bit 8 in Octet 2 and the LSB is Bit 5 in Octet 3). The DLCI values available for use are determined by the service being provided.

**C/R** — Command/Response Indicator. The C/R bit, when implemented, is used (by the end user, not the network) to indicate whether the frame is a command or a response. Frame relay does not make use of this bit.

**FECN** — Forward Explicit Congestion Notification. The FECN bit is set by the network to notify the user that congestion avoidance procedures should be initiated, where applicable, for traffic in the direction of the frame carrying the FECN notification. The FECN bit is set to 1 in the direction of the

congestion to notify the user that the network is congested. This bit is set to 1 to indicate to the receiving end-system that the frames it is receiving have encountered congested resources.

**BECN** — Backward Explicit Congestion Notification. The BECN bit is set by the network to notify the user that congestion avoidance procedures should be initiated, where applicable, for traffic in the opposite direction of the frame carrying the BECN notification. The BECN bit is set to 1 in the opposite direction of the congestion to notify the user that the network is congested. This bit is set to 1 to indicate to the receiving end-system that the frames it is transmitting have encountered congested resources.

**EA** — Address Field Extension Bit Indicator. The EA bit is the first bit of each octet (byte) of the address field. When the EA bit is set to 0, it indicates that another octet is following in the address field. When the EA bit is set to 1, it indicates that it is the last octet and that no other octet is following in the address field. The FIREBERD 6000 only supports 2 octet addresses.

**DE** — Discard Eligibility. The DE bit is set to 1 to indicate that this frame is eligible to be discarded instead of other frames when congestion is encountered. The network may discard a frame that has the DE bit set to 1 if the frame is routed across a point where congestion is occurring. However, if at the point where congestion is occurring and all frames with the DE bit set to 1 have been dropped and congestion still exists, the network will begin dropping frames that have their DE bit set to 0. The DE bit is typically set by the network when the user traffic has exceeded their negotiated parameters.

**Information Field** — User data. The information field contains the data that the user is transmitting. The maximum length of this field is determined by the service provider.

**FCS** — Frame Check Sequence. The FCS field is used to determine whether the address field and information field contain any errors. Frames with an invalid FCS are discarded by the network. The FCS is considered to be invalid when the FCS calculated on the received frame does not match the FCS within the frame.

**Frame Abort** — A frame with 7 or more consecutive 1 bits is a frame abort sequence. Upon receipt of the frame abort sequence, the network discards the frame. All received data following the Abort Frame is discarded, up until the next valid flag is received.

---

## F.10. FRAME RELAY TESTING

---

You can use the Frame Relay option to:

- Perform complete physical layer testing of the local loop (or between nodes).
- Verify proper Link Management operation.
- Route frames across the network on a specific DLCI.
- Stress the network by transmitting frames (and monitoring at the receiving end).
- Non-intrusively monitor frame relay traffic on live data (excluding HSSI).
- Ping in-service routers and measure round trip delay.

Testing is considered to be intrusive (interrupting data) or non-intrusive (monitoring live data). Since intrusive testing is performed basically the same way as BER Physical Layer testing, only non-intrusive testing is discussed in the following paragraphs.

### F.10.13 In-Service Monitoring

You can perform non-intrusive monitoring of live data by using the V.35 "Y" cable and the RS449/V.35/306/X.21 interface (Model 42522) or the V.35/306 DTE/DCE interface (Model 40202).

#### NOTE

When performing tests with the V.35 "Y" cable (Part No. 43013-01), the maximum data rate recommended is 2 Mb/s.

When monitoring a T1 circuit, you can also use a bridging cable, a DSX MON jack, or any available monitor access point. The following steps describe the procedure for performing in-service monitoring.

1. With the FIREBERD 6000 power turned OFF, insert the T1/FT1 interface in the vacant interface slot on the rear panel.
2. Turn ON the FIREBERD 6000 power.
3. Press the **MENU** switch until INTF SETUP illuminates. First set the T1/FT1 CONFIG and MODE parameters.
4. Press the **MENU** switch until the AUXILIARY LED illuminates.
5. Press the 1 and 2 keys on the keypad, then press **ENTER** to display the 12 FRAME RELAY auxiliary function. Be sure ON appears. If not, press the softkey below ON to enable the Frame Relay option.
6. Configure the link management for the frame relay circuit being monitored by pressing the LNKMGMT softkey to display the selected link management. Be sure the displayed link management matches the link management for the frame relay circuit being monitored.
7. Adjust the link management interface to the opposite of what you are monitoring at the U interface. (i.e., select UNI-N when monitoring traffic from the DTE and select UNI-U when monitoring traffic from the switch).
8. As a precaution, verify that no frames are being transmitted by pressing the LOAD softkey. Be sure that OFF is displayed for the FRAME LOAD menu. If it is not, press the OFF softkey. (This is done since we are only monitoring data.)
9. Connect the bantam cable from the RX interface connector to the DSX MON jack to monitor data on the circuit you desire.
10. Press the **RESTART** key to clear any result values and begin monitoring live data.



Copyright 1996 TTC®

20400 Observation Drive, Germantown, Maryland 20876-4023 USA  
USA 1-800-638-2049 • +1-301-353-1550 (MD) • FAX +1-301-353-0234  
Canada 1-888-689-2165 • +1-905-507-4117 • FAX +1-905-507-4126

[www.ttc.com](http://www.ttc.com)

FIREBERD and TTC are registered trademarks of TTC. All other product names mentioned in this document are trademarks of their respective owners. Specifications, terms, and conditions are subject to change without notice.



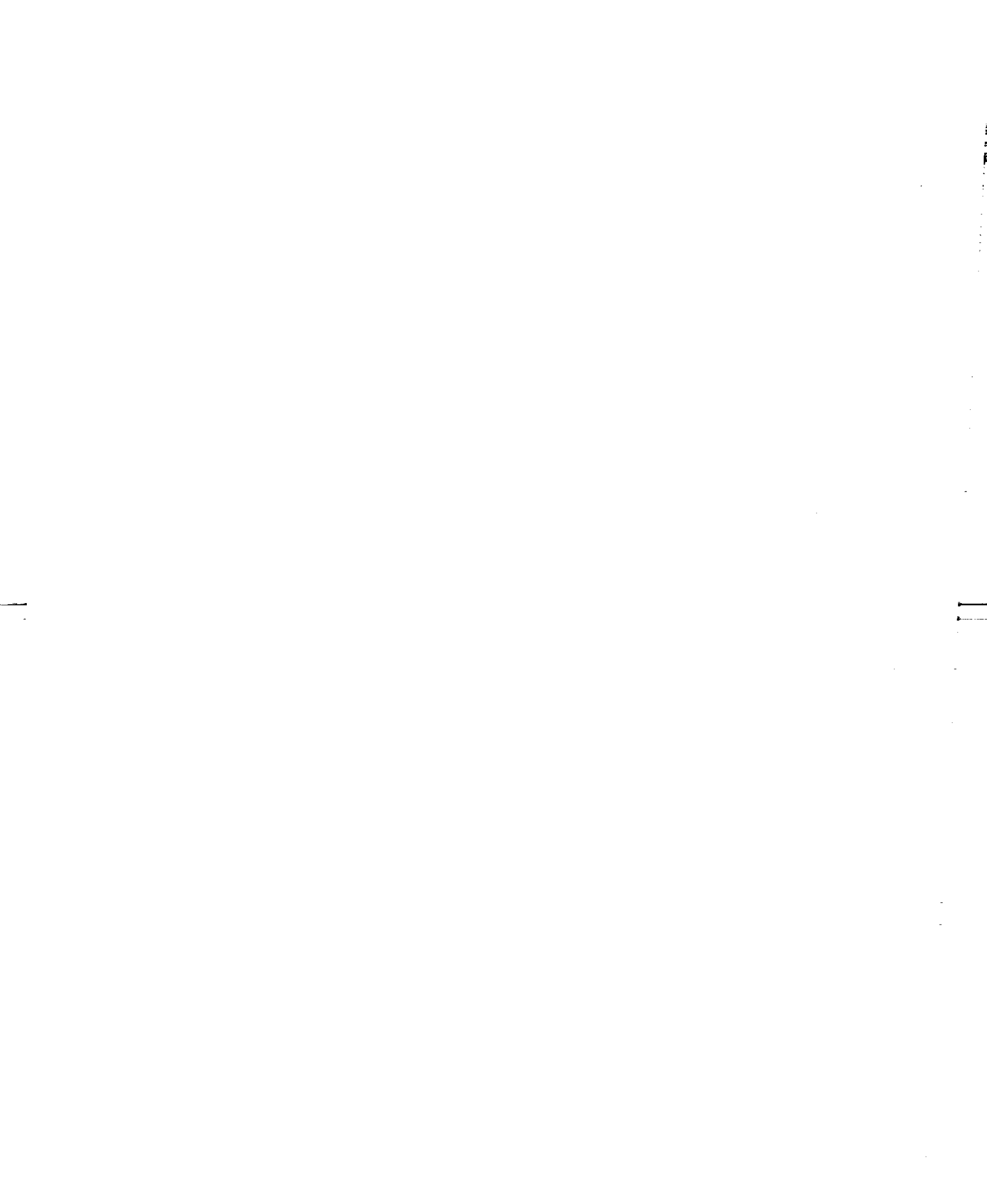



## SECTION 1 GETTING STARTED

### 1.1 DOCUMENT/SECTION SUMMARY

This manual offers detailed information about the Telecommunications Techniques Corporation (TTC) FIREBERD 6000 Communications Analyzer. It provides a complete instrument reference, including a general instrument description, operating instructions, and product specifications.

Please note that the information in this manual covers the plastic-case FIREBERD 6000, the metal-case FIREBERD MC6000, and the remote-control-only FIREBERD 6000R. Unless indicated otherwise, the name FIREBERD 6000 applies to all three mainframes.

Also note that the information in this manual applies to FIREBERD 6000 Communications Analyzers equipped with revision K software. Depending on the FIREBERD 6000 hardware configuration, all that may be required to install this latest software version in your FIREBERD is to remove and replace the EPROM card in the rear panel. The current software revision can be determined by pressing the **MENU** switch to illuminate the LED next to the AUXILIARY category. Then press the **4** and **0** keypad keys and press the **ENTER** key to display the software version installed in your FIREBERD. Call TTC Customer Service (1-800-638-2049) to find out about obtaining upgrades for your FIREBERD 6000.

Section 1 provides an overview of the FIREBERD 6000, power requirements, line power selection, ground jumper selection, operator warnings, operating convention, instrument checkout, internal RS232 Interface selection, and optional interface installation.

### 1.2 INSTRUMENT OVERVIEW

The FIREBERD 6000 (shown in Figure 1-1) is a multifunction communications analyzer that can terminate a variety of communications circuits and analyze the quality of the circuit under test. A rear panel interface slot provides the flexibility to access the circuit at a variety of locations. Locations in which the FIREBERD can be used include: central offices (COs), technical control centers, end-user sites, engineering laboratories, and earth stations. The location where access to the circuit can be gained determines the interface that is installed in the FIREBERD 6000. The interface provides the physical connection to the circuit under test. The interface also provides proper termination, signal conditioning, framing (if required), and timing. See Section 5 for a list of interfaces available for use with the FIREBERD 6000. These interfaces can be divided into the following categories:

- DDS Interfaces (DDSSL, DS0A/B, and DS0/A)
- T-Carrier Interfaces (T1/FT1, DS1/T1, T1C/2, and T3)
- CCITT Interfaces ( 64K/G.703, 2M/m64, 2M/G.704, and 8M/G.703)
- Data Interfaces (RS-232-C, RS-449, V.35, MIL449, 449/V35, and HSSI)
- Specialty Interfaces (ISDN, LAB, Dipphase, and Access)

An optional interface is inserted in the FIREBERD interface slot and then either controlled locally or remotely. This allows the user to operate the FIREBERD locally by using the front panel switches and controls, or remotely by using a suitable remote controller. (Refer to Section 4 for a description of FIREBERD remote control operation.)

With the required interface installed, the FIREBERD can be configured to perform in-service or out-of-service analysis of the circuit under test. Analysis results of the circuit under test are accumulated simultaneously and stored internally. Accumulated results can be viewed one at a time, with any two results displayed simultaneously on the front panel. If desired, a variety of printouts (e.g., results print or controls print) can be generated manually or automatically. (Refer to Section 3 for a description of the types of printouts available and how to generate them.)

## Getting Started

The FIREBERD uses digital interfaces to test T1, CCITT, DDS, and synchronous/asynchronous circuits and equipment. In addition to its versatility, the FIREBERD is very powerful, combining bit error rate testing with performance, signal, and timing analysis.

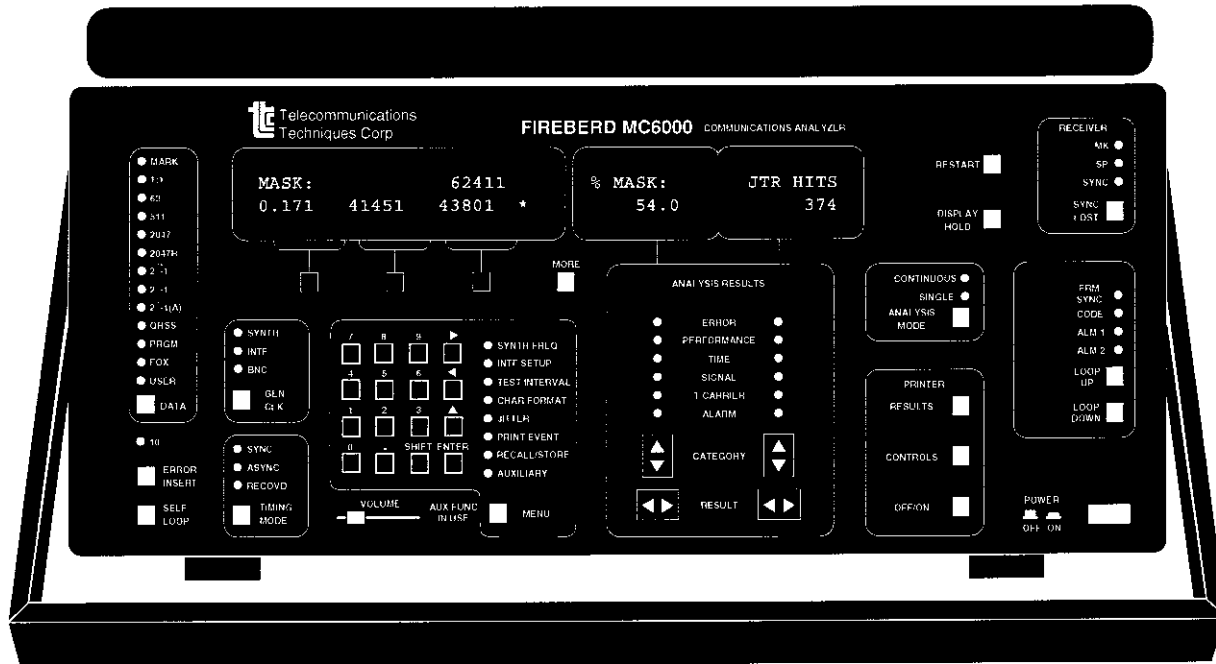

**Figure 1-1**  
**The FIREBERD 6000**

### 1.3 POWER REQUIREMENTS

The FIREBERD 6000 requires a power source of 90-135 or 195-250 VAC, single phase, 48 to 66 Hz that can deliver 120 volt-amperes (maximum). When shipped from the factory, the instrument is normally set to operate from a 120-volt power source. To operate the instrument from a different source voltage, do the following:

1. Remove the input power cord.
2. Slide the plastic door on the AC input connector to the left.
3. Pull on the FUSE PULL handle and gently remove the fuse.
4. Remove the voltage select module by pulling it straight out.
5. Rotate the orientation of the voltage select module 180°, and reinsert it to change the operating voltage range. The selected voltage (115 or 230) is readable when viewing the voltage selector module from the rear of the FIREBERD. The non-selected range is upside down. Sliding the FUSE PULL handle to the right covers up the non-selected voltage, leaving only the selected voltage visible.

6. Install the properly rated fuse for the selected voltage. Refer to Table 1-1 for the required fuse rating for each voltage selection. There is a label on the rear panel (see Figure 1-2) that also indicates the fuse rating for the operating voltage.

**Table 1-1  
Fuse Rating**

Operating Voltage:	Fuse Rating:
90-135 VAC	3A, 125 Volt, Slow Blow
195-250 VAC	1.5A, 250 Volt, Slow Blow

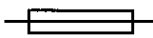
VOLTAGE SELECTOR	
100 OR 120	T 3A/250V
220 OR 240	T 1.5A/250V

**Figure 1-2  
Fuse/Voltage Selection Label**

7. Slide the plastic door to the right and reinsert the power cord.

## 1.4 GROUND JUMPER

The FIREBERD 6000 is equipped with a selectable ground jumper. When shipped from the factory, signal ground is connected to chassis ground through a 100 $\Omega$ , 1/2 watt resistor. If desired, the signal ground can be directly connected to chassis ground by repositioning the selectable jumper. Reposition the selectable jumper, changing the signal ground, by using the following procedure that is applicable for the type of FIREBERD 6000 that you have.

### 1.4.1 FIREBERD 6000/6000R (Plastic Case)

1. Remove the power cord from the FIREBERD.
2. Turn the unit upside down and remove the four screws from the bottom of the plastic case (located in the rubber feet).
3. Turn the unit right side up and remove the top cover by pressing on both sides of the top cover and pulling up.
4. Locate PC board #40442 immediately behind the front panel. The selectable ground jumper is located at the upper left corner on the component side of the board (see Figure 1-3).
5. Lift the jumper (JW1) from the three-position header (B position) and place it one position to the right (A position).
6. Put the top cover back into place, turn the unit upside down, and secure the cover by refastening the four screws in the bottom of the case.

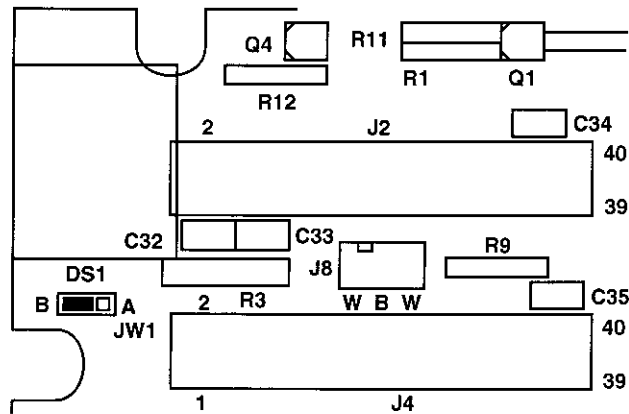

**Figure 1-3**  
**Component Side PC Board #40442 View of Upper Left Corner and Selectable Jumper Position**

### 1.4.2 FIREBERD MC6000 (Metal Case)

1. Remove the power cord from the FIREBERD.
2. Locate and remove the two screws (one on each side of the case) which secure the front bezel.  
**NOTE:** If the case is equipped with a handle, press the button on each side of the handle and rotate it downward; the front bezel screws (one on each side of the case) are now readily accessible.
3. Remove the front bezel by pulling forward.
4. Slide the top cover forward and lift out.
5. Locate PC board #40442 immediately behind the front panel. The selectable ground jumper is located at the upper left corner on the component side of the board (see Figure 1-3).
6. Remove the selectable jumper (JW1) from the 3-position header (B position) and install it one position to the right (A position).
7. Replace the top cover by sliding it through the guides on each side of the case. Ensure that the cover is seated properly into the rear of the FIREBERD.
8. Press the front bezel back in place and replace the two screws.

### 1.5 WARNINGS

The following precautions must be observed before and during all phases of operation. Failure to comply with these precautions or specific warnings located elsewhere in this manual can cause physical harm to the operator or damage to the unit. TTC assumes no liability for the customer's failure to comply with these requirements.

#### **GROUND THE INSTRUMENT**

To minimize shock hazard, connect the instrument chassis to an electrical ground. The instrument is equipped with a three-conductor AC power cable. The power cable must either be plugged into an approved three-contact electrical outlet or used with a three-contact to two-contact adaptor with grounding wire (green) firmly connected to an electrical ground (safety ground) at the power outlet.

### **USE PROPER LINE VOLTAGE SETTING AND FUSE SIZE**

Before connecting the AC power cord, verify that the line voltage selector module is positioned for the correct operating voltage. Do not operate the instrument with the incorrect fuse size.

### **KEEP AWAY FROM LIVE CIRCUITS**

Do not remove covers or insert fingers or other objects through the rear panel holes while power is applied to the instrument.

### **TURN OFF POWER BEFORE INSERTING OR REMOVING INTERFACE MODULES**

Damage can result if any modular interface is inserted into the FIREBERD 6000 when power is applied to the instrument.

### **DO NOT OPERATE IN AN AMBIENT TEMPERATURE ABOVE 50°C**

### **LITHIUM BATTERY INSTALLED**

The danger of explosion exists if the lithium battery is incorrectly replaced. Replace the lithium battery only with the same or equivalent type recommended by the manufacturer. Dispose of used batteries according to the manufacturer's instructions.

## **1.6 OPERATING CONVENTION**

The FIREBERD 6000 operation is determined by the interface selected and by the switch settings. The FIREBERD is configured by using the front panel controls or by using a suitable remote controller. Refer to Figure 1-1 for a front panel view of the FIREBERD 6000.

Two types of switches are used to select, control, and display unit operating conditions. Switch types are: pushbutton or rocker. Pushbutton switches control the associated function (e.g., **ERROR INSERT**, **PRINTER**, **DISPLAY HOLD**, or **MORE**) or cycle through a series of function-related choices (e.g., **DATA**, **MENU**, **GEN CLK**, or **TIMING MODE**). Rocker switches allow selection of a category or movement through menu choices for a selected category (e.g., **CATEGORY** or **RESULT SELECT**). When more than three menu items are available for a displayed menu, the LED in the **MORE** switch illuminates. Pressing the **MORE** switch displays the next menu item choice. **ANALYSIS RESULTS** menu items are cyclical. This means that repeatedly pressing the left or right arrow on the associated **RESULT** rocker switch scrolls through all result menu items for the selected category and begins cycling through again. Refer to Section 2 for an explanation of the switches and available choices.

## **1.7 TEST CONFIGURATION**

Due to the variety of interfaces that can be used with the FIREBERD 6000 and the type of tests that can be performed, only an overview of a typical test configuration will be described. The following steps are typically performed when conducting an out-of-service test with the FIREBERD 6000.

1. **DATA** - selects the data pattern to be inserted on the circuit under test.
2. **GEN CLK** - determines the transmit timing source.
3. **TIMING MODE** - determines the type of transmit and receive timing used by the interface.

## Getting Started

4. **MENU** - set the required categories for the interface selected and test to be performed.
  - SYNTH FREQ - selects the data rate when **GEN CLK** is set to SYNTH.
  - INTF SETUP - configures the selected interface for the test to be performed.
  - TEST INTERVAL - selects the number of bits or time for the intermediate test interval, or the time period for the test when **ANALYSIS MODE** is set to SINGLE.
  - CHARACTER FORMAT - sets the asynchronous data character format, when **TIMING MODE** is set to ASYNC (asynchronous).
  - JITTER - configures the jitter option parameters, when this option is installed.
  - PRINT EVENT - selects normal events or results accumulated for the test interval.
  - RECALL/STORE - allows up to 10 configurations to be saved and recalled.
  - AUXILIARY - allows a variety of features and controls to be determined.
5. **ANALYSIS MODE** - select the type of analysis to be performed.
6. Connect the cable(s) to the FIREBERD 6000.
7. **RESTART** - pressing this switch clears all accumulated results and begins the test.
8. Print out desired results.

Keep in mind that the FIREBERD configuration varies depending on the interface selected and the type of testing that is to be performed. For example, if the test to be performed is an in-service test, no data pattern needs to be selected.

## 1.8 INSTRUMENT CHECKOUT

The following paragraphs describe the automatic self-test that the FIREBERD 6000 performs at power-up, and also describes a manual self-test that can be used to verify proper operation of the FIREBERD. The following procedures assume that the user is familiar with the operation of the FIREBERD 6000; users unfamiliar with the FIREBERD operation should refer to Section 2 of this manual.

### 1.8.1 Automatic Self-Test

The automatic self-test is a series of diagnostic tests that are performed by the FIREBERD 6000 at power-up. These tests ensure that the instrument is functioning correctly. If any of these tests fail, the FIREBERD 6000 displays a message identifying the failed component.

#### **During the automatic self-test:**

- All discrete LEDs (except the MK and SP indicators), switches containing LEDs, and backlit panel labels are illuminated, and the software revision and date appear in the left display.
- All memory is tested. If an error is found, a message is displayed. If an EPROM error message appears, the unit may not operate. Call TTC for service.
- Switch positions are checked. If a switch is pressed or stuck during power-up, an error message identifies it. For example, holding the **DATA** switch in causes the message **KEY STUCK DATA** to be displayed for approximately one second. In such instances, the switch is not operational.
- Non-volatile RAM (NOVRAM) is checked to restore the switch settings that were in effect when the unit was turned off. If any changes are detected, a message specifies what general portion of NOVRAM failed, and the original factory settings are automatically restored for the affected portions of NOVRAM. Note that the FIREBERD 6000 may still be fully operational even though switch settings are not saved during a power cycle.

## 1.8.2 Manual Self-Test

Manual self-tests ensure that the individual components of the FIREBERD 6000 are working properly. TTC recommends the use of the internal RS-232/V.24 Interface for this test. If, however, the RS-232 Interface is not desired to be used, a modular interface can be substituted. Procedures found later in this section describe the set-up procedure for the internal RS232 Interface. If an optional interface is installed, refer to the appropriate interface operating manual for information on specific interface set-up.

**REMINDER:** Turn the FIREBERD 6000 power OFF before inserting or removing any module or interface.

Before beginning any manual self-test procedure, verify that:

- The automatic self-test is successful.
- The AC line voltage card is set properly.
- If required, the modular interface is properly installed.
- The power to the unit is ON.

The following self-test procedures can be performed in sequential order or individually as required:

- Frequency synthesizer and frequency counter self-test.
- Synchronous transmit and receive self-test.
- Error counter and error insert self-test.
- Seconds and blocks self-test.
- Data generator self-test.

**NOTE:** If any self-test indicates that the instrument requires service, please note the area(s) of the test the FIREBERD 6000 failed before contacting TTC for assistance.

### Frequency Synthesizer and Frequency Counter Self-Test

To test the FIREBERD 6000 frequency synthesizer and the frequency counter, perform the following steps:

1. Press the **SELF LOOP** switch to enable the self-loop mode. Make sure that the LED in the switch is illuminated.
2. Set the **DATA** switch to the 2<sup>23</sup>-1 position.
3. Set the **GEN CLK** switch to the SYNTH position.
4. Set the **TIMING MODE** switch to the SYNC position.
5. Set the **MENU** switch to the INTF SETUP position.

**RESULT:** An interface menu is visible in the display above the keypad.

6. Press the softkey below the INT232 menu item.
7. Press the softkey below the EMULATE menu item.

## Getting Started

8. Press the softkey below the DTE menu item.  
**RESULT:** Interface set-up is complete.
9. Set the **MENU** switch to the SYNTH FREQ category.
10. Press the illuminated **MORE** switch until 64 is visible as a menu item selection.
11. Press the softkey below the 64 menu item to set the synthesizer frequency to 64 kHz.
12. In the ANALYSIS RESULTS area, set both **CATEGORY** switches to the SIGNAL category.
13. Press the right **RESULT** switch until RCV FREQ is visible in the right portion of the display.
14. Press the left **RESULT** switch until GEN FREQ is visible in the left portion of the display.
15. Set the **ANALYSIS MODE** switch to the CONTINUOUS position.
16. Verify that the ANALYSIS RESULTS display show the following:

GEN FREQ	RCV FREQ
64000.0	64000.0

## Synchronous Transmit and Receive Self-Test

To verify the operation of the FIREBERD 6000 transmit and receive circuitry, perform the following steps:

1. If the  $10^{-3}$  indicator (located below the **DATA** switch) is illuminated, press the **ERROR INSERT** switch to turn it off.
2. In the ANALYSIS RESULTS area, set the right **CATEGORY** switch to the ERROR category.
3. Press the right **RESULT** switch until BIT ERRS is visible in the right portion of the display.
4. Press the **RESTART** switch and verify that:
  - The SYNC indicator is illuminated.
  - The bit error display shows 0 errors.
  - The SYNC LOST indicator LED is off.

## Error Counter and Error Insert Self-Test

To verify the operation of the FIREBERD 6000 error counter and error insert function, perform the following steps:

1. If the  $10^{-3}$  indicator (located below the **DATA** switch) is illuminated, press the **ERROR INSERT** switch to turn it off.
2. In the ANALYSIS RESULTS area, set the right **CATEGORY** switch to the ERROR position.
3. Press the right **RESULT** switch until BIT ERRS is visible in the right portion of the display.
4. Press the **ERROR INSERT** switch once and verify that the BIT ERRS count has increased from 0 to 1.
5. Adjust the volume control (located to the right of the **TIMING MODE** switch) until the unit “beeps” when the **ERROR INSERT** switch is pressed.



6. Hold the **ERROR INSERT** switch pressed in until the  $10^{-3}$  indicator illuminates and verify that the BIT ERRS count is increasing rapidly. An audible tone is generated during every second that errors are inserted. The **VOLUME** control adjusts the audio tone.
7. Set the **MENU** switch to the TEST INTERVAL position.
8. If not visible in the display, press the illuminated **MORE** switch until the  $10^6$  menu item is visible.
9. Press the softkey below the  $10^6$  menu item.
10. Press the right **RESULT** switch until the BER result is visible in the display. Wait approximately 15 seconds, then verify that the BER result is 1.00 E-03.

### Seconds and Blocks Self-Test

To self-test the FIREBERD 6000 for seconds and blocks measurements, perform the following steps:

1. Set the **MENU** switch to the SYNTH FREQ position. Using the keypad, press the number **1** key and then press **ENTER**.
2. In the ANALYSIS RESULTS area, set the left **CATEGORY** switch to the TIME position.
3. Press the left **RESULT** switch until EF EAS is visible in the left portion of the display.
4. If the  $10^{-3}$  indicator (located below the DATA switch) is illuminated, press the **ERROR INSERT** switch to turn it off.
5. Set the **MENU** switch to the AUXILIARY position. Using the keypad, press the number **3** and **0** keys and press **ENTER**. This places you in the Block Length menu. Press the **1, 0, 0,** and **0** number keys (1000) and press **ENTER** to confirm 1000 as the new block length.
6. Press the **RESTART** switch and verify that the EF EAS count in the left display is increasing by 1 each second.
7. Set the right **CATEGORY** switch to the TIME category.
8. Press the right **RESULT** switch until EA SEC is visible in the right portion of the display. Verify that the EA SEC count is identical to that of EF EAS.
9. Set the right **CATEGORY** switch to the ERROR position. Using the right **RESULT** switch, check the right portion of the display to verify that these results are being measured correctly:

BLK ERRS	0
BLOCKS	Identical to EA SEC

### Data Generator Self-Test

To verify the operation of the data generator, perform the following steps:

1. Set the **DATA** switch to the MARK position.
2. Set the **MENU** switch to the SYNTH FREQ category. Using the keypad, press the . (decimal point), **0,** and **5** number keys (.05) and then press **ENTER**.
3. Verify that the MK indicator (located in the top right corner of the unit) is illuminated.
4. Press the **ERROR INSERT** switch several times and verify that the SP indicator (located below the MK indicator) briefly illuminates.

## Getting Started

5. Set the **DATA** switch to the 1:1 position; verify that the MK and SP indicators are both flashing.
6. Using the keypad, change the synthesizer frequency to 5 kHz by pressing the **5** number key and press **ENTER**.
7. Press the **DATA** switch to scroll through all pattern positions; verify that the SYNC indicator is illuminated for each position except FOX\* and USER\*.

\*SYNC indicator illuminates in FOX and USER positions when the Long User Pattern upgrade (i.e., 2048-character, user-programmable message) is installed.

## Time and Date Self-Test

To verify that the FIREBERD 6000 is recording the correct time and date, perform the following steps:

1. Press the left **RESULT** switch until TIME is visible in the left portion of the display; verify that the display shows the correct time.
2. Press the right **RESULT** switch until DATE is visible in the right portion of the display; verify that the display shows the correct date.

**NOTE:** If the time and date are not accurate, they can be reset using auxiliary function 60. (Refer to Section 2 for a description of this auxiliary function and all other auxiliary functions.)

## 1.9 INTERFACE SELECTION

The FIREBERD 6000 requires an interface to be selected in order to perform data analysis. The selected interface provides the physical connection to the circuit under test, provides the proper termination, and allows access to framing, signaling, and other parameters necessary to connect to the circuit under test.

The internal RS232 Interface is the standard interface in every FIREBERD 6000. Any other optional interface must be inserted into the interface slot, located in the rear panel of the FIREBERD. With no optional interface installed, pressing the **MENU** switch until the LED next to the INTF SETUP label is illuminated displays the available interface (INT232) in the display window. Pressing the softkey below the INT232 menu item selects the internal RS232 Interface as the active interface.

### 1.9.1 Internal RS232 Interface

After selecting the internal RS232 Interface as the active interface, the EMULATE menu item is visible on the bottom line. Press the softkey below the emulate menu item to select whether the FIREBERD is to emulate DCE (Data Communications Equipment) or DTE (Data Terminal Equipment). Pressing the softkey below the DTE menu item selects DTE emulation and backlights the EMULATE DTE label and the labels in the column below EMULATE, located at the right on the front panel.

### DTE Operation Overview

In a typical RS-232-C circuit, the DCE supplies the timing source to the FIREBERD (emulating DTE) on the TC (Transmit Clock) lead on pin 15. Refer to Table 1-2 for the connector pin assignments and Figure 1-4 for the pin location. Connect the circuit under test to the rear panel RS-232 connector labeled TO DCE. When the interface clock is being used as the source of timing, the FIREBERD generates TD (Transmitted Data) on pin 2 and XTC (Transmit Clock) on pin 24 coincident with the clock received on the TC lead.

When the FIREBERD synthesizer is used as the timing source, the FIREBERD ignores the TC lead and generates TD and XTC coincident with the selected internal synthesizer (SYNTH FREQ) rate. The BNC input, located on the rear panel, may also be used to supply generator timing. Data and clock signals received on the RD and RC leads are used for error analysis.

Two switches (**RTS** and **DTR**) on the FIREBERD front panel allow the RTS (Request to Send) and DTR (Data Terminal Ready) leads, pins 4 and 5 respectively, to be turned on or off. When the LED in the switch is turned on, the lead status is a logic HIGH and when the lead status is a logic LOW, the LED in the switch is off. The status of the Clear to Send (CTS), Data Set Ready (DSR), and Received Line Signal Detector (RLSD) are also displayed on the FIREBERD front panel.

**Table 1-2**  
**RS-232-C Connector Pin Assignments**

Pin No.:	Designations:		Signal Description:	Signal Direction:	
	EIA	CCITT		TO DCE	TO DTE
1	AA	101	Protective Ground	Connected to chassis ground	
2	BA	103	Transmitted Data (TD)	Output	Input
3	BB	104	Received Data (RD)	Input	Output
4	CA	105	Request to Send (RTS)	Output	Input
5	CB	106	Clear to Send (CTS)	Input	Output
6	CC	107	Data Set Ready (DSR)	Input	Output
7	AB	102	Signal Ground	Connected to signal ground	
8	CF	109	Received Line Signal Detector (RLSD)	Input	Output
15	DB	114	Transmit Clock, DCE source (TC)/ Send Timing (ST)	Input	Output
17	DD	115	Receive Clock, DCE source (RC)	Input	Output
20	CD	108/2	Data Terminal Ready (DTR)	Output	Input
22	CE	125	Ring Indicator (RI)	Output	Input
24	DA	113	Transmit Clock, DTE source (XTC)/Terminal Timing (TT)	Output	Input

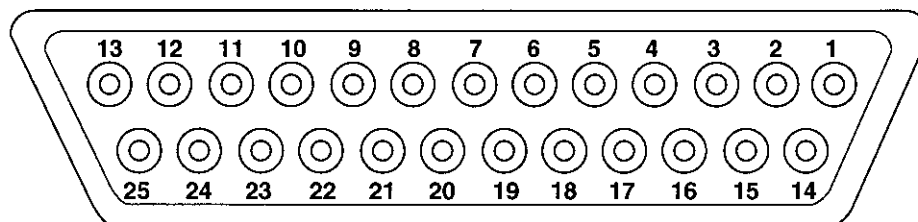

**Figure 1-4**  
**RS-232 Connector**

### DCE Operation Overview

In a typical RS-232-C circuit, the FIREBERD (emulating DCE) supplies timing to the DTE on the TC lead. Connect the circuit under test to the rear panel RS-232 connector labeled TO DTE. The DTE returns TD and XTC to the FIREBERD for error analysis.

When the interface clock is being used for generator timing, RD and RC are generated coincident with XTC from the DTE. The FIREBERD may also generate RD and RC coincident with the synthesizer rate or the BNC rate.

Two switches (**RLSD** and **DSR**) on the FIREBERD front panel allow the RLSD and DSR leads to be turned on or off in the DCE mode. DTR and RTS are received and their status is displayed on the FIREBERD front panel. When the LED in the switch is turned on, the lead status is a logic HIGH and when the LED in the switch is off, the lead status is a logic LOW.

## Getting Started

Pressing the softkey below the DCE menu item selects DCE emulation, backlights the EMULATE DCE label; the labels in the column below EMULATE, located at the right on the front panel, displays the RI and CTS menu, and their status. Refer to Figure 1-5 for a view of the RS232 menu and its selections. Pressing the softkey below the RI (Ring Indicator) or CTS (Clear to Send) softkey displays the corresponding menu item selections. CTS (pin 5) and RI (pin 22), on the RS-232-C connector, can be turned on or off from the DCE menu. Both the RI and CTS menu items can be set off or on. When set ON, the corresponding RS-232-C connector is set TRUE. Setting either menu item OFF sets the corresponding connector pin FALSE. In addition to the ON and OFF menu selections, the CTS menu item has an AUTO selection. Selecting AUTO allows the FIREBERD to automatically assert RTS TRUE when CTS is sensed to be TRUE.

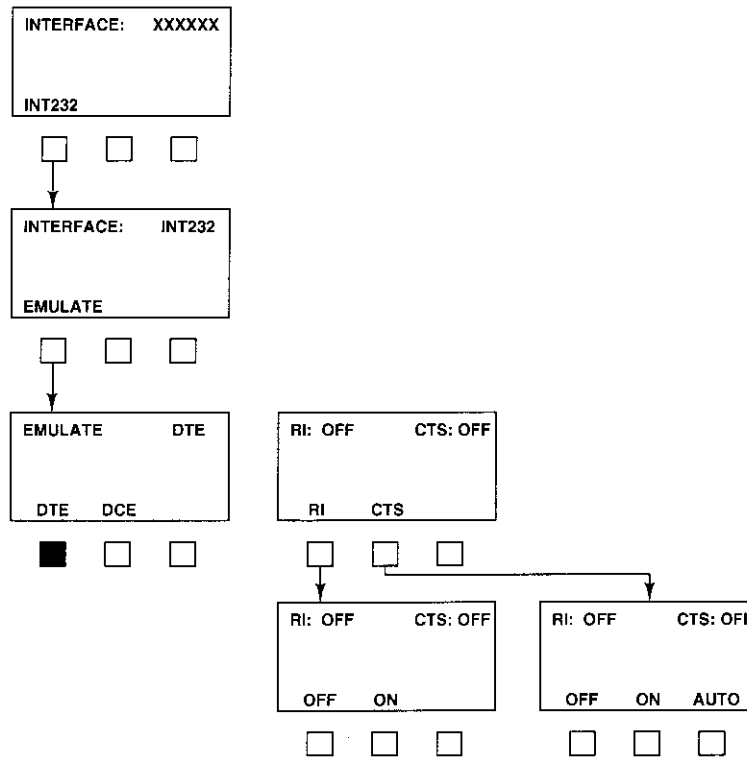

**Figure 1-5**  
**Internal RS232 Menu**

### Internal RS232 Synchronous Operation

The internal RS232 Interface can be operated in synchronous mode by pressing the **TIMING MODE** switch to illuminate the LED next to the SYNC label. In synchronous mode, the SYNTHFREQ, GENCLK, and DATA menus need be set. The SYNTHFREQ determines the data rate and can be set to frequencies from 50 b/s to 64 kb/s. Press the **GEN CLK** switch to select the generator clock timing source (SYNTH, INTF, or BNC). The DATA menu determines the data pattern that is transmitted by the FIREBERD. Any data pattern is valid. The FOX and USER 1-3 patterns may require the LUP upgrade to be installed.

To configure the mainframe for synchronous DTE operation, select the INT232 Interface menu from the INTF SETUP category, and press the softkey below the EMULATE menu item. Press the softkey below the DTE menu item to select DTE emulation. Set the **TIMING MODE** selection to SYNC. An additional step is required to select the timing source used to clock-in the transmitted data (pin 2). Connect the interface cable to the TO DCE connector on the rear panel. Refer to Table 1-2 to verify connector pin assignments.

To configure the mainframe for synchronous DCE operation, select the INT232 Interface menu from the INTF SETUP category, and press the softkey below the EMULATE menu item. Press the softkey below the DCE menu item to select DCE emulation. Set the **TIMING MODE** selection to SYNC. An additional step is required to select the timing source used to clock-in the transmitted data (pin 2). Connect the interface cable to the TO DTE connector on the rear panel. Refer to Table 1-2 to verify connector pin assignments.

During DCE or DTE emulation, two switches, located on the right of the front panel, control RLSD (Receive Line Signal Detector) and DSR (Data Set Ready) for DCE emulation or RTS (Ready to Send) and DTR (Data Terminal Ready) for DTE emulation. Pressing the associated pushbutton alternately illuminates and extinguishes the LED in the pressed switch. When the LED in the switch is illuminated, the lead is forced TRUE, and when the LED is extinguished, the lead is forced FALSE.

In addition to the selections described previously, several auxiliary functions affect synchronous operation. The auxiliary function number and the corresponding description are as follows:

<u>Auxiliary Function:</u>	<u>Description:</u>
01	Generator clock polarity
02	Receiver clock polarity
03	Receiver action on synchronization loss
04	Signal transmit
06	Generator data inversion
07	Receiver clock selection
08	Out-of-band flow control
10	Synchronization loss threshold
30	Block length
31	Signal delay
33	Programmable patterns
41	User message selection

For additional information on these auxiliary functions, refer to Section 2.

### Internal RS232 Asynchronous Operation

The internal RS232 Interface can be operated in asynchronous mode by pressing the **TIMING MODE** switch to illuminate the LED next to the ASYNC label. The FIREBERD operates in asynchronous mode at data rates from 50 b/s to 20 kb/s. In asynchronous mode, the SYNTH FREQ, CHAR FORMAT, and DATA menus need to be set. The SYNTH FREQ determines the data rate and must be set to less than 20 kHz. If a synthesizer frequency greater than 20.0 kHz is selected, the message: **Async Frequency Contention** is flashed in the right display window. Setting the synthesizer frequency to less than 20.0 kHz eliminates the contention message. The CHAR FORMAT menu sets the number of data bits (5, 6, 7, or 8), parity (odd, even, or odd), and the number of stop bits (1, 1.5, or 2). The DATA menu determines the data pattern that is transmitted by the FIREBERD. Valid asynchronous data patterns are: MARK, 1:1, 63, 511, 2047, 2<sup>15</sup>-1, FOX, and USER 1-3. If an invalid pattern is selected, the message: **Async Pattern Contention** is flashed in the right display window. Selecting a valid data pattern eliminates the contention message.

To configure the mainframe for asynchronous DTE/DCE operation, select the INT232 Interface menu item from the INTF SETUP category, and press the softkey below the EMULATE menu item. Then press the softkey below the DTE or DCE menu item. Set the **TIMING MODE** menu to ASYNC. When ASYNC is selected, the CHAR FORMAT category menu item selections for the number of data bits (5, 6, 7, or 8), parity (EVEN, ODD, or NONE), and stop bits (1, 1.5, or 2) must also be set. These parameters need to match the parameters of the equipment being tested. In-band flow control (auxiliary function 09) is selectable for both DTE and DCE emulation. RI and CTS lead control is available with DCE emulation. Connect the interface cable to the appropriate rear panel connector (TO DCE or TO DTE). Refer to Table 1-2 to verify connector pin assignments.

## Getting Started

Set the **GEN CLK** to **SYNTH** and select the appropriate clock frequency to match the required data rate. Do not use the **INTF** or **BNC** selections when operating asynchronously.

To select the desired test pattern, press the **DATA** switch to select and illuminate the LED next to the desired data pattern. The following patterns are valid in asynchronous testing: **MARK**, **SPACE**, **1:1**, **63**, **511**, **2047**, **2<sup>15</sup>-1**, **FOX**, and **USER1-3**. If any other pattern is selected, **ASYNC PATTERN CONTENTION** flashes in the **ANALYSIS RESULTS** display.

During DCE or DTE emulation, two switches, located on the right of the front panel, control **RLSD** (Receive Line Signal Detector) and **DSR** (Data Set Ready) for DCE emulation or **RTS** (Ready to Send) and **DTR** (Data Terminal Ready) for DTE emulation. Pressing the associated pushbutton alternately illuminates and extinguishes the LED in the pressed switch. When the LED in the switch is illuminated, the lead is forced **TRUE**, and when the LED is extinguished, the lead is forced **FALSE**.

In addition to the selections described previously, several auxiliary functions affect synchronous operation. The auxiliary function number and the corresponding description are as follows:

<u>Auxiliary Function:</u>	<u>Description:</u>
03	Receiver action on synchronization loss
04	Signal transmit
06	Generator data inversion
08	Out-of-band flow control
09	In-band flow control
10	Synchronization loss threshold
30	Block length
31	Signal delay
33	Programmable patterns
41	User message selection
46	Async data timeout

For additional information on these auxiliary functions, refer to Section 2.

### 1.9.2 Optional Interface Installation

The following procedure describes the steps for installing an interface module in a **FIREBERD 6000**. Refer to Figure 1-6 for the interface slot location. Section 5 provides a complete list of interfaces currently supported by the **FIREBERD 6000**.

#### CAUTION

#### **TURN THE MAINFRAME POWER OFF BEFORE INSTALLING THE INTERFACE MODULE IN THE FIREBERD.**

1. Ensure that the **POWER** switch, on the **FIREBERD** front panel, is in the **OFF** position.
2. Turn the **FIREBERD 6000** around to expose the vacant rear panel interface slot.
3. Insert the interface module into the vacant interface slot, with the printed circuit (PC) board facing up. The PC board edges fit into slides on either side at the top edges of the interface slot.
4. Press the interface module firmly into the mainframe mating connector, until the back of the interface faceplate is flush with the mainframe rear panel.
5. Secure the interface module in the mainframe by turning the two thumbscrews on the interface front panel clockwise, until finger tight.

This completes the interface installation procedure. The installed interface can be selected from the front panel by pressing the **MENU** switch to illuminate the LED next to the INTF SETUP label and then pressing the softkey below the installed interface label. Refer to Section 4 of this manual or the interface operating manual on how to remotely select the installed interface.

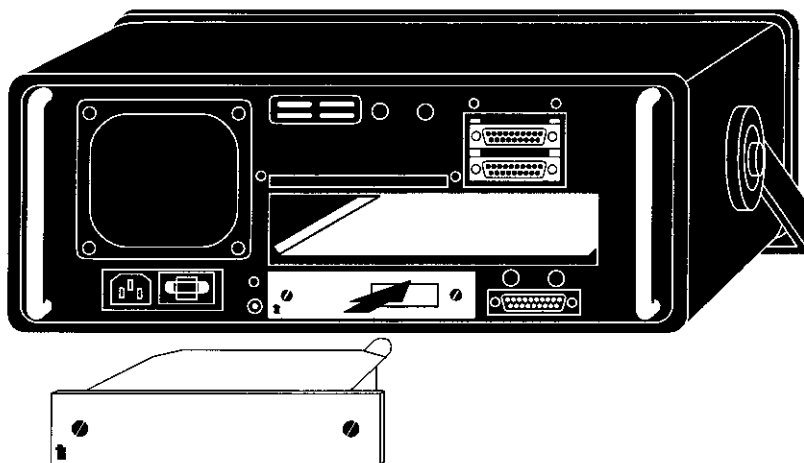

**Figure 1-6**  
Installing an Optional Interface Module in a FIREBERD 6000

### 1.9.3 Interface Installation with an ISU

Using the FIREBERD 6000 with an ISU (Interface Switching Unit) allows multiple interfaces to be installed in the ISU and selected one at a time. Up to four interfaces can be installed in an ISU and selected from the FIREBERD front panel or remotely by using a remote controller. Refer to Section 4 for a description of remotely controlling the FIREBERD.

The following procedure describes the steps required to select an interface that is installed in an ISU.

1. Ensure that the **POWER** switch, on the FIREBERD front panel, is in the OFF position.
2. Turn the FIREBERD 6000 around to expose the vacant rear panel interface slot.
3. Insert the Cable Interface Adaptor module into the vacant interface slot, with the printed circuit (PC) board facing up. The PC board edges fit into slides on either side at the top edges of the interface slot.
4. Press the Cable Interface Adaptor module firmly into the mainframe mating connector, until the back of the adaptor faceplate is flush with the mainframe rear panel.
5. Secure the adaptor module in the mainframe by turning the two thumbscrews on the interface front panel clockwise, until finger tight.
6. Install and secure the interface(s) in the ISU slot(s).
7. Turn the FIREBERD and ISU power on.

**1.9.4 Selecting an Interface in the ISU**

With the desired interface installed in the ISU, and power applied to the ISU and FIREBERD, perform the following procedure to select the interface.

1. Press the **MENU** switch to illuminate the LED next to the INTF SETUP label.
2. Press the softkey below the ISU menu item to select the ISU as the selected interface.
3. ISU is visible on the top line and S1, S2, and S3 displayed on the bottom line. The LED in the **MORE** switch is illuminated, indicating that additional menu items are available. Press the **MORE** switch to display the S4 menu item. S1 to S4 indicate the interface slot in the ISU.
4. As an example, assume that the DS1/T1 Interface is installed in ISU slot 2 (S2) and this is the interface that is to be selected. In this example, press the softkey below the S2 menu item to select the DS1/T1 Interface.
5. The top line now displays INTF: ISU, S2, DS1/T1 and the LED above interface slot 2 in the ISU is illuminated.



1

1



## SECTION 2 INSTRUMENT DESCRIPTION

### 2.1 SECTION SUMMARY

This section provides an instrument description, provides an explanation of each switch, and describes menus and messages that are visible in the display windows.

### 2.2 FUNCTIONAL DESCRIPTION

The FIREBERD 6000 Communications Analyzer is a multifunction analyzer that uses modular interfaces to access a wide variety of circuits for analysis. Selecting an optional interface, installed in the rear panel interface slot, or the internal RS232 Interface allows the FIREBERD 6000 to connect to a circuit and perform in-service analysis or out-of-service BER (bit error rate) testing. All controls for configuring the FIREBERD 6000 are located on the front panel and are grouped according to function.

Menus, messages, and configuration information are displayed on the front panel on an 80-character, vacuum florescent display. The display window is divided in half, with the left half providing configuration information, such as interface selection and other configuration settings. The right half of the display permits two analysis results to be displayed at one time.

After configuring the FIREBERD 6000 for the test to be performed, attach the circuit to be tested to the selected interface. Observe the LEDs located at the right of the FIREBERD front panel. The MK (Mark) and SP (Space) LEDs illuminate when the corresponding signal activity is detected. If a pattern is being transmitted and DATA is set for the same pattern, the SYNC (pattern synchronization) LED, located below the SP LED, illuminates when pattern synchronization is declared.

**NOTE:** Depending on the interface selected and the type of testing being performed (i.e., standard or live) not all of these LEDs will necessarily be illuminated. For example, the FRM SYNC (frame synchronization) LED illuminates when frame synchronization is achieved only on frame-compatible interfaces.

After connection and full synchronization has been achieved, pressing the **RESTART** switch clears all accumulated results and starts another test period. The time the test runs is determined by the **ANALYSIS MODE** (SINGLE or CONTINUOUS) and the **TEST INTERVAL** selections, either a number of bits ( $10^4$  to  $10^{10}$ ) or TIMED (up to 24 hours).

Using the four **ANALYSIS RESULTS** rocker switches (two for **CATEGORY** and two for **RESULT**), the accumulated results from the selected category can be scrolled through. Pressing the **DISPLAY HOLD** switch allows the displayed result values to be halted. The LED in the **DISPLAY HOLD** switch illuminates to indicate that the displayed result values are not the current values. This allows the operator to view all accumulated result values that were current at that point in time. Even though the displayed result values are halted, the current values continue to accumulate. Pressing the **DISPLAY HOLD** switch again extinguishes the LED in this switch and updates the result values to their current value.

If a printout of the current operating control settings or result values is desired, press the **PRINTER ON/OFF** switch to illuminate the LED in this switch and then press the **RESULTS** or **CONTROLS** switch to generate the associated printout. Pressing the **RESULTS** switch generates a manual results printout listing a series of result values. Pressing the **CONTROLS** switch generates a printout of the current FIREBERD switch settings. This allows the unit configuration to be verified without having to scroll through all of the available MENU categories. If desired, the unit configuration can be saved through the RECALL/STORE category operation. Press the **MENU** switch to illuminate the LED next to the RECALL/STORE category. Press the softkey below the STORE menu item and then press the softkey below the number (0 to 9) where the configuration is to be stored. Additional information on the RECALL/STORE operation is contained later in this section.

## ***Instrument Description***

The printout generated is determined by the PRINT EVENT setting, and the following auxiliary menu selections.

11	I/O Driver Select
35	Results Print
36	Status Print
37	Printout Format
38	RS-232

Depending on the settings of these auxiliary functions determines what causes a printout, when a printout is generated, the printout format, and what is included in a printout. The auxiliary functions are described later in this section and printout samples can be found in Section 3.

## **2.3 SPECIFICATIONS**

### **2.3.1 Modes of Operation**

- |                       |   |
|-----------------------|---|
| Emulation:            | <ul style="list-style-type: none"><li>• Emulate DTE mode (for connection to DCE).</li><li>• Emulate DCE mode (for connection to DTE).</li></ul> |
| System Configuration: | <ul style="list-style-type: none"><li>• Full-Duplex mode.</li><li>• Single Transmit mode.</li><li>• Self-Loop mode.</li></ul>                   |
| Timing Modes:         | <ul style="list-style-type: none"><li>• Synchronous Timing.</li><li>• Asynchronous Timing.</li><li>• Recovered Timing (optional).</li></ul>     |

### **2.3.2 Generator Timing Systems**

- |                 |   |
|-----------------|---|
| Timing Modes:   | <ul style="list-style-type: none"><li>• Synchronous (1x bit rate clock generated for bit rates from 50 to 15,000,000 b/s). Optionally to 52 Mb/s with the HSSI Data Interface installed.</li><li>• Asynchronous (16x bit rate clock used by USART for bit rates from 50 to 20,000 b/s).</li><li>• Recovered (1x bit rate clock generated for bit rates from 50 to 520,000 b/s).</li></ul> |
| Timing Sources: | <ul style="list-style-type: none"><li>• Internal frequency synthesizer.</li><li>• GEN CLK IN rear-panel BNC connector.</li><li>• Data interface.</li></ul>  |
| Indicator:      | <ul style="list-style-type: none"><li>• LED within the <b>GEN CLK</b> switch illuminates when no generator clock signal is present.</li></ul>   |

### **2.3.3 Frequency Synthesizer**

- |                         |   |
|-------------------------|---|
| Frequency Range:        | <ul style="list-style-type: none"><li>• 50.00 Hz to 15.000 MHz (16x bit rate clock generated in the 16x Asynchronous timing mode for bit rates from 50 to 20,000 b/s).</li></ul>          |
| Resolution:             | <ul style="list-style-type: none"><li>• 5 significant digits (for frequencies that begin with 10 through 15).</li><li>• 4 significant digits (all other frequencies).</li></ul>           |
| Accuracy and Stability: | <ul style="list-style-type: none"><li>• <math>\pm 5</math> ppm (<math>\pm 1</math> ppm optional).</li><li>• <math>\pm 5</math> ppm/year (<math>\pm 1</math> ppm/year optional).</li></ul> |

**2.3.4 GEN CLK IN Rear Panel BNC Connector**

- Input Configuration
  - Outer conductor — ground.
  - Inner conductor — signal.
- Input DC Impedance:
  - 1000 ohms.
- Input AC Impedance:
  - 50 ohms.
- Input Signal Range:
  - 1.5 volts p-p to 25 volts p-p.

**2.3.5 GEN CLK OUT Rear Panel BNC Connector**

- Output Configuration:
  - Outer Conductor — ground.
  - Inner Conductor — signal.
- Output Load:
  - 50 ohms minimum.
- Output Signal Levels:
  - TTL Levels - 2.0 volts minimum high level, 0.4 volts maximum low level (50-ohm load).

**2.3.6 Data Generator**

- Fixed Patterns:
  - Mark.
  - 1:1.
  - User-programmable, 3- to 24-bit repeating pattern.
  - 1:7.
  - 3-in-24.
  - DDS-1 to DDS-6 (DDS-specific patterns).
  - T-1 to T-6, T1 DALY, and T1 - mW (T1 - specific patterns).
  - Tone (1004 Hz and 1020 Hz).
- Pseudorandom Patterns:
  - 63 ( $2^6-1$ ).
  - 511 ( $2^9-1$ ).
  - 2047 ( $2^{11}-1$ ).
  - $2^{15}-1$  (32, 767).
  - $2^{20}-1$  (1,048, 575).
  - $2^{23}-1$  (8, 388, 607).
  - QRSS.
- Messages:
  - FOX Message (in Baudot, BCDIC, ASCII, or EBCDIC depending on code level selected).
  - Three user-programmable messages each up to 2048 characters in length.
- Character Format  
(Asynchronous  
Timing mode):
  - Code Level 5, 6, 7, 8 bits.
  - Parity — odd, even, none.
  - Stop Bits — 1, 1.5, 2 bits.
- Data Inversion:
  - Available by auxiliary function for transmitted data.
- Error Insertion:
  - Single error or fixed  $10^{-3}$  bit error rate in generated data only.
- Full-Duplex  
Bit Rates:
  - Messages and/or Asynchronous timing mode — 50 to 20,000 b/s.
  - Synchronous timing mode — 50 to 15,000,000 b/s.

## ***Instrument Description***

### **2.3.7 Receiver Timing Systems**

- Timing Modes:
- Synchronous (1x bit rate clock received through data interface for bit rates from 50 to 15,000,00 b/s). Or optionally to 52,000,000 b/s with the HSSI Data Interface installed.
  - Asynchronous (16x bit rate clock internally provided for USART for bit rates from 50 to 20,000 b/s).
  - Recovered (1x bit rate clock recovered from data transitions for bit rates from 50 to 520,000 b/s).
- Timing Sources:
- Data interface.
  - Clock Recovery option.
- Indicators:
- NO CLK backlit label illuminates when receiver clock is not present.
  - CLK INV backlit label illuminates when the clock-data phasing at the input of data interface is the opposite of that required by the applicable interface standard.

### **2.3.8 Data Error Analysis**

- Analysis Modes:
- Single.
  - Continuous.
- Indicators:
- Receiver Inputs:
    - MK indicator illuminates when a Mark is received by the FIREBERD.
    - SP indicator illuminates when a Space is received by the FIREBERD.
    - SYNC indicator illuminates when pattern sync is achieved.
  - DATA INV backlit indicator illuminates when the data received by the FIREBERD is inverted from what is expected.
  - SYNC LOST LED (latching with pushbutton reset) is illuminated when a sync loss occurs.
- Sync Acquisition Criteria  
(Synchronous,  
Recovered  
Timing Modes):
- Fixed pattern data — 30 consecutive bits with no errors.
  - Pseudorandom pattern data —  $30 + n$  consecutive bits with no errors for a  $2^n - 1$  pattern.
  - User-programmable messages — dependent upon auxiliary function 45.
- Sync Acquisition Criteria  
(Asynchronous Timing  
Mode):
- Fixed pattern data, pseudorandom pattern data, and messages — 10 consecutive characters with no errors.
- Sync Loss Criteria  
(Synchronous,  
Recovered  
Timing Modes):
- Low Sync Loss Threshold 100 bit errors in less than 1000 bits of data.
  - Medium Sync Loss Threshold 250 bit errors in less than 1000 bits of data.
  - High Sync Loss Threshold 20,000 bit errors in less than 100,000 bits of data.
- Sync Loss Criteria  
(Asynchronous  
Timing Mode):
- Low and Medium Sync Loss Thresholds — 30 character errors in less than 60 received characters.
  - High Sync Loss Threshold — 20,000 bit errors in less than 100,000 received bits.

**2.3.9 Error Analysis**

Categories Available:  
(with appropriate  
data interface)

- ERROR.
- PERFORMANCE.
- TIME.
- SIGNAL.
- T-CARRIER.
- ALARM.

**2.3.10 BER Test Intervals**

- $10^4$ ,  $10^5$ ,  $10^6$ ,  $10^7$ ,  $10^8$ ,  $10^9$ , or  $10^{10}$  bits.
- Timed Tests Intervals — 1 second to 24 hours, 1-second resolution.

**2.3.11 Block Lengths**

- $10^2$  to  $10^6$  bits, 1-bit resolution.

**2.3.12 Signal Analysis**

Frequency Range:

- 50 Hz to 16 MHz, optionally to 52 MHz (with the HSSI Data Interface installed).

Resolution:

- less than 1,000 Hz - 0.001 Hz.
- 1,000 Hz to 9,999.99 Hz - 0.01 Hz.
- 10,000.0 Hz to 99,999.0 Hz - 0.1 Hz.
- greater than 100,000 Hz - 1 Hz.

Accuracy:

- $\pm 5$  ppm ( $\pm 1$  ppm optional).

**2.3.13 Delay Measurements**

Start of Measurement

Signal Sources:

- DTR.
- DSR.
- RTS.
- RLSD.
- CTS (emulate DCE only).
- Generator Data.
- Generator Pattern Sync test point.
- Delay Start test point.

End of Measurement

Signal Sources:

- DTR.
- DSR.
- RTS.
- CTS (emulate DTE only).
- RLSD.
- Receiver Data.
- Receiver Pattern Sync test point.
- Delay Stop test point.

## ***Instrument Description***

- Edge Selection: • Rising (off-to-on) or falling (on-to-off) edge selectable for both start and end of measurement signals (except pattern sync test points).
- Measurement Range: • 0 to 9,999.9 milliseconds.
- Resolution and Accuracy: •  $\pm 0.1$  millisecond.

### **2.3.14 Clock Recovery System**

(With the Clock Recovery Option Installed)

- Bit Rates: • 50 b/s to 520 kb/s.
- Clock Recovery Acquisition/  
Tracking Range: •  $\pm 1\%$  of selected bit rate typical.

### **2.3.15 User-Defined Messages**

- Number of Programmable Messages: • Three (USER 1, USER 2, USER 3).
- Message Length: • 2048 characters.
- Entry Format: • One hexadecimal character pair per transmitted character.
- Output Format (Async): • 5, 6, 7, or 8 level code.

### **2.3.16 Front Panel Programs**

- Number of Front-Panel Programs: • 10.
- Functions Under User Program Control: • Front panel switch settings, keypad entries, auxiliary functions, etc.
- Access: • Program entry and program recall via the RECALL/STORE function of the **MENU** switch.

### **2.3.17 Non-Volatile Memory**

- Information Stored: • Current front panel switch settings, keypad entries, auxiliary functions.
  - Three user-defined messages.
  - 10 front-panel programs.
  - Time and date of last power-down.
  - Results from before power-down.
- Memory Back-up Battery Life: • Typically greater than 7 years.



**2.3.18 Remote Control Capability**

- Remote Control Access:
- RS-232 Printer/Remote Control Interface.
  - Optional IEEE-488 Interface.
- Controllable Functions:
- Front panel switch settings.
  - Keypad entries.
  - Auxiliary functions.
  - User-defined messages.

**2.3.19 Internal RS232 Data Interface**

- Connectors:
- Two 25-pin D subminiature female connectors.
  - One connector for DTE emulation labeled TO DCE.
  - One connector for DCE emulation labeled TO DTE.
- Signal Format:
- Bipolar, unbalanced.
- Data Bit Rates:
- Asynchronous - 50 to 20,000 b/s per EIA RS-232 and CCITT V.28.
  - Synchronous - 50 b/s to 64 kb/s.

**2.3.20 External Data Interface**

- External Data Interface Slot:
- Accepts any FIREBERD data interface.

**2.3.21 Rear Panel Test Points**

- Output Test Points:
- Generator Clock.
  - Generator Data.
  - Generator Pattern Sync.
  - Receiver Clock.
  - Receiver Data.
  - Receiver Pattern Sync.
  - Error.
  - Sync.
  - Test Point Z.
  - Signal Ground.
- Logic Low Output:
- 0.4 volts maximum at 12 mA or less.
- Logic High Output:
- 2.4 volts minimum at 3 mA or less.
- Input Test Points:
- External Delay Start.
  - External Delay Stop.
- Logic Low Input:
- 0.8 volts maximum.
- Logic High Input:
- 2.0 volts minimum.
- Input Impedance:
- 2000 ohms minimum.

## ***Instrument Description***

### **2.3.22 Real Time Clock**

- Display Clock Functions:
- Hours (24-hour format).
  - Minutes.
  - Seconds.
  - Month.
  - Day.
  - Year.
- Printed Clock Functions:
- Hours.
  - Minutes.
  - Seconds.
  - Month.
  - Day.
  - Year.
- Accuracy:
- Typically better than 1 second per day.

### **2.3.23 Display**

- Display Type:
- Vacuum Fluorescent Display.
- Display Size:
- 80 characters — 40 characters x 2 lines.
- Character Font:
- 5 x 7 dot matrix and cursor.

### **2.3.24 Audio Output**

- Audio Indicator:
- Speaker.
- Audio Level Control:
- Volume control — off, minimum to maximum.

### **2.3.25 Power Requirements**

- Voltage:
- Two user selectable ranges: 90-135 VAC, 195-250 VAC.
- Frequency:
- 48 to 66 Hz.
- Power:
- 110 volt-amperes maximum.

### **2.3.26 Environmental Specifications**

- Operating Temperature Range:
- 0° C (+32° F) to +50° C (124° F).
- Storage Temperature Range:
- -30° C (-22° F) to +75° C (167° F).

### 2.3.27 Dimensions and Weight

#### FIREBERD 6000

- Size: • 6" H x 12" W x 12" D.  
 Weight: • 15.8 lbs with all options, a data interface, and the IEEE-488 Remote Control Interface installed.

#### FIREBERD MC6000

- Size: • 6.5" H x 14.5" W x 14" D.  
 Weight: • 19.3 lbs with all options, a data interface, and the IEEE-488 Remote Control Interface installed.

#### FIREBERD 6000R

- Size: • 6" H x 12" W x 12" D.  
 Weight: • 12.0 lbs with all options, a data interface, and the IEEE-488 Remote Control Interface installed.

## 2.4 FRONT PANEL SWITCHES AND INDICATORS

This section describes the FIREBERD 6000 front panel switches and indicators in alphabetical order. Figure 2-1 provides a visual reference for the switch and indicator locations. The following list indicates where the switch and/or indicator description can be found.

<u>SWITCH/INDICATOR:</u>	<u>DESCRIBED ON PAGE:</u>
ALM1 and ALM2	2-12
<b>ANALYSIS MODE</b>	2-13
ANALYSIS RESULTS	2-14
AUX FUNC IN USE	2-28
CLK INV	2-29
CODE	2-30
CTS	2-31
DATA	2-32
DATA INV	2-37
DISPLAY HOLD	2-38
DSR (DM) LED INDICATOR	2-39
<b>DSR (DM) SWITCH</b>	2-40
DTR LED INDICATOR	2-41
<b>DTR SWITCH</b>	2-42
EMULATE DCE	2-43
EMULATE DTE	2-44
<b>ERROR INSERT</b>	2-45
FRM SYNC	2-46
<b>GEN CLK</b>	2-47
Keypad	2-54
(LL)	2-48
<b>LOOP DOWN</b>	2-49
<b>LOOP UP</b>	2-50
<b>MENU</b>	2-51
SYNTH FREQ	2-56
INTF SETUP	2-57
TEST INTERVAL	2-58

## *Instrument Description*

### SWITCH/INDICATOR:

### DESCRIBED ON PAGE:

CHAR FORMAT	2-59
JITTER	2-60
PRINT EVENT	2-61
RECALL/STORE	2-63
AUXILIARY	2-64
MK	2-72
NO CLK	2-73
<b>POWER</b>	2-74
PRINTER	2-75
<b>RESTART</b>	2-76
(RL)	2-77
RLSD (RR) LED INDICATOR	2-78
<b>RLSD (RR) SWITCH</b>	2-79
RTS LED INDICATOR	2-80
<b>RTS SWITCH</b>	2-81
<b>SELF LOOP</b>	2-82
SP	2-83
SYNC	2-84
<b>SYNC LOST</b>	2-87
<b>TIMING MODE</b>	2-89
(TM)	2-92
<b>VOLUME</b>	2-93

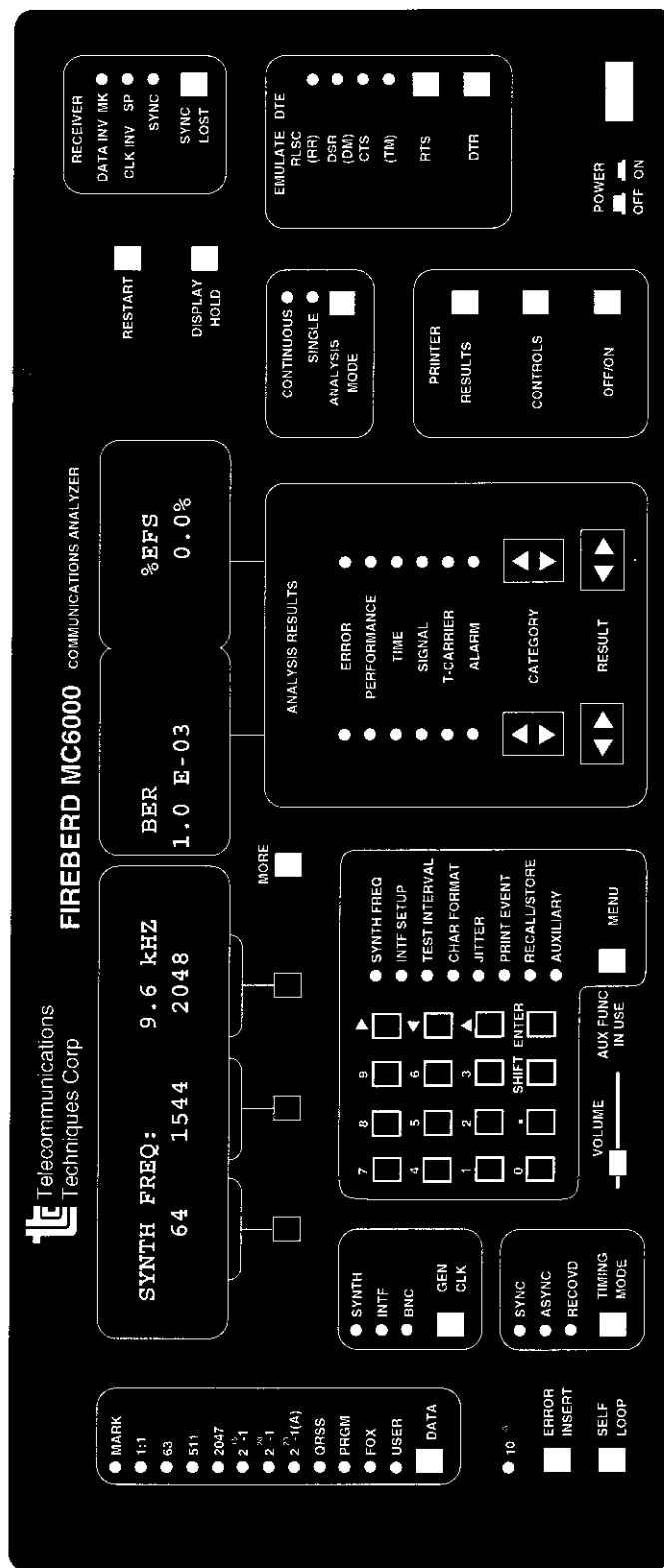
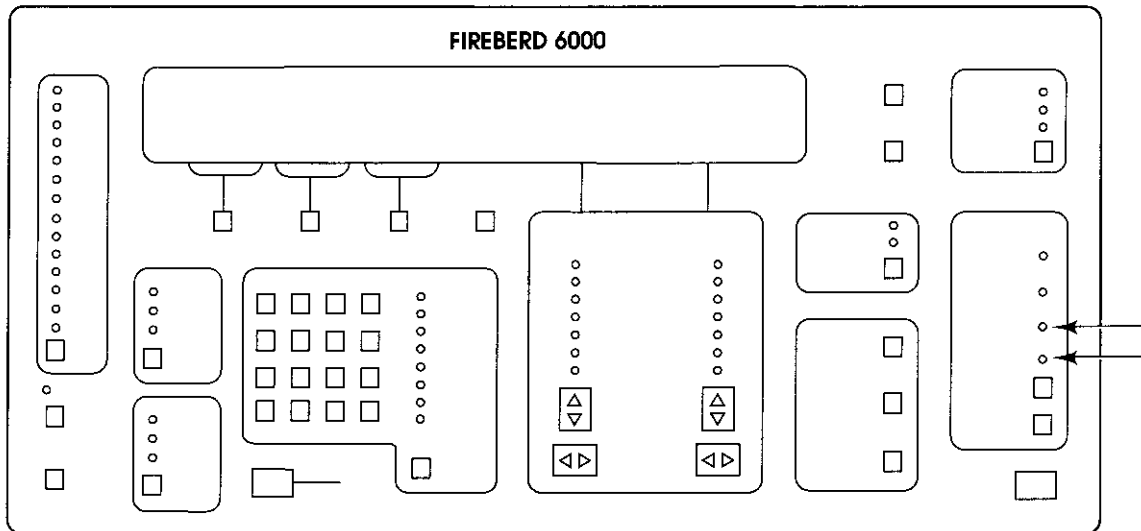

Figure 2-1  
FIREBERD 6000 Front Panel Switches and Indicators

Interface-Specific Alarm Conditions



Front-Panel Component-Type:

Discrete LED indicators with adjacent labels.

Purpose:

The ALM1 and ALM2 LEDs illuminate to indicate the presence of an interface-specific alarm condition. When illuminated, check the interface operating manual associated with the currently selected interface for the specific cause of the alarm.

ANALYSIS MODE

ANALYSIS MODE

## Run a Single Test or a Continuous Test

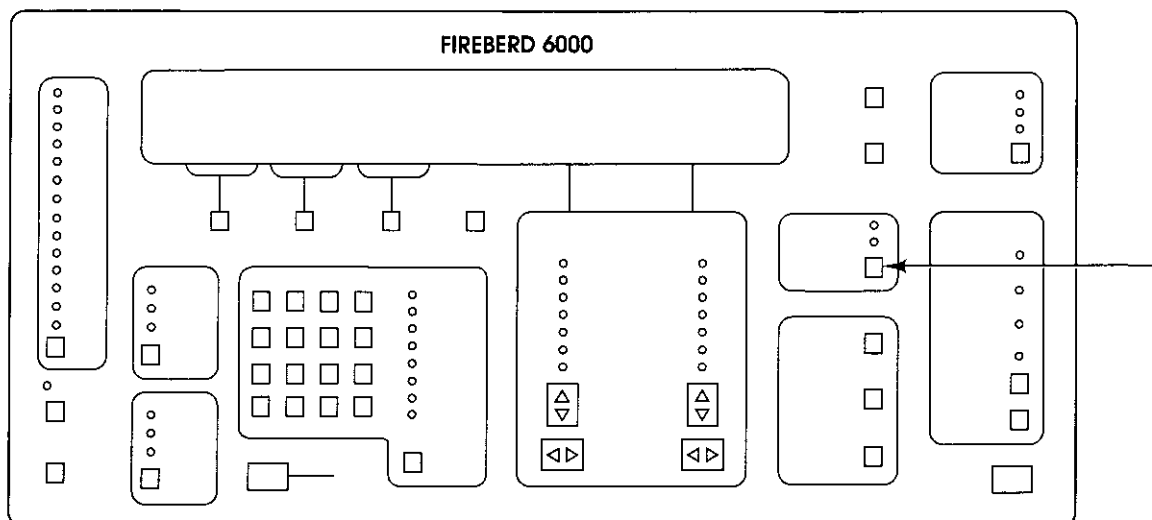
**Front-Panel Component-Type:**

Multifunction switch.

**Purpose:**The **ANALYSIS MODE** switch determines whether a test is run continuously or for a selected interval.

Select:	To:
CONTINUOUS	Run a test continuously and indefinitely accumulate test results.
SINGLE	Run a test and accumulate test results for a specified test interval only.

**Notes:**

1. In SINGLE mode, the actual length of the test is determined by the TEST INTERVAL function of the MENU switch. TEST INTERVAL category selections are: 10<sup>4</sup>, 10<sup>5</sup>, 10<sup>6</sup>, 10<sup>7</sup>, 10<sup>8</sup>, 10<sup>9</sup>, 10<sup>10</sup>, or TIMED. Selecting a value (10<sup>4</sup> to 10<sup>10</sup>) specifies the number of bits counted for the test interval. Selecting TIMED allows a time interval, up to 24 hours, to be specified as the test interval.
2. In SINGLE mode, transmission continues even though test time has expired. However, no analysis is performed.

ANALYSIS RESULTS

Display Test Results

ANALYSIS RESULTS

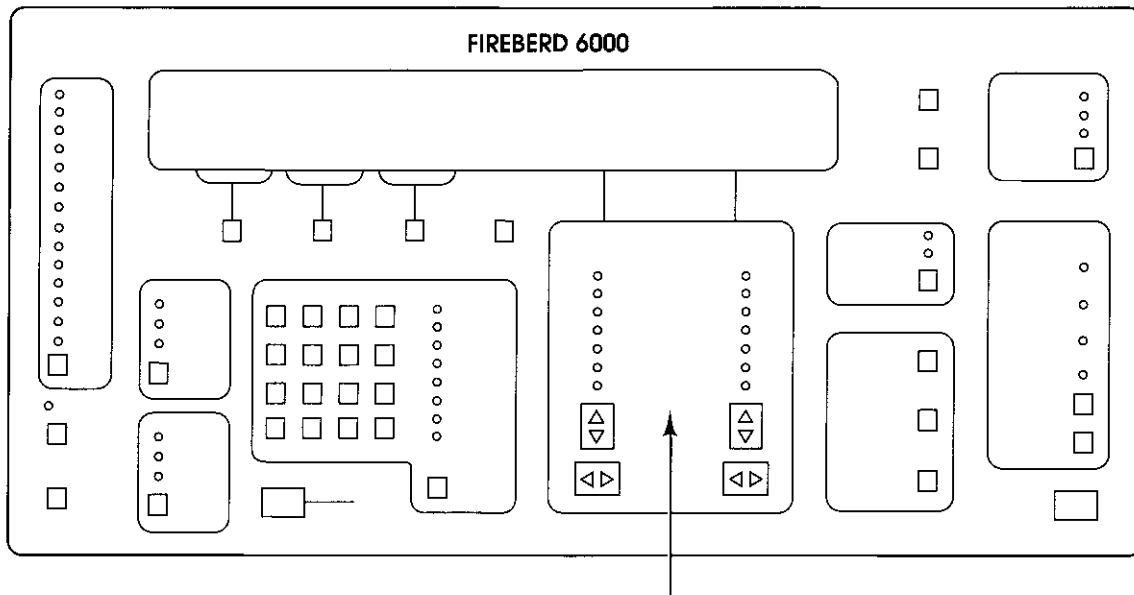

Front-Panel Component-Type:

CATEGORY: Rocker switch.

RESULT: Rocker switch.

Purpose:

The two sets of two **ANALYSIS RESULTS** switches control the display of test results. The left and right **CATEGORY** switches are used to select an analysis category. The left and right **RESULT** switches are used to scroll and display a specific analysis result from the selected category.

Two **CATEGORY** and **RESULT** switches are available to permit any two of the following test results to be displayed simultaneously. Since many of these results are interface- and mode-specific, not all of them appear when running a given test.

USE THE CATEGORY SWITCH TO SELECT:

ERROR

USE THE RESULT SWITCH TO DISPLAY:

- ABRT FRM (Aborted Frames)
- AVG BER (Average Bit Error Rate)
- AVG BLER (Average Block Error Rate)
- AVG FRM (Average Frame Size)
- BE CN FRM (Backward Explicit Congestion Notification Frame)
- BER (Bit Error Rate)
- BIT ERRS (Bit Errors)
- BLK ERRS (Block Errors)
- BLOCKS (Blocks)
- CHAR ERR (Asynchronous Character Errors)
- DE FRM (Discard Eligibility Frame)
- ECHO PNG (Echoed PING Packets)
- ERR FRM (Errored Frame)
- FCS ERRS (FCS Errors)
- FECN FRM (Forward Explicit Congestion Notification Frame)



## ANALYSIS RESULTS

## ANALYSIS RESULTS

**Display Test Results  
(Continued)**

**USE THE CATEGORY  
SWITCH TO SELECT:**

**USE THE RESULT SWITCH TO DISPLAY:**

## ERROR

FRM CNT (Frame Count)  
 FRM OCTS (Frame Octets)  
 FRM RATE (Frame Rate)  
 LMI ERRS (Local Management Interface Errors)  
 LMI MSGS (Local Management Interface Messages)  
 LMI TMOS (Local Management Interface Timeouts)  
 LOST FRM (Lost Frames)  
 LOST PING (Lost PING Packets)  
 PAT SLIP (Pattern Slips)  
 PVC STAT (Permanent Virtual Circuit Status)  
 SHRT FRM (Short Frames)  
 TX PING (Transmitted PING Packets)

## PERFORMANCE

%AVL SEC (Percent Available Seconds)  
 %DEG MIN (Percent Degraded Minutes)  
 %SES (Percent Severely Errored Seconds)  
 %SVS (Percent Severely Violated Seconds)  
 AVG PING (Average PING Delay)  
 AVG TPUT (Average Throughput)  
 AVG%UTIL (Average Percent Utilization)  
 AVL SEC (Available Seconds)  
 BER-SES (Bit Error Rate Over Non-Severely Errored Seconds)  
 DEG MIN (Degraded Minutes)  
 ERR-SES (Bit Errors Over Non-Severely Errored Seconds)  
 G %EFS (G.821 Percent Error-Free Seconds)  
 G %VFS (G.821 Percent Violation-Free Seconds)  
 G EFS (G.821 Error-Free Seconds)  
 G ERR SEC (G.821 Errored Seconds)  
 G VFS ( G.821 Violation-Free Seconds)  
 MAX PING (Maximum PING Delay)  
 MAX TPUT (Maximum Throughput)  
 MAX%UTIL (Maximum Percent Utilization)  
 MIN PING (Minimum PING Delay)  
 SES (Severely Errored Seconds)  
 SVS (Severely Violated Seconds)  
 UNA SEC (Unavailable Seconds)

## TIME

%ACT SEC (Percent Active Seconds)  
 %PAT SEC (Percent Synchronized Seconds)  
 BPV % EFS (Bipolar Violation Percent Error Free Seconds)  
 BPV SEC (Bipolar Violation Seconds)  
 CPE S A (C-bit Parity Errored Seconds [Type A])  
 CPE S B (C-bit Parity Errored Seconds [Type B])  
 CPE S C (C-bit Parity Errored Seconds [Type C])

ANALYSIS RESULTS

ANALYSIS RESULTS

Display Test Results  
(Continued)

USE THE CATEGORY  
SWITCH TO SELECT:

USE THE RESULT SWITCH TO DISPLAY:

TIME

DATE (Date)  
E A SEC (Error Analysis Seconds)  
E F EAS (Error-Free Error Analysis Seconds)  
ELAP SEC (Elapsed Seconds)  
ERR EAS (Errored Error Analysis Seconds)  
FEBE S A (Far End Block Errored Seconds [Type A])  
FEBE S B (Far End Block Errored Seconds [Type B])  
FEBE S C (Far End Block Errored Seconds [Type C])  
PATL SEC (Pattern Sync Loss Seconds)  
SIGL SEC (Signal Loss Seconds)  
TIME (Time)

SIGNAL

%MASK (Maximum Percent of Jitter Mask)  
+LVL dB (Positive Level in Decibels)  
+LVL V (Positive Level in Volts)  
+WNDR (Positive Peak-to-Peak Wander)  
-LVL dB (Negative Level in Decibels)  
-LVL V (Negative Level in Volts)  
-WNDR (Negative Peak-to-Peak Wander)  
1SEC JTR (One-Second Jitter)  
15m WNDR (15-Minute Wander)  
24h WNDR (24-Hour Wander)  
DAT RATE (Data Rate)  
DATA TEI (Data Terminal Endpoint Identifier)  
DELAY (Delay)  
GEN FREQ (Generator Clock Frequency)  
JTR HITS (Jitter Hits)  
LVL dBm (Power Level of All-Ones Signal in dBm)  
MAX JTR (Maximum Jitter)  
PP LVL V (Peak-to-Peak Level in Volts)  
PP WNDR (Peak-to-Peak Wander)  
PWR STAT (ISDN Power Feeding Status)  
R LVL-dB (Receiver Signal Level in Decibels)  
R LVL-V (Receiver Signal Level in Volts)  
RCV BYTE (Receive Byte)  
RCV CODE (Receive Code)  
RCV FREQ (Receiver Clock Frequency)  
RT DELAY (Round Trip Delay)  
RX INFO (Receiver Information Sequence State)  
S/A FREQ (Spectrum Analyzer Frequency)  
SMPX CUR (Simplex Current)  
TEI (Terminal Equipment Identifier Assigned)  
TX INFO (Transmitter Information Sequence State)  
VOICE TEI (Voice Terminal Endpoint Identifier)

## ANALYSIS RESULTS

## ANALYSIS RESULTS

**Display Test Results  
(Continued)**

**USE THE CATEGORY  
SWITCH TO SELECT:**

T-CARRIER

**USE THE RESULT SWITCH TO DISPLAY:**

%VF EAS (% Violation-Free Error Analysis Seconds)  
 1SEC CRC (One-Second CRC Errors)  
 AVG BPVR (Average Bipolar Violation Rate)  
 AVG CER (Average Code Error Ratio)  
 AVG CPER (Average C-bit Parity Error Rate)  
 AVG CRC (Average CRC Errors)  
 AVG FAS (Average Frame Alignment Signal Error Rate)  
 AVG FEBE (Average Far End Block Error Rate)  
 AVG FER (Average Frame Error Rate)  
 AVG MFAS (Average Multiframe Alignment Signal Error Rate)  
 AVG PER (Average Parity Error Rate)  
 AVG REBE (Average Remote End Block Errors)  
 BIT SLIP (Bit Slips)  
 BPV RATE (Bipolar Violation Rate)  
 BPVs (Bipolar Violations)  
 CER (Code Error Ratio)  
 CODE ERR (Code Errors)  
 CP E Rt (C-bit Parity Error Rate)  
 CPAR ERR (C-bit Parity Errors)  
 CRC E Rt (CRC Error Rate)  
 CRC ERR (CRC Errors)  
 F BPV S (Far End BPV Seconds)  
 F CRC E (Far End CRC Errored Events)  
 F F SES (Far End Severely Errored Framing Seconds)  
 F FR ES (Far End Frame Error Seconds)  
 F HI CRC (Far End High CRC Error Seconds)  
 F HS CRC (Far End High and Severe CRC Error Seconds)  
 F LO CRC (Far End Low CRC Error Seconds)  
 F M CRC (Far End Medium CRC Error Seconds)  
 F MH CRC (Far End Medium-High CRC Error Seconds)  
 F SI CRC (Far End Single CRC Error Seconds)  
 F SLP S (Far End Controlled Slip Seconds)  
 F SV CRC (Far End Severely Errored CRC Seconds)  
 FAS E Rate (Frame Alignment Signal Error Rate)  
 FAS ERR (Frame Alignment Signal Error)  
 FCS ERR (Frame Check Sequence Errors)  
 FE RATE (Frame Error Rate)  
 FEBE (Far End Block Errors)  
 FEBE Rt (Far End Block Error Rate)  
 FRA ERR (Frame Errors)  
 FRA LOSS (Frame Synchronization Loss)  
 FRMR (Frame Reject Frames)  
 L2 ABORT (Layer 2 Aborts)  
 L2 F ERR (Layer 2 Frame Errors)  
 L2 FRMS (Number of Layer 2 Frames)  
 MAX ZERO (Maximum Consecutive Zeros)  
 MFAS ERR (Multiframe Alignment Signal Word Errors)  
 PAR ERR (Parity Errors)

ANALYSIS RESULTS

ANALYSIS RESULTS

Display Test Results  
(Continued)

USE THE CATEGORY  
SWITCH TO SELECT:

USE THE RESULT SWITCH TO DISPLAY:

T-CARRIER

PARE Rt (Parity Error Rate)  
PAY SRC (Payload Source and Loopback Status)  
PRM TIM (Performance Report Message Time)  
RCV BOM (Received Bit-Oriented Message)  
RCV FAS (Received Frame Alignment Signal Word)  
RCV FEAC (Received FEAC Code)  
RCV MFAS (Received Multiframe Alignment Signal Word)  
RCV NFAS (Received Not Frame Alignment Signal Word)  
REBE (Remote End Block Errors)  
REBE Rt (Remote End Block Error Rate)  
REJ FRM (Reject Frames)  
RX ABCD (DS0 ABCD Signal)  
RX X1 X2 (Received X Bits)  
VF EAS (Violation-Free Error Analysis Seconds)

ALARM

1s DEN S (Ones Density Violation Seconds)  
AIS SEC (Alarm Indication Signal Seconds)  
C-D CHA (Clock-Data Phase Change)  
CLK LOSS (Receiver Clock Loss Count)  
DAT LOSS (Receiver Data Loss Count)  
FASDIS S (Frame Alignment Signal Distant Alarm Seconds)  
FEEOF S (Far End Out-Of-Frame Seconds)  
MF DIS S (Multiframe Alignment Signal Distant Alarm Seconds)  
NEEOF S (Near End Out-Of-Frame Seconds)  
PAT LOSS (Pattern Synchronization Loss Count)  
PWR LOSS (Power Loss)  
REM SEC (Remote Alarm Seconds)  
SIG LOSS (Receiver Signal Loss)  
T16 AIS S (Timeslot 16 Alarm Indication Signal Seconds)  
V FR SEC (Violated Frame Seconds)  
XS0 SEC (Excess Zero Seconds)  
YEL SEC (Yellow Alarm Seconds)

Notes:

1. Certain results associated with the T-CARRIER analysis category do not necessarily apply to T1, T1C, T2, or T3 testing. Many results are specific to a single interface, as follows:

**Interface:**

ISDN S/T Interface  
(Model 41075)

**Result:**

Layer 2 Frame Errors  
Frame Check Sequence Errors  
Layer 2 Frames  
Layer 2 Frame Aborts  
Rejection Frames  
Frame Rejection Frames

## ANALYSIS RESULTS

## ANALYSIS RESULTS

Display Test Results  
(Continued)

<u>Interface:</u>	<u>Result:</u>
G.704 2048 kb/s Framing Interface (Model 30609)	Code Errors Code Error Rate Frame Alignment Signal (FAS) Errors Frame Alignment Signal Error Rate Average Frame Alignment Signal Error Rate
2M/n64 Interface (Model 41800)	Code Errors Code Error Rate Frame Alignment Signal (FAS) Errors Frame Alignment Signal Error Rate Average Frame Alignment Signal Error Rate Multiframe Alignment Signal Word Errors Average Multiframe Alignment Signal Error Rate Received Frame Alignment Signal Word Received Not Frame Alignment Signal Word Received Multiframe Alignment Signal Word Timeslot 16 Alarm Indication Signal Seconds Frame Alignment Signal Distant Alarm Seconds Multiframe Alignment Signal Distant Alarm Seconds

- The left and right **CATEGORY** and **RESULT** switch operation is identical (i.e., both sides work the same way and offer the same analysis categories and results).
- All test results are listed and described in the following list.

The FIREBERD 6000 offers a range of test results in various categories. Since many of these results are interface- and mode-specific, not all of them will necessarily appear when running a given test.

**ANALYSIS RESULTS CATEGORIES****ERROR Category**

In standard test mode, the received data is analyzed for bit errors, pattern slips, and refined error results immediately upon synchronizing to a known data pattern.

**Aborted Frames (ABRT FRM)** - A count of the aborted Frame relay frames detected (excluding out of frame aborts). This result is calculated across all DLCIs. The number of aborted frames indicates that the frame has become all 1's and that the link is dead or the switch on the other end stopped a frame in the middle of its transmission.

**Average Bit Error Rate (AVG BER)** - The ratio of the number of bit errors counted to the number of data bits examined since the beginning of the test.

**Average Block Error Rate (AVG BLER)** - The ratio of the number of block errors counted to the number of blocks examined since the beginning of the test.

**ANALYSIS RESULTS**

**ANALYSIS RESULTS**

**Display Test Results  
(Continued)**

**Average Frame Size (AVG FRM)** - The average frame size calculated as the number of FRM OCTS divided by the FRM CNT number. This result can be calculated across all DLCIs or for one specific DLCI.

**Backward Explicit Congestion Notification Frame (BECN FRM)** - A count of valid frames with the BECN bit set (e.g., 1). This result can be calculated across all DLCIs or for one specific DLCI. This result incrementing indicates that the network is detecting congestion along the PVC because the far end DLCI is sending data too fast. Reducing the volume or rate of transmission is recommended.

**Bit Error Rate (BER)** - The ratio of the number of bit errors counted over the last test interval to the number of data bits examined in the last test interval.

**Bit Errors (BIT ERRS)** - The number of errored data bits counted since the beginning of the test.

**Block Errors (BLK ERRS)** - The number of complete blocks received since the beginning of the test that contain one or more bit errors.

**Blocks (BLOCKS)** - The number of complete blocks received since the beginning of the test. The length of a block is set through auxiliary function 30.

**Character Errors (CHAR ERR)** - In asynchronous timing, the number of characters received since the beginning of the test that contain one or more data errors.

**Discard Eligibility Frame (DE FRM)** - A count of valid frames with the DE bit set (e.g., 1). This result can be calculated across all DLCIs or for one specific DLCI. This result increments to indicate that frames being received have been designated as being discard eligible.

**Echoed PING Packets (ECHO PNG)** - Number of successful echo replies transmitted by the FIREBERD 6000. The destination address within the arriving ping packet must match the source address of the unit transmitting the echo reply. The destination address of the unit transmitting an echo reply can be blank or incorrect, it is irrelevant. When the 12 FRAME RELAY auxiliary function is enabled, the result is incremented in any mode.

**Errored Frame (ERR FRM)** - A count of the invalid Frame relay frames detected (this count includes errored, short, and aborted frames). This result is calculated across all DLCIs. The number of errored frames incrementing indicates that there is a Physical Layer impairment between the FIREBERD and the network switch.

**FCS Errors (FCS ERRS)** - A count of the invalid frame relay frames received with FCS errors. This result is calculated across all DLCIs. The number of errored frames incrementing indicates that there is a Physical Layer impairment on the monitored link.

**Forward Error Congestion Notification Frame (FECN FRM)** - A count of valid frames with the FECN bit set (e.g., 1). This result can be calculated across all DLCIs or for one specific DLCI. This result incrementing indicates that the network is detecting congestion along the PVC at the receiving DLCI. Reducing the volume or rate of transmission is recommended.

**Frame Count (FRM CNT)** - A count of the total number of frame relay frames detected (including errored and aborted frames). This result can be calculated across all DLCIs or for one specific DLCI.

**Frame Octets (FRM OCTS)** - A count of the total number of octets received in valid frame relay frames. This result can be calculated across all DLCIs or for one specific DLCI.

**Frame Rate (FRM RATE)** - The average number of frames received since the start of the test.

## ANALYSIS RESULTS

## ANALYSIS RESULTS

**Display Test Results  
(Continued)**

**Local Management Interface Errors (LMI ERRS)** - The total number of LMI errors detected. LMI errors indicate that the receive sequence number is not equal to the last transmitted send sequence number. This result incrementing indicates that the link from your FIREBERD to the network switch is down.

**Local Management Interface Messages (LMI MSGS)** - The total number of LMI messages received back from the switch since the start of the test. An incrementing count for this result indicates a "heartbeat".

**Local Management Interface Timeouts (LMI TMOS)** - The number of LMI timeouts. Indicates nonreceipt of a STATUS message within a polling interval after a STATUS ENQUIRY has been sent. This result incrementing indicates that the link from your FIREBERD to the network switch is down, that the link from the switch to you is down, or that the switch is down.

**Lost Frame (LOST FRM)** - A count of TTC test frames that appear to have been lost by the network, based on gaps in the test frame's sequence number. This result can only be calculated for one specific DLCI. This result increments to indicate that frames are being dropped from the network. Frames are dropped from the network when the frame is errored (has an invalid FCS) or is discarded because the DE bit is set.

**Lost PING Packets (LOST PNG)** - Number of ping packets that were not echoed back to the FIREBERD 6000; including out of order echo reply packets and corrupted echo reply packets. The result is not used in delay calculations. The result increments only when the transmit frame load is set to PING.

**Pattern Slips (PAT SLIP)** - The number of occurrences since the beginning of the test where data bits have been added to or deleted from the received pattern.

**Permanent Virtual Circuit Status (PVC STAT)** - The current status of the selected DLCI. This can be either ACTIVE or INACTIVE. This result is only available when one specific DLCI is being analyzed. This is the status that the switch is reporting.

**Short Frame (SHRT FRM)** - A count of the valid frames that are less than 5 bytes long, excluding the opening flag. This result is calculated across all DLCIs. The number of short frames incrementing indicates that a switch is bad or a piece of equipment is broken.

**Transmitted PING Packets (TX PING)** - Number of ping packets/frames transmitted by the FIREBERD 6000. The result increments only when the transmit frame load is set to PING.

### **PERFORMANCE Category**

CCITT Recommendation G.821-compatible performance results provide statistical information about the performance of the equipment or system under test. These results are derived by observing the received bit error counts and received bit counts at 1-second intervals, and classifying these seconds as available, unavailable, severely errored, or error-free. This division of test time is illustrated in Figure 2-2. Other calculations yield the number and percentage of degraded minutes, and percentages of available, severely errored, and error-free seconds.

In live analysis mode, the received BPV count and rate are used to classify each 1-second interval, and signal presence replaces pattern synchronization for performance analysis purposes.

**% Degraded Minutes (%DEG MIN)** - The ratio of the number of degraded minutes to the number of minutes derived from available, non-severely errored seconds, expressed as a percentage.

**% Severely Violated Seconds (%SVS)** - The ratio of the number of severely violated seconds to the number of available seconds, expressed as a percentage.

**% Available Seconds (%AVL SEC)** - The ratio of the number of available seconds to the number of test seconds since initial pattern synchronization, expressed as a percentage.

Display Test Results  
(Continued)

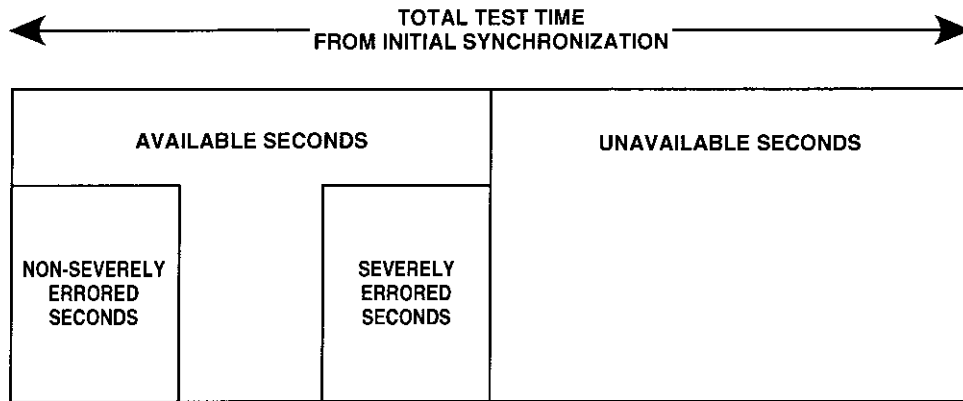

Figure 2-2  
Division of Test Seconds for Performance Analysis

**%Severely Errored Seconds (%SES)** - The ratio of the number of severely errored seconds to the number of available seconds, expressed as a percentage.

**Available Seconds (AVL SEC)** - The number of seconds judged available by CCITT criteria (see Appendix C).

**Average PING Delay (AVG PING)** - Average round trip delay, in milliseconds, since the beginning of the test based on the time difference between a transmitted ping and a successfully received echo reply. Resolution is 100  $\mu$ s. The result is only updated when the transmit frame load is set to PING.

**Average Percent Utilization (AVG%UTIL)** - The average percentage of link utilization on the received channel since the start of the test calculated as the number of FRM OCTS divided by the total number of octets received. This result can be calculated across all DLCIs or for one specific DLCI.

**Average Throughput (AVG TPUT)** - The average received throughput since the start of the test, calculated as total received UDF bits divided by the total seconds. This result can be calculated across all DLCIs or for one specific DLCI. This result can be used to estimate the CIR (committed information rate).

**Bit Errors Over Non-Severely Errored Seconds (BER-SES)** - The bit error rate, excluding the errors that occurred during severely errored seconds.

**Bit Errors Over Non-Severely Errored Seconds (ERR-SES)** - The total number of bit errors, excluding the errors that occurred during severely errored seconds.

**Degraded Minutes (DEG MIN)** - The number of blocks of 60 non-severely errored, available seconds in which the average BER was worse than  $10^{-6}$  (see Appendix B). Note that CCITT Recommendation G.821 eases this requirement at 64 kHz; when the average BER over 60 seconds is 64 kHz, and four bit errors are counted, the minute is not considered to be degraded.

**G.821 % Error-Free Seconds (G %EFS)** - The ratio of the number of available seconds in which no errors were detected to the total number of available seconds, expressed as a percentage.

**G.821 %Violation-Free Seconds (G %VFS)** - The ratio of the number of available seconds in which BPVs were not detected to the total number of available seconds, expressed as a percentage.

**G.821 Error-Free Seconds (G EFS)** - The number of available seconds in which no bit errors occurred.

**G.821 Errored Seconds (GERR SEC)** - The number of available seconds in which at least one bit error occurred.



## ANALYSIS RESULTS

## ANALYSIS RESULTS

**Display Test Results  
(Continued)**

**G.821 Violation-Free Seconds (G VFS)** - The number of available seconds in which BPVs were not detected.

**Maximum PING Delay (MAX PING)** - Maximum round trip delay, in milliseconds, since the beginning of the test based on the time difference between a transmitted ping and a successfully received echo reply. Resolution is 100  $\mu$ s. The result is only updated when the transmit frame load is set to PING.

**Maximum Percent Utilization (MAX%UTIL)** - The maximum percentage of link utilization on the received channel in any one second since the start of the test. This result can be calculated across all DLCIs or for one specific DLCI.

**Maximum Throughput (MAX TPUT)** - The maximum received throughput during any one second since the start of the test. This result can be calculated across all DLCIs or for one specific DLCI.

**Minimum PING Delay (MIN PING)** - Minimum round trip delay, in milliseconds, since the beginning of the test based on the time difference between a transmitted ping and a successfully received echo reply. Resolution is 100  $\mu$ s. The result is only updated when the transmit frame load is set to PING.

**Severely Errored Seconds (SES)** - The number of available seconds during which the BER is higher than  $10^{-3}$ .

**Severely Violated Seconds (SVS)** - The number of available seconds during which the BPV rate was higher than  $10^{-3}$ .

**Unavailable Seconds (UNA SEC)** - The number of seconds judged unavailable by CCITT criteria (see Appendix C).

### TIME Category

The TIME category offers a variety of time-based results.

**% Active Seconds (%ACT SEC)** - The ratio of the number of seconds during which a signal was present (active) for the entire second to the total number of seconds since initial signal presence, expressed as a percentage.

**%Pattern Sync Seconds (%PAT SEC)** - The ratio of the number of seconds in which pattern synchronization was achieved with no synchronization losses to the total number of seconds since initial pattern synchronization, expressed as a percentage.

**Bipolar Violation % Error-Free Seconds (BPV SEC)** - The ratio of the number of error analysis seconds during which no bipolar violations were detected to the number of seconds, expressed as a percentage.

**Bipolar Violation Seconds (BPV SEC)** - The number of error analysis seconds during which bipolar violations were detected.

**C-bit Parity Errors Type A (CPE S A)** - The number of error analysis seconds during which one C-bit parity error was detected. This result only appears when C-bit framing is selected.

**C-bit Parity Errors Type B (CPE S B)** - The number of error analysis seconds during which 2 to 44 C-bit parity errors were detected. This result only appears when C-bit framing is selected.

**C-bit Parity Errors Type C (CPE S C)** - The number of error analysis seconds during which more than 44 C-bit parity errors were detected. This result only appears when C-bit framing is selected.

**Calendar Date (DATE)** - The calendar date in day, month, and year. The current date is set using auxiliary function 60.

**Elapsed Seconds (ELAP SEC)** - The number of seconds, based on the time-of-day clock, since the last major switch change or test restart.

**ANALYSIS RESULTS**

**Display Test Results  
(Continued)**

**ANALYSIS RESULTS**

**Error Analysis Seconds (EA SEC)** - The amount of time during which error analysis has been performed, expressed in seconds. The time that error analysis is performed depends on receiver pattern synchronization and the setting of auxiliary function 03 (Receiver Action Upon Sync Loss).

**Error-Free Error Analysis Seconds (EF EAS)** - The number of error analysis seconds during which no bit errors were detected.

**Errored Error Analysis Seconds (ERR EAS)** - The number of error analysis seconds during which one or more bit errors were detected. Errored error analysis seconds are asynchronous.

**Far End Block Error (FEBE S A)** - The number of error analysis seconds during which one FEBE was detected. This result only appears when C-bit framing is selected.

**Far End Block Error (FEBE S B)** - The number of error analysis seconds during which 2 to 44 FEBEs were detected. This result only appears when C-bit framing is selected.

**Far End Block Error (FEBE S C)** - The number of error analysis seconds during which more than 44 FEBEs were detected. This result only appears when C-bit framing is selected.

**Pattern Sync Loss Seconds (PATL SEC)** - The number of seconds during which the receiver was not in continuous pattern synchronization.

**Signal Loss Seconds (SIGL SEC)** - The number of seconds during which the signal was not present for any part of the second.

**Time of Day (TIME)** - The time of day in hours, minutes, and seconds. Hours are displayed in a 24-hour format. The current time is set using auxiliary function 60.

**SIGNAL Category**

The SIGNAL category offers measurements such as receiver clock frequency or the delay between two events. Optional jitter results are also displayed in this category.

**% of Jitter Mask (%MASK)** - Each time the jitter spectrum analyzer takes a reading, the ratio of the measured jitter amplitude to the reference jitter mask's value is calculated. If the spectrum analyzer is sweeping, then the maximum value of that ratio since the beginning of the test is displayed as a percentage; a value of less than 100% indicates that no spectrum analyzer reading exceeded the reference mask during the test. If the spectrum analyzer is not sweeping, then the ratio of the last spectrum analyzer reading to the reference mask at that frequency is displayed as a percentage.

**1-Second Jitter (1SEC JTR)** - The maximum amount of timing jitter measured over the last 1-second test interval, expressed in UIs peak-to-peak.

**15-Minute Wander (15m WNDR)** - The maximum peak-to-peak wander deviation over the last 15 minutes of the test. This result is unavailable during the first 15 minutes of the test and is updated once per minute thereafter.

**24-Hour Wander (24h WNDR)** - The maximum peak-to-peak wander deviation over the last 24 hours of the test. This result is unavailable during the first 24 hours of the test and is updated once per hour thereafter.

**Data Rate (DAT RATE)** - In local loop testing, the received data rate of the primary or secondary channel being analyzed, expressed in b/s.

**Data Terminal Endpoint Identifier (DATA TEI)** - The value assigned by the network for the data circuit.

## ANALYSIS RESULTS

## ANALYSIS RESULTS

Display Test Results  
(Continued)

**Delay (DELAY)** - The most recently measured time interval between the start and finish of specific events. The start and stop events are selected using auxiliary function 31.

**Generator Frequency (GEN FREQ)** - The current measurement of the generator clock frequency.

**ISDN Power Feeding Status (PWR STAT)** - In ISDN testing, a check of the NT's power feeding status, displayed as a result.

**Jitter Hits (JTR HITS)** - A count of the number of times that jitter has exceeded the selected hits threshold since the beginning of the test.

**Maximum Jitter (MAX JTR)** - The largest value of 1-second jitter measured since the beginning of the test, expressed in Unit Intervals (UIs) peak-to-peak.

**Negative Receive Level in Decibels (-LVL dB)** - The level of the received signal in dB, relative to the negative level measurement. The range and resolution of this measurement are interface-dependent.

**Negative Receive Level in Volts (-LVL V)** - The level of the received signal in volts, measured on negative pulses. The range and resolution of this measurement are interface-dependent.

**Negative Wander (-WNDR)** - The maximum negative peak wander deviation since the beginning of the test, expressed in UIs.

**Peak-To-Peak Wander (PP WNDR)** - The total deviation of positive-to-negative peak wander since the beginning of the test, expressed in UIs.

**Peak-to-Peak Receive Level in Volts (PP LVL V)** - The level of the received signal in peak-to-peak volts. The range and resolution of this measurement are interface-dependent.

**Positive Receive Level in Decibels (+LVL dB)** - The level of the received signal in decibels, relative to the positive level measurement. The range and resolution of this measurement are interface-dependent.

**Positive Receive Level in Volts (+LVL V)** - The level of the received signal in volts, measured on the positive T1 pulses. The range and resolution of this measurement are interface-dependent.

**Positive Wander (+WNDR)** - The maximum positive peak wander deviation since the beginning of the test, expressed in UIs.

**Power Level of All-Ones Signal in dBm (LVL dBm)** - The power level of an unframed all-ones signal referenced to 1 milliwatt (available only when AIS is detected).

**Receive Byte (RCV BYTE)** - The received data bytes displayed in binary form.

**Receive Code (RCV CODE)** - When a T1 interface is selected, this result reflects the type of line coding received (e.g., B8ZS, AMI, etc.). When a DDS interface is selected, this result reflects the received bytes which are interpreted as special network codes; the name of the network code is displayed in abbreviated form.

**Receiver Frequency (RCV FREQ)** - The current measurement of the receiver clock frequency.

**Receiver Information State (RCV INFO)** - In ISDN testing, the specific sequence of line signals used to bring the TE and NT into synchronization.

**Receiver Signal Level in Volts (R LVL V)** - In ISDN and DDS Local Loop testing, a measurement of the receiver signal level in volts. The range and resolution of this measurement are interface-dependent.

**ANALYSIS RESULTS**

**ANALYSIS RESULTS**

**Display Test Results  
(Continued)**

**Receiver Signal Level Measurement in Decibels (R LVL dB)** - In ISDN and DDS Local Loop testing, a measurement of the receiver signal level in decibels. The range and resolution of this measurement are interface-dependent.

**Round trip Delay (RT DELAY)** - The current measurement, in milliseconds, of the round trip delay.

**Simplex Current in mA (SMPX CUR)** - The simplex current flowing between the transmit (output) tip and ring and the receive (input) tip and ring (interface dependent).

**Spectrum Analyzer Frequency (S/A nnn)** - The current spectrum analyzer frequency in Hertz or, if noted, kHz. Additionally, the measured jitter amplitude at the current frequency is displayed in unit intervals peak-to-peak. If the spectrum analyzer is sweeping, the amplitude is the largest measured at this frequency; if the spectrum analyzer is not sweeping, the amplitude is the last measured at this frequency.

**Terminal Equipment Identifier (TEI)** - When testing an AT&T ISDN switch, the actual TEI assigned.

**Transmitter Information State (TX INFO)** - In ISDN testing, the specific sequence of the line signals used to bring the NT and TE into synchronization.

**Voice Terminal Endpoint Identifier (VOICE TEI)** - The value assigned by the network for the voice circuit.

**T-CARRIER Category**

This category contains interface-specific analysis results.

**% Violation-Free Error Analysis Seconds (% V F EAS)** - The number of violation-free error analysis seconds to the number of error analysis seconds since the beginning of the test.

**Average BPV Rate (AVG BPVR)** - In T1 testing, the ratio of the number of BPVs detected to the number of data bits examined since the beginning of the test.

**Average C-bit Parity Error Rate (AVG CPER)** - The ratio of C-bit parity errors detected to the total number of parity bits received.

**Average Code Error Rate (AVG CER)** - In 2048 kb/s testing, the ratio of the number of code errors detected to the number of data bits examined since the beginning of the test.

**Average CRC Errors (AVG CRC)** - The ratio of the number of CRC errors detected to the number of CRCs examined since the beginning of the test.

**Average Far End Block Errors (AVG FEBE)** - The ratio of far end block errors to the total number of blocks received.

**Average FAS Error Rate (AVG FAS)** - In 2048 kb/s testing, the ratio of the number of FAS errors detected to the number of frame words examined since the beginning of the test.

**Average Frame Error Rate (AVG FER)** - The ratio of the number of frame errors detected to the number of framing bits examined since the beginning of the test.

**Average Multiframe Alignment Signal Error (AVG MFAS)** - The ratio of errored MFAS words to the total number of MFAS words detected.

**Average Remote End Block Errors (AVG REBE)** - The ratio of remote end block errors to the total number of blocks received.

## ANALYSIS RESULTS

## ANALYSIS RESULTS

**Display Test Results  
(Continued)**

**Bipolar Violations (BPVs)** - In T1 testing, the number of BPVs detected in the received signal.

**Bit Slips (BIT SLIP)** - In T1 testing, the number of bit slips in a frame, ranging from -32767 to +32767.

**BPV Rate (BPV Rate)** - In T1 testing, the ratio of the number of BPVs detected over the last test interval to the number of data bits examined.

**C-Bit Parity Errors (CPAR ERR)** - The number of C-bit parity errors detected since the test started.

**C-bit Parity Error Rate (CP E Rt)** - The number of C-bit parity errors detected to the number of parity bits received.

**Code Error Rate (CER)** - In 2048 kb/s testing, the ratio of the number of code errors detected over the last test interval to the number of data bits examined.

**Code Errors (CODE ERR)** - In 2048 kb/s testing, the number of code errors detected in the received signal.

**CRC Error Rate (CRC E Rt)** - The ratio of the number of CRC errors detected over the last test interval to the number of CRCs examined.

**CRC Errors (CRC ERR)** - The number of CRC errors detected since the beginning of the test.

**Far End BPV Seconds (F BPV S)** - The number of seconds with BPVs detected at the far end device.

**Far End Controlled Slip Seconds (F SLP S)** - The number of seconds in which a controlled slip was detected at the far end device.

**Far End CRC Errored Events (F CRC E)** - The minimum number of CRC errors detected at the far end device.

**Far End Block Error Rate (FEBE Rt)** - The rate at which far end block errors are detected at the far end device.

**Far End Block Errors (FEBE)** - The number of far end block errors detected at the far end device.

**Far End Frame Error Seconds (F FR ES)** - The number of seconds with one or more frame errors, but no frame losses detected at the far end device.

**Far End High CRC Error Seconds (F HI CRC)** - The number of seconds with at least 100 CRC errors but less than 319 CRC errors detected at the far end device.

**Far End High and Severe CRC Error Seconds (F HS CRC)** - The number of seconds with greater than 100 CRC errors detected at the far end device.

**Far End Low CRC Error Seconds (F LO CRC)** - The number of seconds with at least 1 CRC error but less than 5 CRC errors detected at the far end device.

**Far End Medium CRC Error Seconds (F M CRC)** - The number of seconds with at least 5 CRC errors but less than 10 CRC errors detected at the far end device.

**Far End Medium-High CRC Error Seconds (F MH CRC)** - The number of seconds with at least 10 CRC error but less than 100 CRC errors detected at the far end device.

**Display Test Results  
(Continued)**

**Far End Payload Source and Loopback Status (PAY SRC)** - Indicates the direction of the PRM as indicated by the PRM Command/Response bit (C/R) and the Payload Loopback Activated bit (LB). In end-to-end applications, a customer-generated PRM is indicated when R = 1 and LB = 0. A carrier-generated PRM is indicated as CARR (C/R = 1) and LB = 0. In payload loopback applications, the customer-generated PRM is indicated as CUST LOOP (C/R = 0 and LB = 1). When the customer is looped back, the carrier-generated PRM is indicated as CARR LOOP (C/R = 1 and LB = 1).

**Far End Severe CRC Error Seconds (F SV CRC)** - The number of seconds with more than 320 CRC errors detected at the far end device.

**Far End Severely Errored Frame Seconds (F F SES)** - The number of seconds with 2 or more frame errors occurring within 3 milliseconds detected at the far end device.

**Far End Single CRC Error Seconds (F SI CRC)** - The number of seconds with 1 CRC error detected at the far end device.

**FAS Error Rate (FAS E Rate)** - In 2048 kb/s testing, the ratio of the number of FAS errors detected over the last test interval to the number of frame words examined in the last test interval.

**Frame Alignment Signal Errors (FAS ERR)** - In 2048 kb/s testing, the number of FAS errors detected since the beginning of the test.

**Frame Check Sequence Errors (FCS ERR)** - In ISDN testing, the number of frames with an incorrect CRC set.

**Frame Error Rate (F E Rate)** - The ratio of the number of frame errors counted over the last test interval to the number of framing bits examined in the last test interval.

**Frame Errors (FRA ERR)** - The number of errored framing bits detected since the beginning of the test.

**Frame Losses (FRA LOSS)** - The number of times that frame synchronization has been lost since the beginning of the test.

**Frame Reject Frames (FRMR)** - In ISDN testing, the number of frame rejection frames sent by the peer entity in response to an unrecognized entity (e.g., bad flag, unknown command).

**Layer 2 Aborts (L2 ABORT)** - In ISDN testing, the number of layer 2 frame aborts. Frame aborts terminate the LAPD frame in progress without processing.

**Layer 2 Frame Errors (L2 F ERR)** - In ISDN testing, the number of layer 2 frame errors. Caused by receiving an LAPD frame (packet) that does not have an integral number of octets.

**Maximum Consecutive Zeros (MAX ZERO)** - The maximum number of consecutive zeros received since the last test restart.

**Multiframe Alignment Signal Word Error (MFAS ERR)** - The number of errored MFAS words detected in TS16.

**Number of Layer 2 Frames (L2 FRMS)** - In ISDN testing, the total number of Layer 2 frames received.

**One-Second CRC Errors (1 SEC CRC)** - The number of CRC errors counted in the last test second.

**Parity Errors (PAR ERR)** - The number of parity errors detected since the test started.

**Performance Report Message Time (PRM TIM)** - The number of seconds, since test restart, in which valid PRM data was received.

## ANALYSIS RESULTS

## ANALYSIS RESULTS

**Display Test Results  
(Continued)**

**Received ABCD (RX ABCD)** - In T1 testing, the ABCD signal of a DS0 channel selected via the interface set-up menu.

**Received Bit Oriented Message (RCV BOM)** - In T1 testing, one of five ASCII messages on the ESF data link, as follows:

- YEL ALM - yellow alarm
- LLB ACT - line loopback activate
- LLB DEA - line loopback deactivate
- PLB ACT - payload loopback activate
- PLB DEA - payload loopback deactivate

Received BOMs not listed are displayed in binary form.

**Received FEAC Code (RCV FEAC)** - The number of far end alarm control codes received. The FEAC is a 6-digit code with the following meanings:

Code	Mnemonic	Meaning
011001	DS3 EQF1	DS3 Equipment Failure (Type 1)
001110	DS3 LOS	DS3 Signal Loss/High Bit Error Rate
000000	DS3 OOF	DS3 Out-Of-Frame
010110	DS3 AIS	DS3 Alarm Indication Signal Received
011010	DS3 IDLE	DS3 Idle Code Received
001111	DS3 EQF2	DS3 Equipment Failure (Type 2)
011101	COM EQF2	Common Equipment Failure (Type 2)
010101	MDS1 LOS	Multiple DS1 Loss/High Bit Error Rate
000101	DS1 EQF1	DS1 Equipment Failure (Type 1)
011110	DS1 LOS	Single DS1 Loss/High Bit Error Rate
000011	DS1 EQF2	DS1 Equipment Failure (Type 2)

**Received Frame Alignment Signal Word (RCV FAS)** - The received FAS word.

**Received Multiframe Alignment Signal Word (RCV MFAS)** - The received MFAS word.

**Received Not Frame Alignment Signal Word (RCV NFAS)** - The received not FAS word.

**Received X Bits (RX X1:X2)** - The current of the received X1 and X2 bits.

**Reject Frames (REJ FRM)** - In ISDN testing, the number of rejection frames sent by the peer entity in response to a frame received with an FCS (CRC) error.

**Remote End Block Error Rate (REBE Rt)** - The rate at which remote end block errors are detected.

**Remote End Block Errors (REBE)** - The number of remote end block errors detected.

**Violation-Free Error Analysis Seconds (V F EAS)** - The number of error analysis seconds during which no BPVs or code errors were detected.

**Display Test Results  
(Continued)**

**ALARM Category**

The FIREBERD 6000 monitors several alarm conditions and counts the number of times each one occurs. Alarms such as signal, pattern sync, data, clock, or power loss indicate conditions that affect the test in progress.

**Alarm Indication Signal Seconds (AIS SEC)** - The number of seconds since the beginning of the test in which the AIS alarm was active.

**Clock-Data Phase Change (C-D CHA)** - The number of times that the clock-data phase has changed since the beginning of the test.

**Excess Zero Seconds (XS0 SEC)** - The number of seconds since the beginning of the test in which excess zeros have occurred.

**Far End Out-Of-Frame Seconds (FEOOF S)** - A count of the number of seconds in which the far end is out of frame synchronization.

**Frame Alignment Signal Distant Alarm Seconds (FAS DIS S)** - A count of the number of seconds in which the distant FAS is detected.

**Multiframe Alignment Signal Distant Alarm Seconds (MF DIS S)** - A count of the number of seconds in which the distant MFAS is detected.

**Near End Out-Of-Frame Seconds (NEOOF S)** - A count of the number of seconds in which the near end is out of frame synchronization.

**Ones Density Seconds (1s DEN S)** - The number of seconds since the beginning of the test in which ones density violations have occurred.

**Pattern Synchronization Loss Count (PAT LOSS)** - The number of times a pattern synchronization loss is detected.

**Power Loss (PWR LOSS)** - The number of power losses since the last manual test restart or major switch change.

**Receiver Clock Loss Count (CLK LOSS)** - The number of times a receiver sync loss results from a loss of receiver clock.

**Receiver Data Loss Count (DAT LOSS)** - The number of times a receiver synchronization loss results from a loss of receiver data.

**Signal Loss (SIG LOSS)** - The number of times the receiver signal is lost.

**Timeslot 16 Alarm Indication Signal Seconds (TS16AIS S)** - A count of the number of seconds in which the AIS occurred in timeslot 16.

**Violated Frame Seconds (V FR SEC)** - A count of the number of seconds in which there was at least one violated frame.

**Yellow Alarm Seconds (YEL SEC)** - The number of seconds since the beginning of the test in which a yellow alarm was active.



AUX FUNC IN USE

Status-Select Auxiliary Function In Use

AUX FUNC IN USE

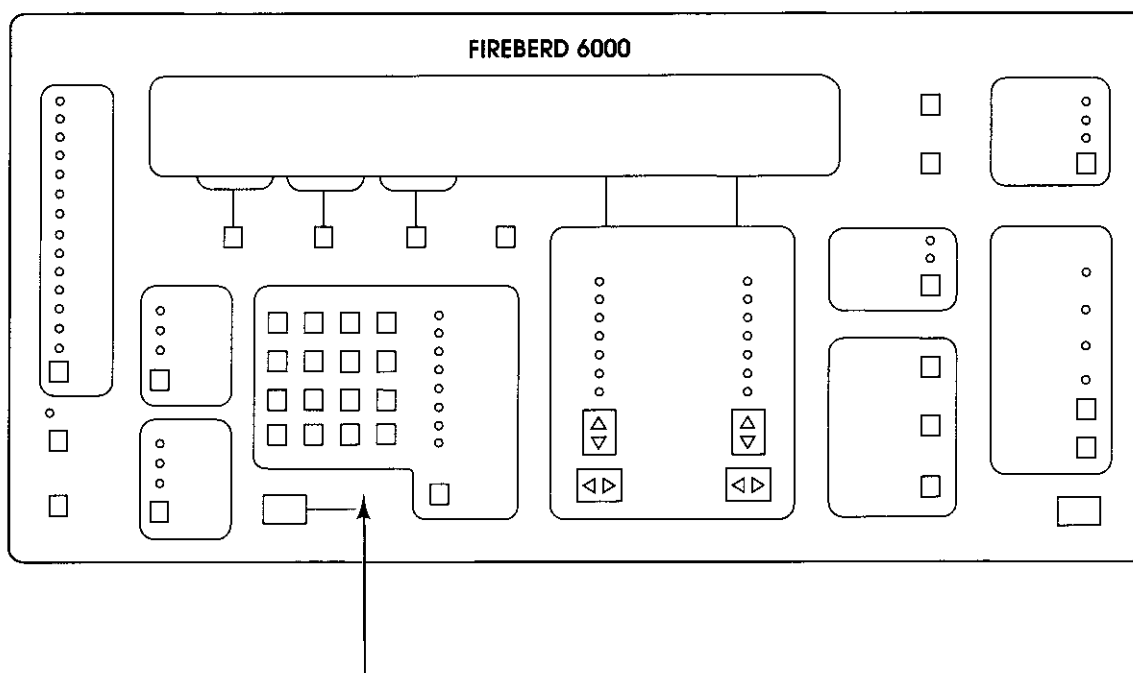
**Front-Panel Component-Type:**

Panel label with backlighting.

**Purpose:**

The AUX FUNC IN USE label indicates that at least one of the FIREBERD 6000 status-select auxiliary functions (1 to 10 and 12) is not at its default state.

For example, the default setting for generator clock polarity (auxiliary function 01) is NORMAL; when generator clock polarity is set to INVERT, the AUX FUNC IN USE label is illuminated.

Note that only auxiliary functions 1-10 and 12 are classified as status-select.

## Instrument Description

CLK INV

CLK INV

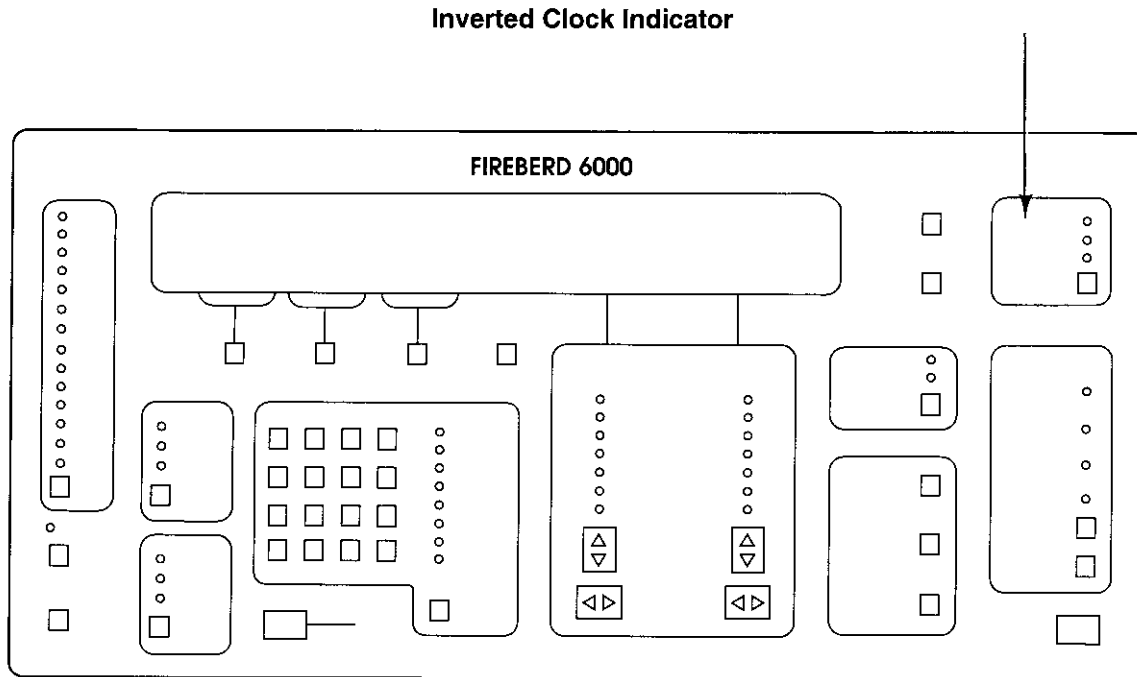

### Front-Panel Component-Type:

Panel label with backlighting.

### Purpose:

When conducting an out-of-service test with an interface, such as an RS-232, V.35, or RS-449 data interface, the CLK INV indicator illuminates when the FIREBERD 6000 detects an improper phase relationship between the incoming clock and data.

For example, if the sampling edge of the clock (as defined by the applicable interface standard) is, on the average, closer to the data transitions than to the mid-bit position of the data, an inverted clock condition is declared and the CLK INV label is backlit.

### Note:

1. Inverted clock detection takes place only when the FIREBERD 6000 is in synchronous timing mode.

The inverted clock detector determines if the phase relationship between the receive clock and data is correct. If the clock is inverted with respect to what is specified for the data interface, the CLK INV indicator illuminates. Such detection only takes place when synchronous timing is selected. Auxiliary function 02 (Receiver Clock Polarity) does not affect the operation of the inverted clock detector.

CODE

Code Indicator

CODE

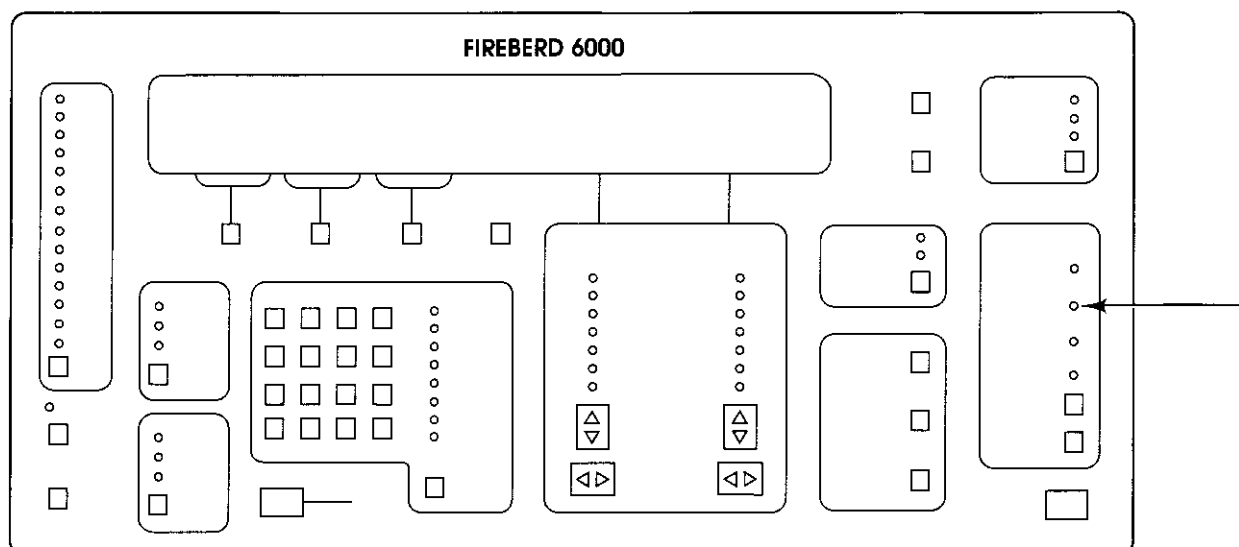
**Front-Panel Component-Type:**

Discrete LED indicator with adjacent label.

**Purpose:**

When the FIREBERD 6000 is used to test an interface, such as a T1 or DDS data interface, the CODE indicator illuminates when a specific type of code is received. Refer to your individual interface manual for what the CODE LED means.

CTS LED INDICATOR

Clear To Send (CTS) Indicator

CTS LED INDICATOR

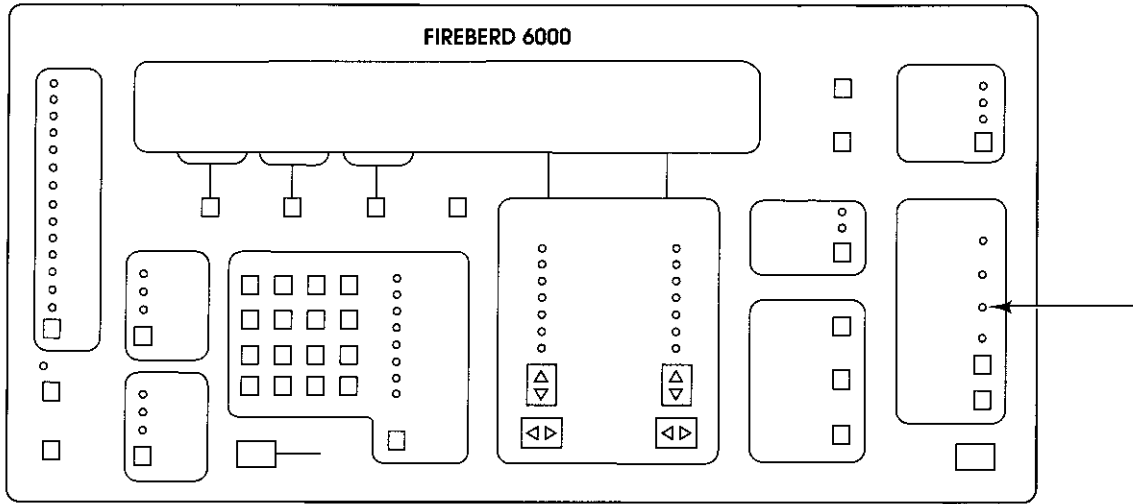

Front-Panel Component-Type:

Discrete LED indicator with adjacent label.

Purpose:

When a data interface, such as RS-232, V.35, or RS-449 is selected, and the FIREBERD 6000 is emulating a DTE, the CTS indicator shows the state of the connecting DCE Clear To Send (CTS) signaling lead.

Notes:

1. The enabling of signaling leads is an activity normally associated with out-of-band flow control. In out-of-band flow control, data transmission takes place only when certain signaling leads are placed in the ON state (i.e., enabled). In either DTE or DCE emulation, data transmission may be conditioned upon the enabling of any or all of these leads:

<u>Signaling Lead:</u>	<u>Described on Page:</u>
CTS	2-34
DSR (DM)	2-42
DTR (TR)	2-44
RLSD (RR)	2-82
RTS	2-84

2. Auxiliary function 08 (OUT-BAND FLOW) allows the user to specify which signaling leads must be in the ON state for data transmission to take place.

DATA

DATA

## Select A Data Pattern Or Message

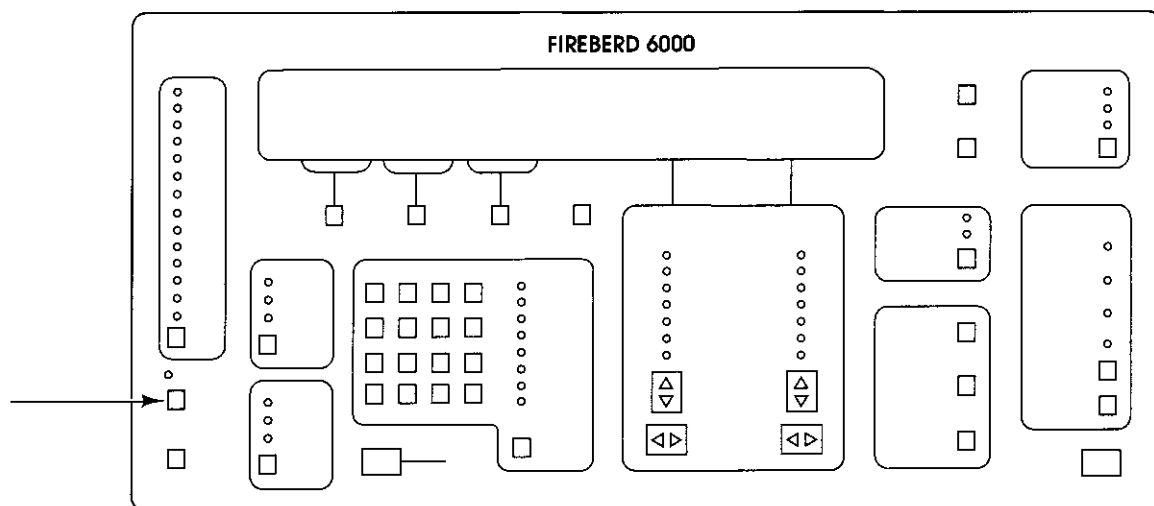
**Front-Panel Component-Type:**

Multifunction switch.

**Purpose:**

The **DATA** switch selects a pattern or message to be transmitted when conducting an out-of-service test. In out-of-service testing, live traffic must be removed from the digital circuit before testing can begin. In its place, the FIREBERD 6000 transmits the currently selected data pattern either to another test instrument or to itself via loopback. The received data is then analyzed for errors.

**Pattern:****Description:****Provides:**

MARK

All ones, fixed, "keep-alive" pattern. Equivalent to Red Alarm Signal.

Maximum power level for T1 signal. Stresses T1 repeater's minimum power requirements. Also useful for signal tracing or as an ideal pattern.

1:1

Fixed pattern of single alternating Marks and Spaces.

Minimum stress on clock recovery circuits.

63

$2^6-1$  pseudorandom pattern with a maximum of 5 sequential zeros and 6 sequential ones.

Lowest stress of any pseudorandom pattern. Recommended for synchronous and asynchronous testing.

511

$2^9-1$  pseudorandom pattern with a maximum of 8 sequential zeros and 9 sequential ones.

Compatible with DDS equipment. Recommended when testing below the rate of 9.6 kb/s.

2047

$2^{11}-1$  pseudorandom pattern with a maximum of 10 sequential zeros and 11 sequential ones.

Compatible with DDS equipment. Suited for testing at data rates between 9.6 and 56 kb/s.

**DATA**

**DATA**

**Select a Data Pattern or Message  
(Continued)**

**Notes (continued):**

<u>Pattern:</u>	<u>Description:</u>	<u>Provides:</u>
2 <sup>15</sup> -1	Pseudorandom pattern with a maximum of 14 sequential zeros and 15 sequential ones.	Compatible with O.151 specification for 64,1544, 2048, 3152 and 6312 kb/s data rates. Provides maximum number of sequential zeros allowable in framed, non-B8ZS testing. Recommended for testing at data rates above 19.2 kb/s. Standard for G.703 testing.
2 <sup>20</sup> -1	Pseudorandom pattern with a maximum of 19 sequential zeros and 20 sequential ones.	Higher stress than the 2 <sup>15</sup> -1 pattern. Recommended for T1 applications where excess zero transmission is required. Cannot be used in asynchronous timing mode.
2 <sup>23</sup> -1	Pseudorandom pattern with a maximum of 22 sequential zeros and 23 sequential ones.	Highest stress of all pseudorandom patterns. Cannot be used in asynchronous timing mode.
QRSS	2 <sup>20</sup> -1 pattern modified to transmit a maximum of consecutive zeros.data	Simulation of live data. QRSS is the standard 14 pattern for T1 testing. Cannot be used in asynchronous timing mode.
PRGM	A user-programmable bit pattern, configured using auxiliary function 33.	The ability to generate a 3-to-24 bit user-programmable pattern.
FOX	A message that includes the numbers 0-9 and all upper case letters (THE QUICK BROWN FOX JUMPS OVER THE LAZY DOG 0123456789). When both the Long User Pattern and synchronous timing are used, a 7-bit QUICK BROWN FOX ASCII message is transmitted.  In asynchronous mode, the FOX message is transmitted according to the number of data bits specified in the character format.  5 bits: Baudot 6 bits: BCDIC 7 bits: ASCII 8 bits: EBCDIC	The standard asynchronous pattern for teletype communications. Also useful as the payload of synchronous protocols.
USER	Selects the pattern currently specified in auxiliary function 41.	The ability to use one of three Long User Patterns programmed in auxiliary function 41, or one of the additional stress patterns offered.

**Notes:**

1. In addition to the patterns which can be selected by the **DATA** switch, additional patterns are available using auxiliary function 41. Auxiliary function 41 patterns are as follows:

DATA

DATA

**Select a Data Pattern or Message  
(Continued)**

**Notes (continued):**

<u>Pattern:</u>	<u>Description:</u>	<u>Provides:</u>
USER1	A user-created message of up to 2048 hexadecimal characters. When a USER1 message is not programmed, the default pattern is T1-6.	A lengthy, user-specific test pattern. A FIREBERD equipped with Long User Pattern capability is required when in synchronous or recovered timing mode.
USER2	Same as USER1, with the exception of the default pattern: a 7-bit ASCII QUICK BROWN FOX message.	A lengthy, user-specific test pattern. A FIREBERD equipped with Long User Pattern capability is required in synchronous or recovered timing mode.
USER3	Same as USER2, with the exception of the default pattern: an 8-bit EBCDIC QUICK BROWN FOX message.	A lengthy, user-specific test pattern. A FIREBERD equipped with Long User Pattern capability is required in synchronous timing mode.
1:7	Long User Pattern of 1 Mark and 7 Spaces.	Maximum stress of the 12.5% one's density requirements for T1 circuits. Cannot be used in asynchronous timing mode.
3IN24	Long User Pattern, a 24-bit pattern of 1 Mark and 3 Spaces (3 times) followed by 15 consecutive Spaces. The pattern appears as 1000 1000 1000 0000 0000 0000.	Maximum stress of the excess zero requirement for T1 circuits. Cannot be used in asynchronous timing mode.
DDS-1	Long User Pattern of 100 octets with all ones (1111 1111), followed by 100 octets with all zeros (0000 0000).	Stress any DDS circuit's minimum and maximum power requirements for signal recovery. A FIREBERD equipped with Long User Pattern capability is required. Cannot be used in asynchronous timing mode.
DDS-2	Long User Pattern of 100 octets of 0111 1110, followed by 100 octets of all zeros.	Simulation of an HDLC packet frame. A FIREBERD equipped with Long User Pattern capability is required. Cannot be used in asynchronous timing mode.
DDS-3	Fixed pattern 0100 1100.	Minimum stress test of a DDS circuit. Cannot be used in asynchronous timing mode.
DDS-4	Fixed pattern 0000 0010.	Moderate stress on DDS clock recovery circuits. Cannot be used in asynchronous timing mode.
DDS-5	Long User Pattern, consisting of DDS patterns 1-4.	A quick test for those wishing to test a circuit with DDS patterns 1-4.
DDS-6	Long User Pattern, a 7-octet fixed pattern of 1111 1110 followed by 1 octet of 1111 1111.	Simulation of a DDS signal transition from IDLE mode to DATA mode. Detects marginal equipment in multi-point applications. A FIREBERD equipped with Long User Pattern capability is required. Cannot be used in asynchronous timing mode.

DATA

DATA

Select a Data Pattern or Message  
(Continued)

Notes (continued):

<u>Pattern:</u>	<u>Description:</u>	<u>Provides:</u>
T1-1	<p>Long User 72-octet hex pattern:                      80 80 80 80 01 00 01 01                      01 03 80 01 80 01 01 80                      01 22 00 20 22 00 20 AA                      AA AA AA AA 55 55 55 55                      AA AA AA AA 55 AA AA 55                      55 55 80 80 FF FF FF FF                      FF FF FF FE FF FF 24 49                      92 88 88 88 10 42 08 21                      84 20 08 82 40 20 10 80.</p>	<p>Stress testing of the repeater preamplifier and automatic line build-out (ALBO) circuitry. Detect marginal equipment using rapid transitions from a low one's density to a high ones density. A FIREBERD equipped with Long User Pattern capability is required. Not available in a synchronous timing mode.</p>
T1-2	<p>Long User 96-octet hex pattern:                      FF FF FF FF FF FF FF FF                      FF FF FF FF FF FF FF FF                      FF FF FF FF FF FF FF FF                      FF FF FF FF FF FF FF FF                      FF FF FF FF FF FF FF FF                      FF FF FF FF FF FF FF FF                      AA AA AA AA 80 01 80 01                      80 01 80 01 80 01 80 01                      80 01 80 01 80 01 80 01                      AA AA AA AA 80 01 80 01                      80 01 80 01 80 01 80 01                      80 01 80 01 80 01 80 01.</p>	<p>Empirical stress testing of T1 circuits and equipment. A FIREBERD equipped with Long User Pattern capability is required. Not available in asynchronous timing mode.</p>
T1-3	<p>Long User 54-octet hex pattern:                      01 01 01 01 01 01 00 01                      01 01 01 01 01 03 01 01                      01 01 07 01 01 01 01 55                      55 55 55 AA AA AA AA 01                      01 01 01 01 01 FF FF FF                      FF FF FF 80 01 80 01 80                      01 80 01 80 01 80.</p>	<p>Empirical stress testing of T1 circuits and equipment. A FIREBERD equipped with Long User Pattern capability is required. Not available in asynchronous timing mode.</p>
T1-4	<p>Long User 120-octet hex pattern:                      FF FF FF FF FF FF FF FF                      FF FF FF FF FF FF FF FF                      FF FF FF FF FF FF FF FF                      FF FF FF FF FF FF FF FF                      FF FF FF FF FF FF FF FF                      FF FF FF FF FF FF FF FF                      FF FF FF FF FF FF FF FF                      FF FF FF FF FF FF FF FF                      FF FF FF FF FF FF FF FF                      AA AA AA AA 10 10 10 10                      10 10 10 10 10 10 10 10                      10 10 10 10 10 10 10 10                      AA AA AA AA 10 10 10 10                      10 10 10 10 10 10 10 10                      10 10 10 10 10 10 10 10.</p>	<p>Empirical stress testing of T1 circuits and equipment. A FIREBERD equipped with Long User Pattern capability is required. Not available in asynchronous timing mode. Since it contains false ESF framing bits, it should not be used in ESF framed mode.</p>



DATA

DATA

**Select a Data Pattern or Message  
(Continued)**

**Notes (continued):**

<u>Pattern:</u>	<u>Description:</u>	<u>Provides:</u>
T1-5	<p>Long User 53-octet hex pattern:            80 01 80 01 80 01 80 01            80 01 80 01 80 01 80 01</p> <p>80 01 80 01 80 01 80 01            80 01 80 01 80 01 01 AF            AA AF 01 01 01 01 FF FF            FF FF 01 01 01 01 FF FF            FF FF FF FF CB.</p>	<p>Empirical stress testing of T1 circuits and equipment. A FIREBERD equipped with Long UserPattern capability is required. Not available in asynchronous timing mode.</p>
T1-6	<p>Long User 55-octet hex pattern:            01 01 01 01 01 01 00 01            01 01 01 01 01 03 01 01            01 01 07 01 01 01 01 55            55 55 55 AA AA AA AA 01            01 01 01 01 01 FF FF FF            FF FF FF 80 01 80 01 80            01 80 01 80 01 80 01.</p>	<p>Empirical stress testing of T1 circuits and equipment. A FIREBERD equipped with Long UserPattern capability is required. Not available in asynchronous timing mode.</p>
T1-DALY	<p>Long User 55-octet hex pattern:            01 01 01 01 01 01 80 01            01 01 01 01 01 03 01 01            01 01 07 01 01 01 01 55            55 55 55 AA AA AA AA 01            01 01 01 01 01 FF FF FF            FF FF FF 80 01 80 01 80            01 80 01 80 01 80 01.</p>	<p>Same as T1-6, except that byte 7 is 80 instead of 00.</p>
T1-mW	<p>Long User Pattern digitized 1004 Hz tone with a 0 dBm0 level on one DS-0 channel. This pattern length is 247 bytes.</p>	<p>Standard tone (<math>\mu</math>-law) used in Voice Frequency (VF) testing. A FIREBERD equipped with Long User Pattern capability is required.</p>
1020Hz	<p>Long User Pattern digitized 1020 Hz tone with a 0 dBm0 level on one timeslot. This pattern length is 400 bytes.</p>	<p>Standard tone used in CCITT Voice Frequency (VF) testing. A FIREBERD equipped with Long User Pattern capability is required.</p>

2. Certain data patterns are designed for use with specific data interfaces. The T1-1 to T1-6 patterns are designed for use with the T1 interfaces (e.g., T1/FT1 and DS1/T1). The DDS-1 to DDS-6 patterns are designed for use with the DDS interfaces. These patterns are not compatible when used with another type of interface.

## Instrument Description

DATA INV

Inverted Data Indicator

DATA INV

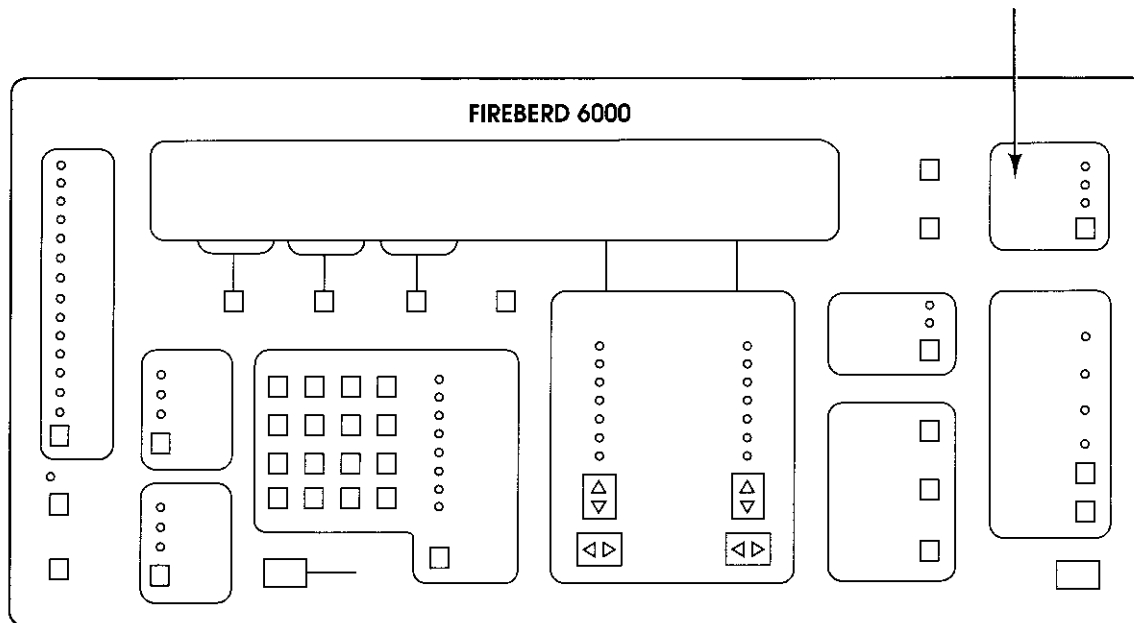

### Front-Panel Component-Type:

Panel label with backlighting.

### Purpose:

When conducting an out-of-service test, the DATA INV indicator illuminates when the FIREBERD 6000 recognizes a data pattern that is the logical opposite of the one it originally expected to receive.

### Notes:

1. The FIREBERD 6000 checks for data inversion if pattern synchronization has not been achieved after receipt of the first 128 bits in SYNC mode, or after 5 seconds have elapsed in ASYNC mode. When data inversion is detected, the FIREBERD 6000 uses its auto polarity circuits to reinvert the data, and enable both pattern synchronization and error analysis.
2. The Long User Pattern (i.e., user-created message of up to 2048 characters in length, programmed in USER1, USER2, or USER3) cannot synchronize to inverted data. See auxiliary function 41 (described later in this section) for information on the long user pattern).

DISPLAY HOLD

Freeze Analysis Results

DISPLAY HOLD

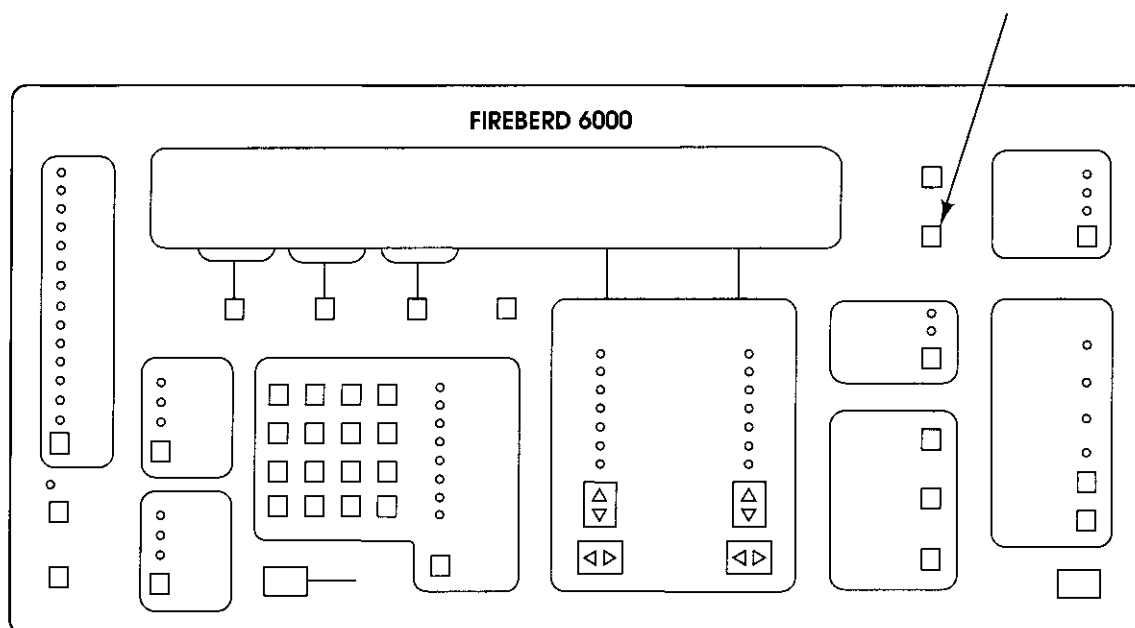
**Front-Panel Component-Type:**

Single-function switch.

**Purpose:**

The **DISPLAY HOLD** switch freezes all analysis results so that the values of these results can be examined. When enabled, a red LED within the switch is illuminated to indicate that the results in the display are *not* the most current. Pressing the **DISPLAY HOLD** switch while it is illuminated enables the test results to be updated, and returns the displays to normal operation.

**Instrument Description**

**DSR (DM) LED INDICATOR**

**DSR (DM) LED INDICATOR**

**Data Set Ready (DSR) Indicator**

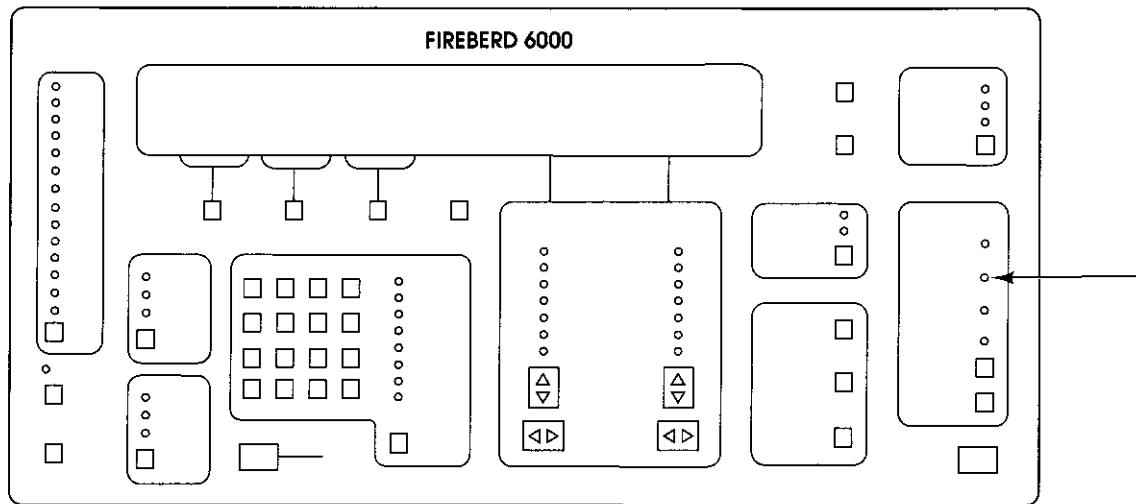

**Front-Panel Component-Type:**

Discrete LED indicator with adjacent label.

**Purpose:**

When a data interface, such as RS-232, V.35, or RS-449 is selected, and the FIREBERD 6000 is emulating a DTE, the DSR (DM) indicator illuminates when the connecting DCE has enabled the Data Set Ready (DSR) signaling lead. When the DSR (DM) indicator is not illuminated, the DCE DSR signaling lead is disabled.

DSR (DM) SWITCH

## Data Set Ready (DSR) Line Control

DSR (DM) SWITCH

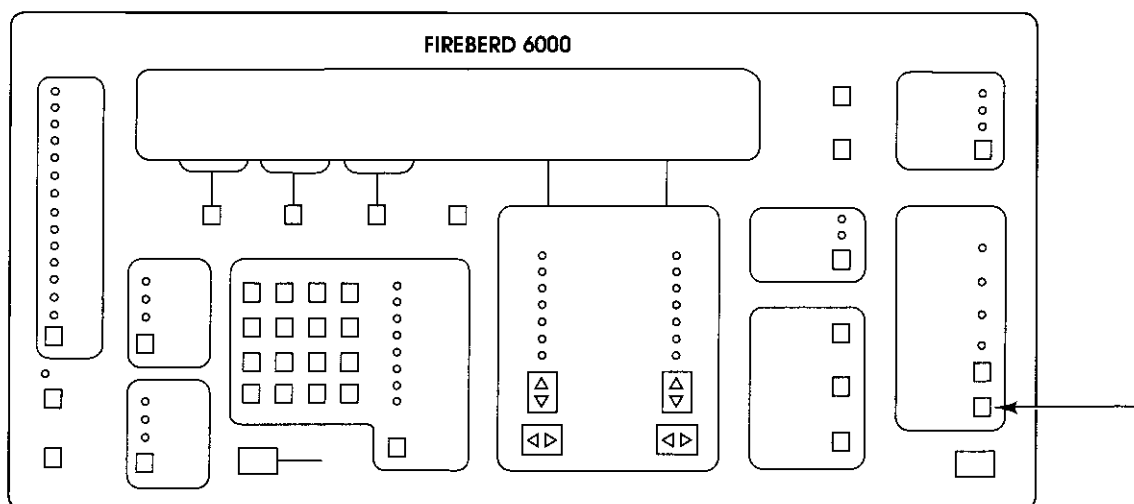
**Front-Panel Component-Type:**

Single-function switch.

**Purpose:**

When a data interface, such as RS-232, V.35, or RS-449 is selected, and the FIREBERD 6000 is emulating a DCE, the **DSR (DM)** switch controls the state of the DSR signaling lead. When the switch is illuminated, the DSR signaling lead is enabled; otherwise, the DSR signaling lead is disabled.

**Notes:**

1. The enabling of signaling leads is an activity normally associated with out-of-band flow control. In out-of-band flow control, data transmission takes place only when certain signaling leads are placed in the ON state (i.e., enabled). In either DTE or DCE emulation, data transmission may be conditioned upon the enabling of any or all of these leads:

<b><u>Signaling Lead:</u></b>	<b><u>Described on Page:</u></b>
CTS	2-34
DSR (DM)	2-42
DTR (TR)	2-44
RLSD (RR)	2-82
RTS	2-84

2. Auxiliary function 08 (OUT-BAND FLOW) allows the user to specify which signaling leads must be in the ON state for data transmission to take place.

DTR LED INDICATOR

DTR LED INDICATOR

Data Terminal Ready (DTR) Indicator

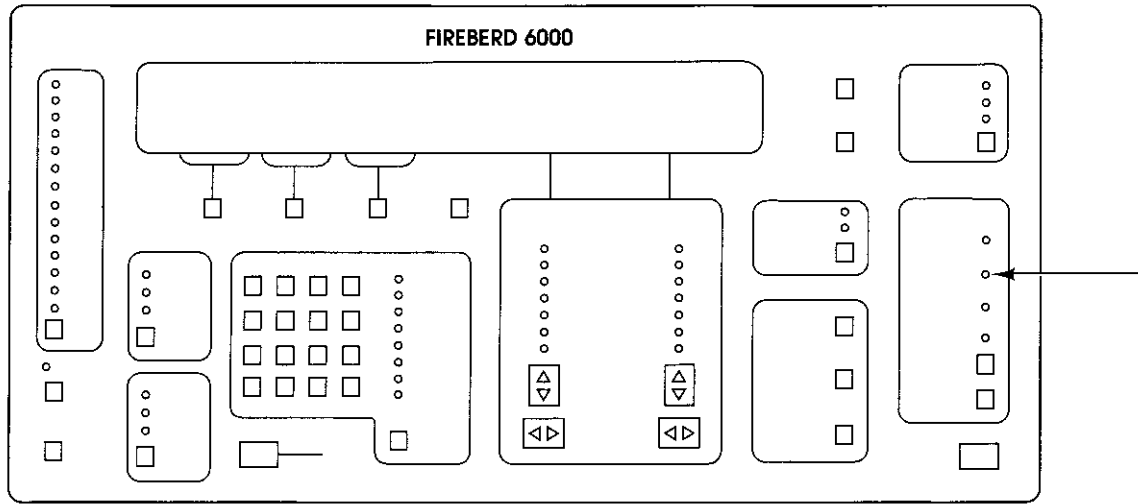

Front-Panel Component-Type:

Discrete LED indicator with adjacent label.

Purpose:

When a data interface, such as RS-232, V.35, or RS-449 is selected, and the FIREBERD 6000 is emulating a DCE, the DTR indicator illuminates when the connecting DTE has enabled the Data Terminal Ready (DTR) signaling lead. When the DTR indicator is not illuminated, the DTE DTR signaling lead is disabled.

DTR SWITCH

DTR SWITCH

## Data Terminal Ready (DTR) Line Control

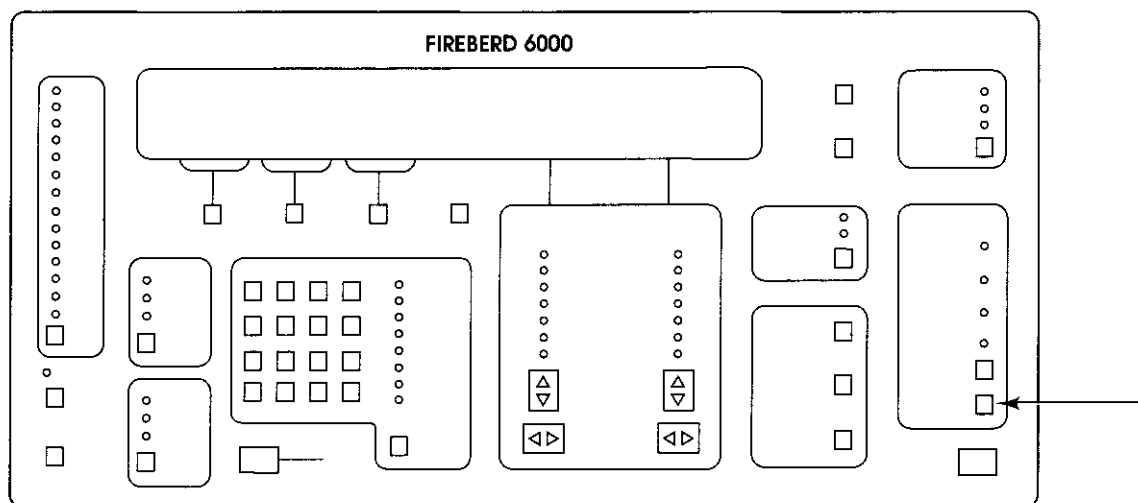
**Front-Panel Component-Type:**

Single-function switch.

**Purpose:**

When a data interface, such as RS-232, V.35, or RS-449 is selected, and the FIREBERD 6000 is emulating a DTE, the **DTR** switch controls the state of the DTR signaling lead. When the switch is illuminated, the DTR signaling lead is enabled; otherwise, the DTR signaling lead is disabled.

**Notes:**

1. Enabling signaling leads is an activity normally associated with out-of-band flow control. In out-of-band flow control, data transmission takes place only when certain signaling leads are placed in the ON state (i.e., enabled). In either DTE or DCE emulation, data transmission may be conditioned upon the enabling of any or all of these leads:

<u>Signaling Lead:</u>	<u>Described on Page:</u>
CTS	2-34
DSR (DM)	2-42
DTR (TR)	2-44
RLSD (RR)	2-82
RTS	2-84

2. Auxiliary function 08 (OUT-BAND FLOW) allows the user to specify which signaling leads must be in the ON state for data transmission to take place. This auxiliary function is fully described later in this section.

EMULATE DCE

EMULATE DCE

FIREBERD 6000 DCE Emulation Indicator

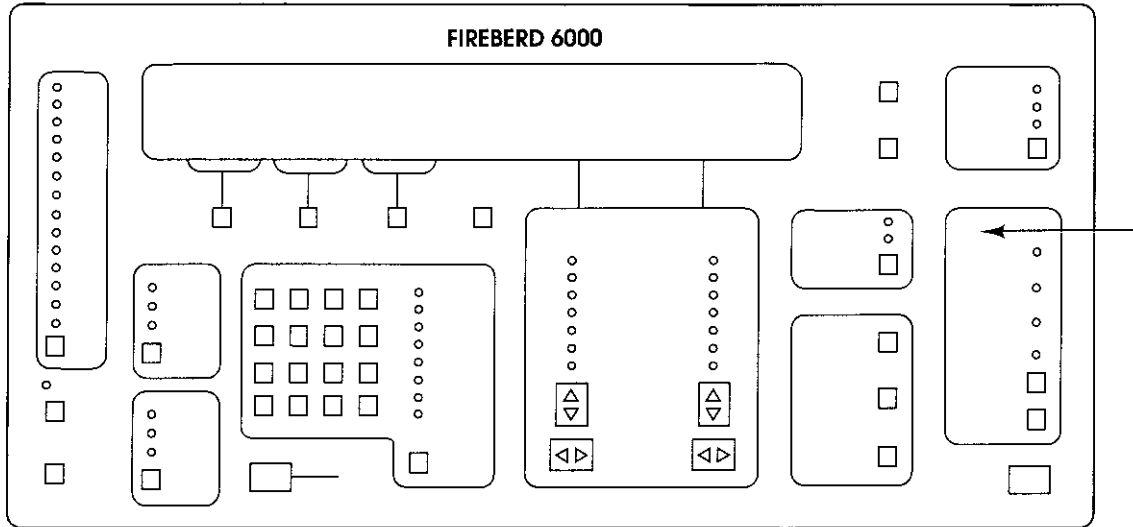

Front-Panel Component-Type:

Panel label with backlighting.

Purpose:

When a data interface, such as RS-232, V.35, or RS-449 is used, this indicator shows that the FIREBERD 6000 is emulating Data Communications Equipment (DCE). Accordingly, the instrument backlights the DCE signaling leads and switches as follows:

<u>Label:</u>	<u>LED/Switch:</u>	<u>Described On Page:</u>
RTS	LED	2-84
DTR	LED	2-44
(LL)	LED	2-51
(RL)	LED	2-81
RLSD (RR)	SWITCH	2-83
DSR (DM)	SWITCH	2-43

Notes:

1. All DCE emulation labels use RS-232 notation; RS-449 notation appears in parentheses.



EMULATE DTE

EMULATE DTE

## FIREBERD 6000 DTE Emulation Indicator

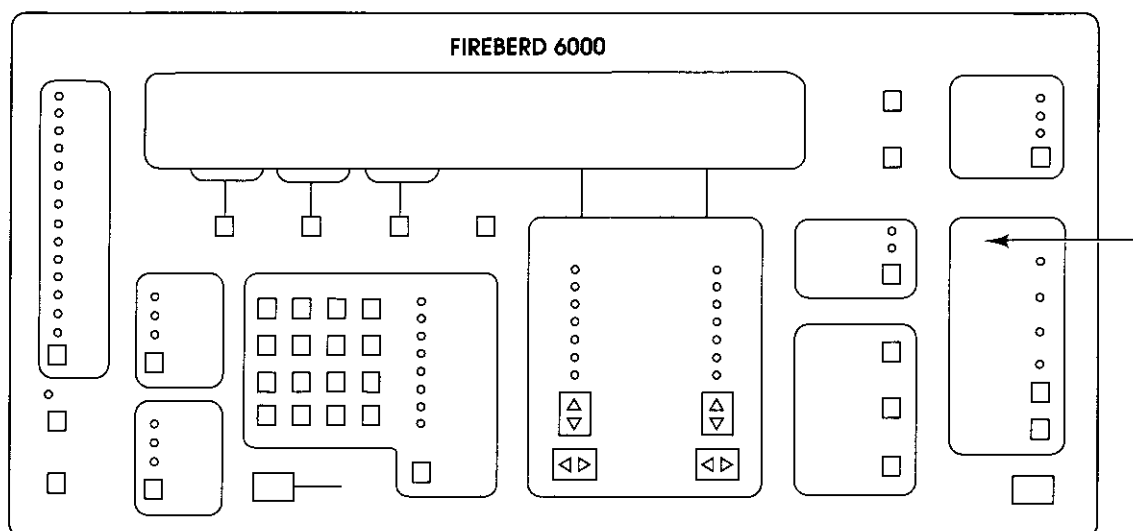
**Front-Panel Component-Type:**

Panel label with backlighting.

**Purpose:**

When a data interface, such as RS-232, V.35, or RS-449 is used, this indicator shows that the FIREBERD 6000 is emulating Data Terminal Equipment (DTE). Accordingly, the instrument backlights the DTE signaling leads and switches as follows:

<u>Label:</u>	<u>LED/Switch:</u>	<u>Described On Page:</u>
RLSD (RR)	LED	2-82
DSR (DM)	LED	2-42
CTS (TM)	LED	2-34 2-96
RTS	SWITCH	2-85
DTR	SWITCH	2-45

**Notes:**

1. All DTE emulation labels use RS-232 notation; RS-449 notation appears in parentheses.

ERROR INSERT

ERROR INSERT

Insert Single or Multiple Errors Into the Data Stream

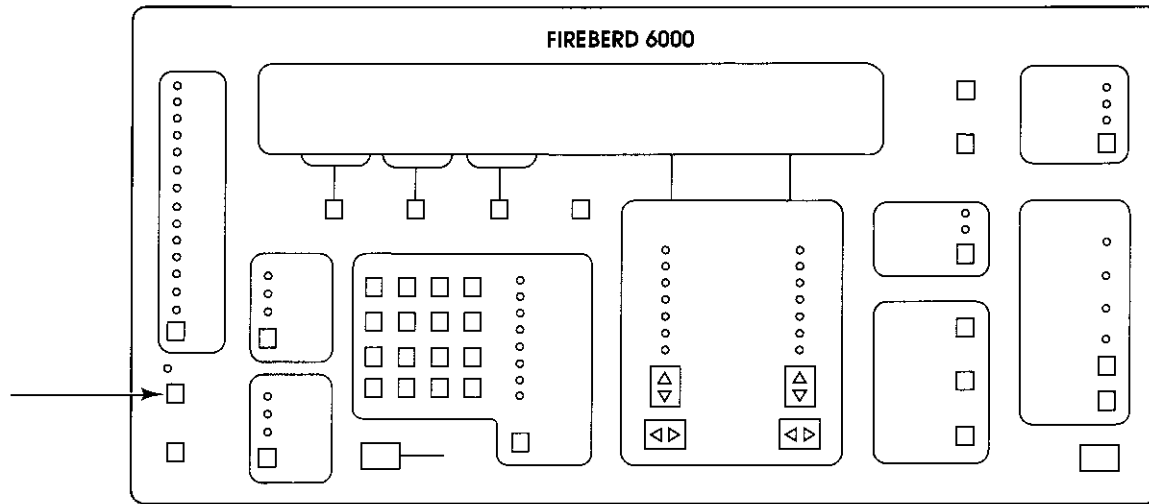

**Front-Panel Component-Type:**

Single-function switch.

**Purpose:**

The **ERROR INSERT** switch inserts a single error when pressed once, or a continuous stream of bit errors, when held pressed in for more than 1 second, into the data stream.

To insert a single error into the data stream, press and immediately release the switch. To insert errors at a continuous rate of 1 in 1000 bits, hold the switch for more than one second; during continuous error insertion, the LED next to the  $10^{-3}$  indicator is illuminated. To turn error insertion off, while the  $10^{-3}$  indicator is illuminated, press and immediately release the switch.

**Notes:**

1. The **ERROR INSERT** switch is disabled when monitoring live data.

FRM SYNC

FRM SYNC

## Frame Synchronization Indicator

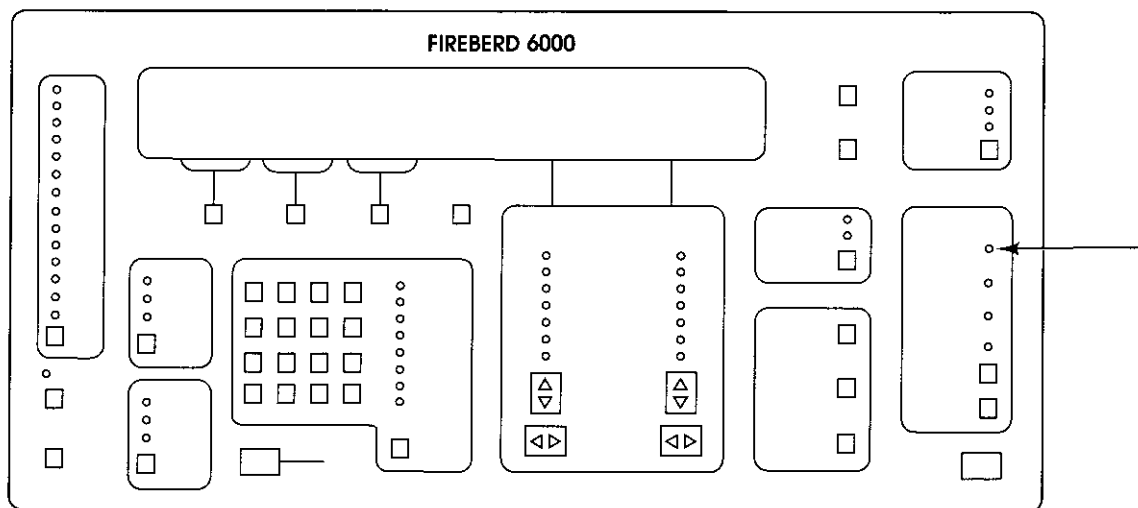
**Front-Panel Component-Type:**

Discrete LED with adjacent label.

**Purpose:**

When using a framed interface, such as T1/FT1, 2MG704, or T3 interface, the FRM SYNC indicator illuminates when synchronization to a valid T1 frame format (i.e., D4, ESF, or SLC-96) is achieved.

When using a DDS interface that can receive a DS0B signal or a DS0A signal at 19.2 kb/s, the FRM SYNC indicator illuminates when synchronization to the appropriate DS0 framing pattern is achieved.

When using the ISDN S/T Interface or a G.703/G.704 interface, the FRM SYNC indicator illuminates when frame synchronization is achieved.

**Notes:**

1. The FRM SYNC indicator does not illuminate when testing unframed T1 or DDS applications.

GEN CLK

GEN CLK

Select a Signal Timing Source

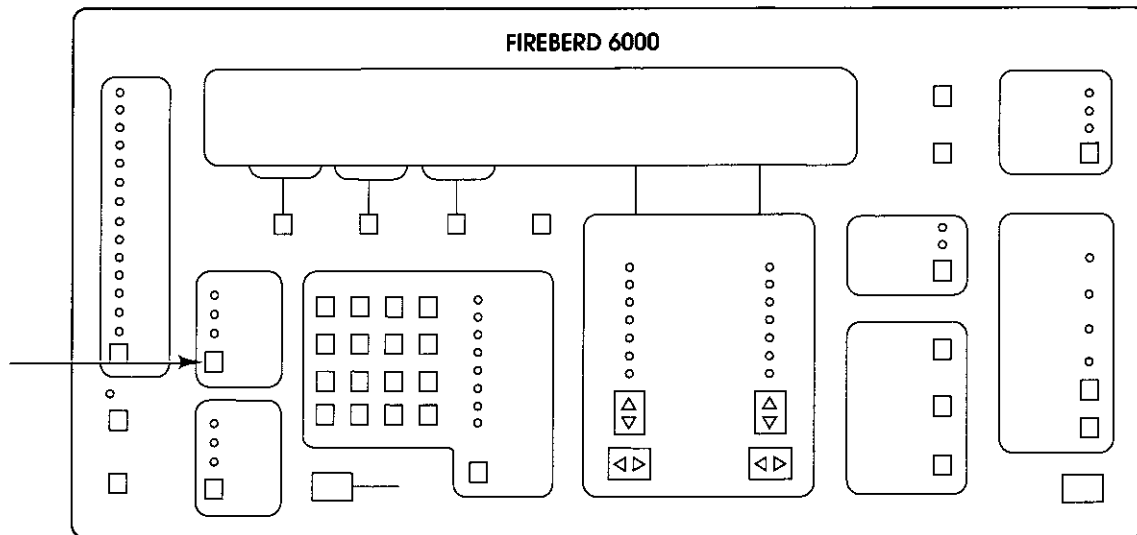

Front-Panel Component-Type:

Multifunction switch.

Purpose:

The **GEN CLK** switch selects the source of signal (transmit) timing when conducting an out-of-service test.

Select:	To:
SYNTH	Choose the FIREBERD 6000 built-in frequency synthesizer as the source of signal timing. The synthesizer generates any frequency within the range of 50 Hz to 15 MHz.
INTF	Choose the clock originating from the network or the clock in the interface module as a source of signal timing.
BNC	Choose an external timing source. When selected, the external timing source must be connected to the BNC connector labeled GEN CLK IN, on the FIREBERD 6000 rear panel.

Notes:

1. The red LED in the **GEN CLK** switch illuminates when a clock signal cannot be detected at the selected signal timing source.
2. When an interface can only operate with one timing source, the **GEN CLK** switch freezes on that selection (i.e., the user cannot change it). When an interface can only operate with two timing sources, the **GEN CLK** switch locks out the invalid choice.
3. For additional information on the **GEN CLK** switch and its operation, refer to the **TIMING MODE** switch description.

(LL) LED INDICATOR

(LL) LED INDICATOR

Local Loopback (LL) Indicator

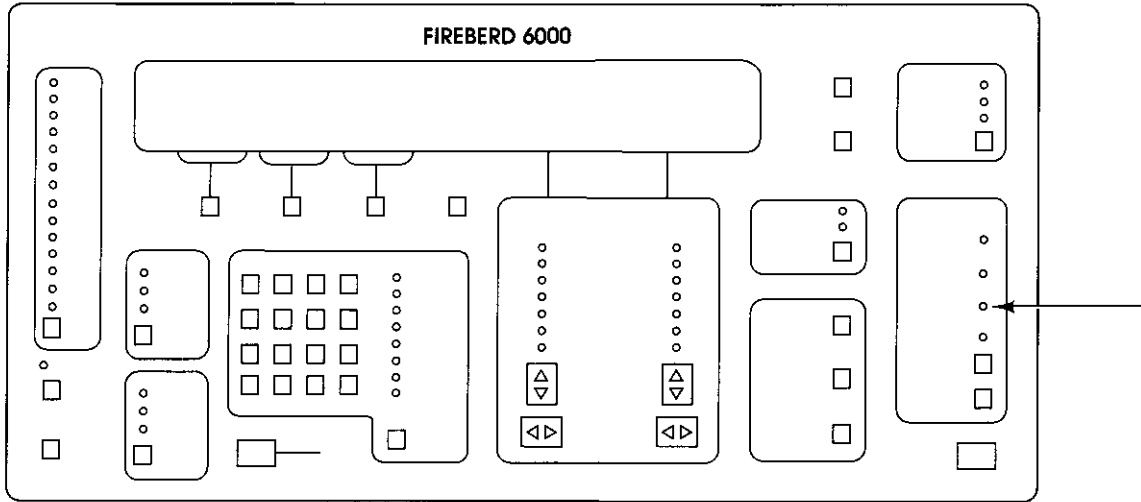

**Front-Panel Component-Type:**

Discrete LED indicator with adjacent label.

**Purpose:**

When a data interface, such as RS-232, V.35, or RS-449 is selected, and the FIREBERD 6000 is emulating a DCE, the (LL) indicator shows the state of the Local Loopback (LL) line. When the indicator is illuminated, the LL line is enabled; otherwise, the LL line is disabled.

LOOP DOWN

LOOP DOWN

Transmit Loop-Down Code

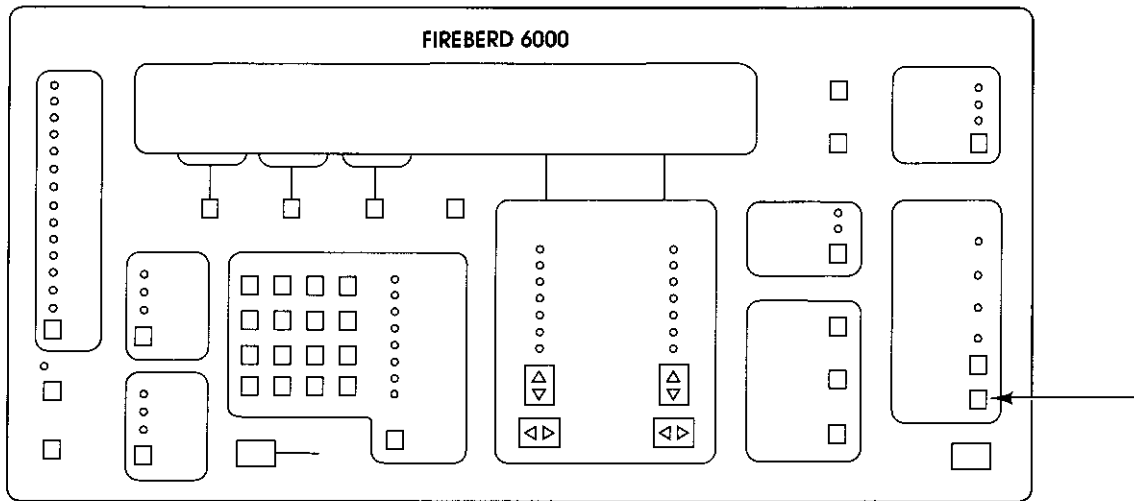

Front-Panel Component-Type:

Single-function switch.

Purpose:

With an appropriate interface, such as T-Carrier or DDS, the **LOOP DOWN** switch controls the transmission of the loop-down code. When the LED in the switch is illuminated, the loop-down code is being transmitted.

Notes:

1. When loop-down code is transmitted, the LED in the **LOOP DOWN** switch is illuminated and the message **Transmitting Loop Code** flashes repeatedly in the Analysis Results display. When the loop-down activity is complete, switch illumination is turned off and the flashing message is cancelled.
2. The **LOOP DOWN** switch should always be used at the conclusion of any loopback test to remove the effect of loop-up code (transmitted via the **LOOP UP** switch) on the circuit under test.

LOOP UP

LOOP UP

## Transmit Loop-Up Code

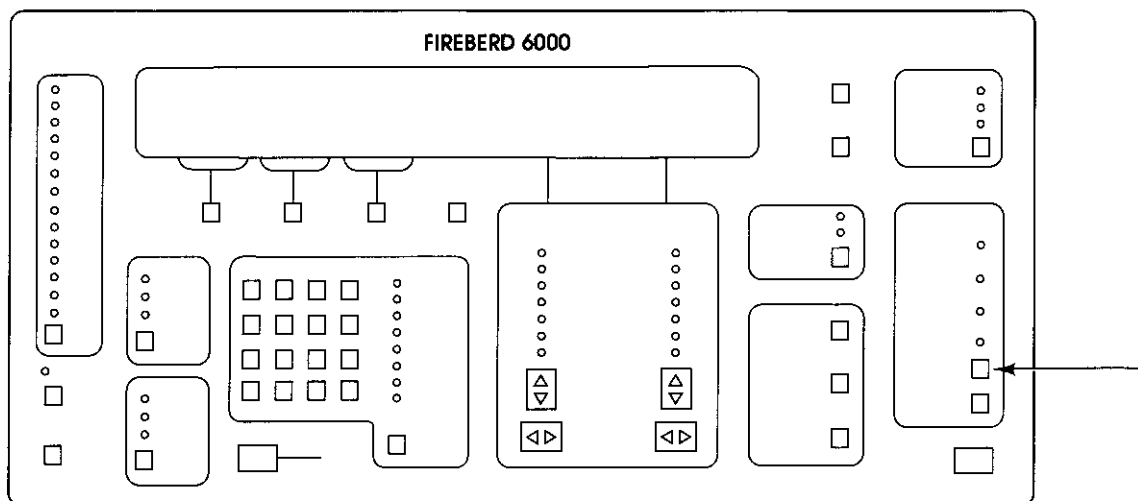
**Front-Panel Component-Type:**

Single-function switch.

**Purpose:**

With an appropriate interface, such as T-Carrier or DDS, the **LOOP UP** switch controls the transmission of the loop-up code. When the LED in the switch is illuminated, the loop-up code is being transmitted.

**Notes:**

1. When the loop-up code is transmitted, the LED in the **LOOP UP** switch is illuminated and the message **Transmitting Loop Code** flashes repeatedly in the Analysis Results display. When the loop-up activity is complete, switch illumination is turned off and the flashing message is cancelled.
2. The **LOOP DOWN** switch must always be used at the conclusion of any loopback test to remove the effect of loop-up code on the circuit under test.

MENU

MENU

Select a Set-Up Menu For Display

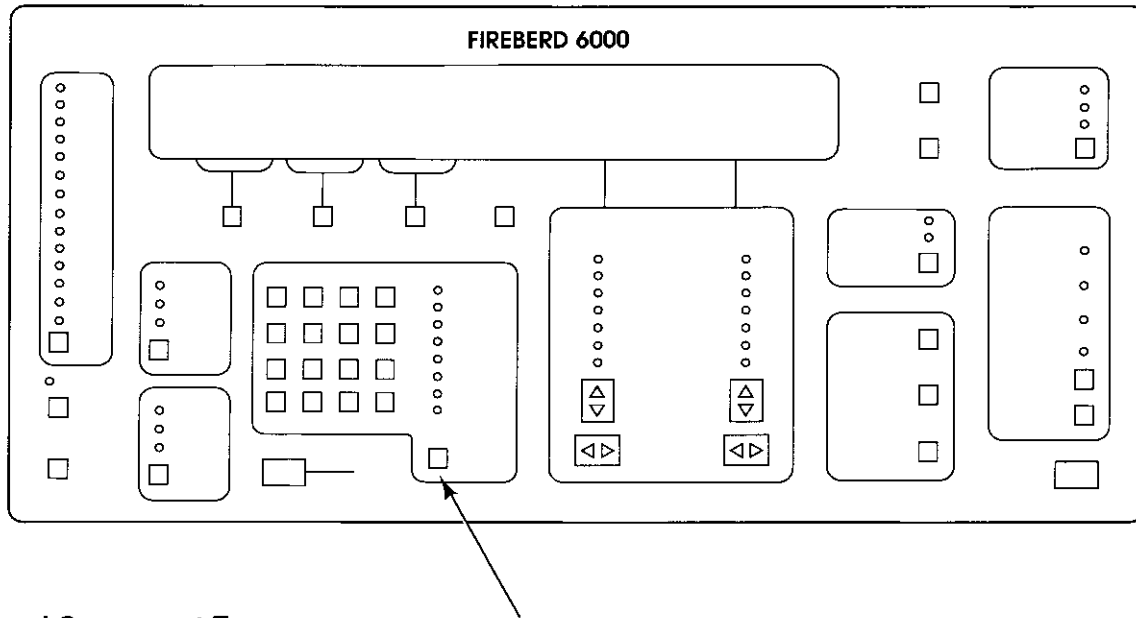

Front-Panel Component-Type:

Multifunction switch.

Purpose:

A key component of the FIREBERD 6000 test set-up facility, the **MENU** switch is used to select one of the following menus for display.

Select:	To:
SYNTH FREQ	Choose a synthesizer frequency.
INTF SETUP	Choose the internal RS232 Interface or the modular interface installed in the rear panel of the FIREBERD 6000.
TEST INTERVAL	Choose a test interval (10 <sup>-4</sup> to 10 <sup>-10</sup> or TIMED).
CHAR FORMAT	Set the asynchronous character format (data, parity, and stop bits).
JITTER	Sets the jitter option parameters.
PRINT EVENT	Set print event criteria (NORMAL or DELTA) for automatically generated print results.
RECALL/STORE	Store, recall, and name up to 10 commonly used unit configurations.
AUXILIARY	Set up any of the additional user-configurable auxiliary functions.



MENU

MENU

### Select a Set-Up Menu For Display (Continued)

The **MENU** switch and each of its individual categories is described in the following paragraphs.

The **MENU** switch is used to select any of the instrument set-up menus for display. These menus are provided for:

- Functions which have a large number of configurable parameters
- Functions that change with data interfaces or options
- Functions requiring numeric or hexadecimal entries

Each function associated with the **MENU** switch is described in the following section.

#### The MENU Display and Softkeys

The MENU display shows the functional menu that is currently selected (by the **MENU** switch). The three MENU softkeys located below the display area control menu movement and selection.

To illustrate how the display and softkeys actually work, Figure 2-3 shows a menu tree of the functions associated with the PRINT EVENT menu.

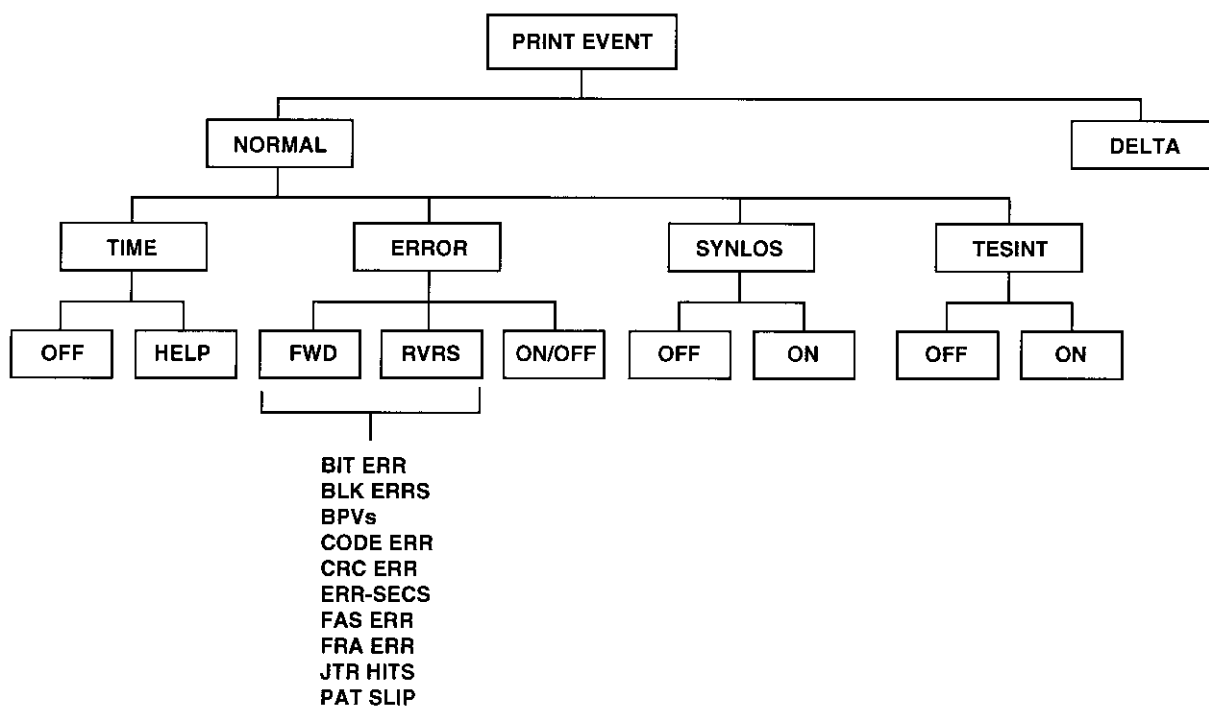
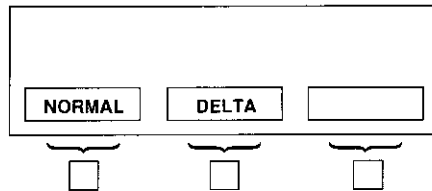

Figure 2-3  
PRINT EVENT Menu Tree

Select a Set-Up Menu For Display  
(Continued)

When PRINT EVENT is selected, the top of the PRINT EVENT menu tree appears in the MENU display. When a softkey is not used, the display area above the bracket is blank.



Pressing the softkey under NORMAL selects the functions associated with standard print events. The MENU display then shows the first three choices at the next level of the NORMAL menu.

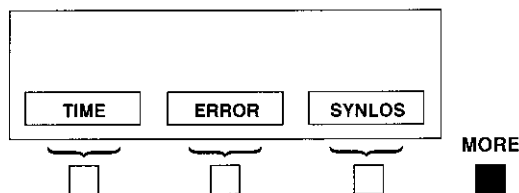

The **MORE** key (located to the right of the MENU softkeys) is illuminated when more than three choices are available at the current menu level. When pressed, the next set of softkey labels are displayed.

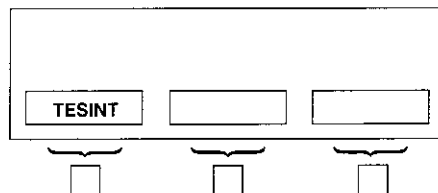

When the softkey under any of these four menu choices is pressed (TIME, ERROR, SYNLOS, TESINT), the PRINT EVENT menu moves to its next level. For example, when the TESTINT softkey is pressed, the ON and OFF softkeys appear in the display.

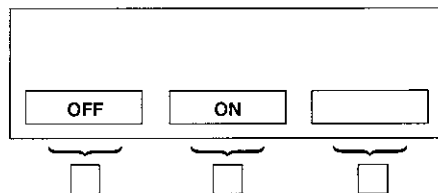

If you desire, you can initiate a printout at the end of each test interval by pressing the ON softkey. Pressing the Up-Arrow ( $\Delta$ ) key, located on the MENU keypad, returns you to the previous level in the menu. If desired, the **ENTER** key can be used to return to the top level of the menu.

**The MENU Keypad**

The MENU keypad is used with functions that have a range of values that are too large to be represented by a softkey. The keypad is also used to move backward through any menu tree and (where applicable) for cursor movement. Table 2-1 describes the components of the MENU keypad

MENU

MENU

**Select a Set-Up Menu For Display**  
(Continued)

**Table 2-1**  
**The MENU Keypad**

Key:	Function:
0 to 9	Numeric entry
Period (.)	Floating decimal point entry (e.g., synthesizer frequency)
SHIFT	Access hexadecimal digits A through F (labeled in blue). For example, to enter an A:  1. PRESS AND RELEASE the <b>SHIFT</b> key. 2. Press the blue-labeled <b>A</b> key.
ENTER	Terminate and implement keypad-entered data. <b>ENTER</b> can also be used to move to the top level of any menu.  Δ Move to previous level in the menu.
> and <	Cursor movement for menus where all or part of a setting can be changed. > Moves cursor to the right. < Moves cursor to the left.

### Cursor Movement

Cursor movement is required for menu functions that have fields of data, such as auxiliary function 60's time and date displays shown below.

```
HH:MM:00 DD/MM/YY
      HELP
```

Note that the cursor is currently positioned under the first digit in the minute (MM) field. To move the cursor to the hour field (HH), press the < key; to move the cursor to the right, press the > key. For example, to change the year (YY), position the cursor under the YY field using the > key:

```
HH:MM:00 DD/MM/YY
      HELP
```

MENU

MENU

Select a Set-Up Menu For Display  
(Continued)

The current year is entered using the appropriate numbers on the keypad; all other fields are unchanged:

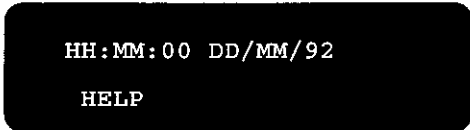

To implement the new setting, press the **ENTER** key.

**Entering a Number Without a Cursor**

Many numeric entries do not have fields and, therefore, do not require a cursor. For example, when SYNTH FREQ is the currently selected menu, the display may appear as follows:



To enter a new frequency (e.g., 1544.1 kHz), type the number 1544.1 using the MENU keypad. As soon as the first digit is pressed, the previous display is blank; the new numbers appear as they are entered. Note that the previous setting (9.6) is still in effect until the **ENTER** key is pressed. The display then reads:

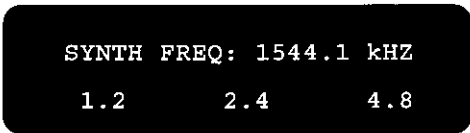

SYNTH FREQ

SYNTH FREQ

## Select a Synthesizer Frequency

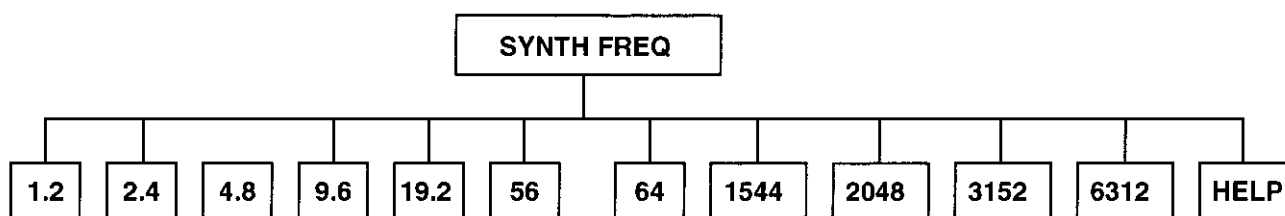

Figure 2-4  
SYNTH FREQ Menu

**Purpose:**

The SYNTH FREQ menu sets the frequency when using the FIREBERD 6000 built-in synthesizer. This menu is required when the FIREBERD is selected as the source of signal timing (i.e., the **GEN CLK** switch is set to the SYNTH position) and when the asynchronous or recovered timing modes are selected.

A synthesizer frequency can be selected from the set available in the menu (see Figure 2-4); however, any frequency can be specified using the MENU keypad. In such instances, frequencies are entered in kHz and must be within the range of .05 to 15000 kHz. When a frequency outside of this range is entered, the FIREBERD recognizes the entry as illegal and restores the previous setting without disrupting the test in progress. Please note that a newly specified frequency is not current until the **ENTER** key is pressed.

**Notes:**

1. A frequency may have four or five significant digits. If the first two digits are within the range of 16-99, four digits may be entered; if the first two digits are within the range of 10-15, five digits may be entered.
2. The range and format of any entered frequency is not checked until the **ENTER** key is pressed.
3. Auxiliary function 32 enables the user to program the MENU softkeys so that commonly used frequencies (other than the factory settings shown in Figure 2-4) are available as SYNTH FREQ menu selections. See Table 2-2 for a description of this capability.
4. When in asynchronous timing mode (i.e., the **TIMING MODE** switch is set to the ASYNC position), and the FIREBERD synthesizer is the source of signal timing, then the frequency specified can be no more than 20 kHz; in recovered timing mode, the frequency specified should be no more than 520 kHz.
5. When the jitter generator is enabled, the message **Synth defaults to xxx kHz with jit gen** appears in the MENU display. This means that any change in synthesizer frequency is ignored until the jitter generator is turned off or a new interface is selected.
6. When the HELP softkey is pressed, the message **Enter frequency in kHz: .05-15000** appears in the MENU display for approximately three seconds, or until another key is pressed.

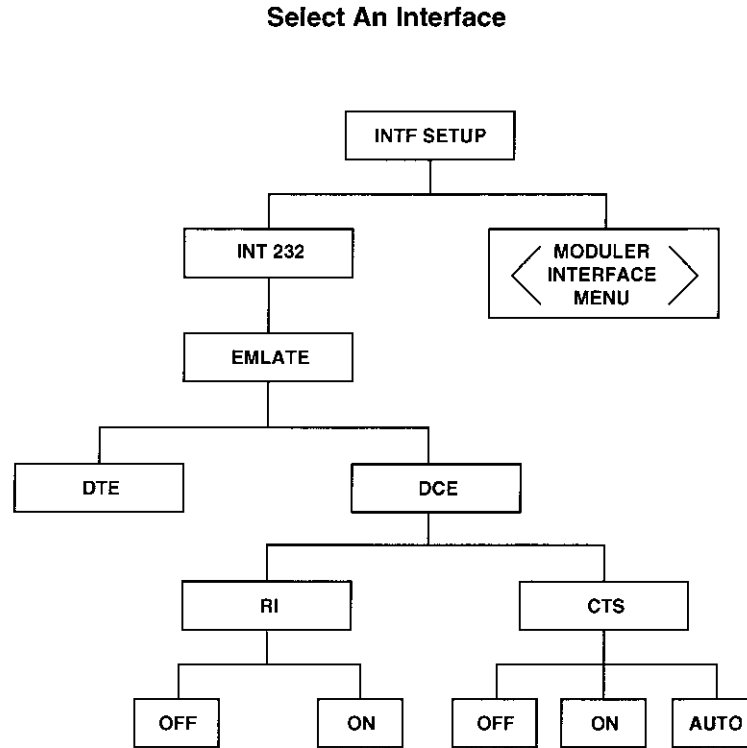

**Figure 2-5  
INTF SETUP Menu**

**Purpose:**

The INTF SETUP menu is used to select and configure either the internal RS-232 Interface or the modular interface installed in the rear panel of the FIREBERD 6000. This menu applies when running any FIREBERD 6000 test.

Since all interfaces have unique configuration requirements, no two interface menus are exactly the same. Thus, when the RS-232 Interface is selected, the user must configure the FIREBERD for DTE or DCE emulation by stepping through the menu shown in Figure 2-5. But if, for example, an installed T1 interface is selected, the menus offer entirely different configuration choices (e.g., framing, coding, etc.). See the appropriate manual for the menus that apply to your chosen modular interface.

**Notes:**

1. The internal RS-232 Interface is fully described in Section 1 of this manual and also lists the modular interfaces that are currently available for use with the FIREBERD 6000.
2. When no modular interface is installed in the rear panel of the FIREBERD 6000, the softkey label normally reserved for the installed interface is blank.
3. If the selected modular interface is removed, the word **EMPTY** is displayed in lieu of the interface name at the top of the menu.

TEST INTERVAL

TEST INTERVAL

## Select A Test Interval

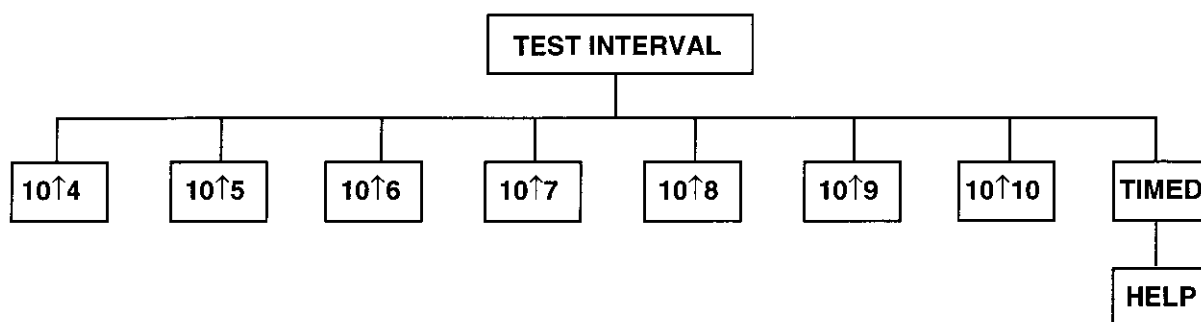

Figure 2-6  
TEST INTERVAL Menu

**Purpose:**

As its name suggests, the TEST INTERVAL menu is used to select a test interval. It applies when running any FIREBERD 6000 test.

The test interval can be set to a fixed bit length or a fixed time period (Figure 2-6). Fixed bit lengths of  $10^4$  through  $10^{10}$  can be selected using the appropriate softkey. When the TIMED softkey is pressed, a cursor can be used to specify a time interval within a 1 second to 24 hour range. When a value outside of this range is specified, the FIREBERD recognizes the entry as illegal and restores the previous value without disrupting the test in progress. Please note that a newly specified test interval is not valid until the ENTER key is pressed.

**Notes:**

1. When the **ANALYSIS MODE** switch is set to CONTINUOUS, the test interval determines the length of any measurement that is cyclical in nature (e.g., BER or BPV Rate); results that are not cyclical accumulate indefinitely. When the **ANALYSIS MODE** switch is set to SINGLE, the FIREBERD accumulates all results until the test interval has expired; at such time, the flashing message **Test Complete** appears in the ANALYSIS RESULTS display.
2. When the HELP softkey is pressed, the message **Enter time interval, 24 hr max, HH:MM:SS** appears in the MENU display for approximately three seconds, or until another key is pressed.

Set Asynchronous Character Format

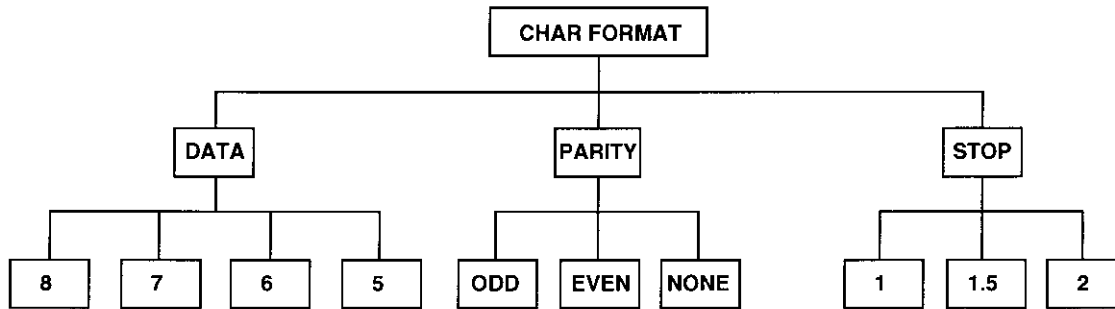

Figure 2-7  
CHAR FORMAT Menu

**Purpose:**

The CHAR FORMAT menu sets the asynchronous character format. It always applies when running an asynchronous test (i.e., when the **TIMING MODE** switch is set to the ASYNC position).

As shown in Figure 2-7, the CHAR FORMAT menu permits the configuration of data bits, parity bits, and stop bits. Using the appropriate softkeys, the user may select 5, 6, 7, or 8 data bits; odd, even, or no parity; and 1, 1.5, or 2 stop bits.



JITTER

JITTER

## Set Jitter Parameters And Display Spectral Analysis

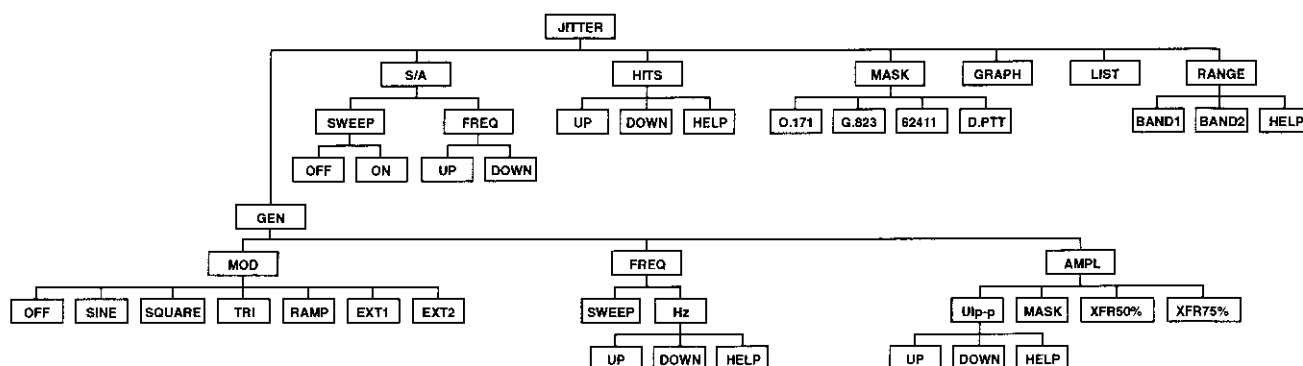

Figure 2-8  
T1 JITTER Menu

**Purpose:**

The JITTER menu, shown in Figure 2-8, is used to configure jitter parameters and display spectral analysis. This function is fully described in the Appendix section.

**Notes:**

1. The FIREBERD 6000 jitter capabilities are optional. When not installed, the message **Option not installed** appears in the MENU display for approximately three seconds, or until another key is pressed.
2. When the jitter option is installed, and a modular interface without such capability is selected, the message **Interface and jitter not compatible** appears in the MENU display for approximately three seconds, or until another key is pressed.
3. The FIREBERD 6000 also offers jitter testing for G.703 circuits and equipment. The menu for G.703 jitter is shown in the Appendix section.

Set Print Event Criteria

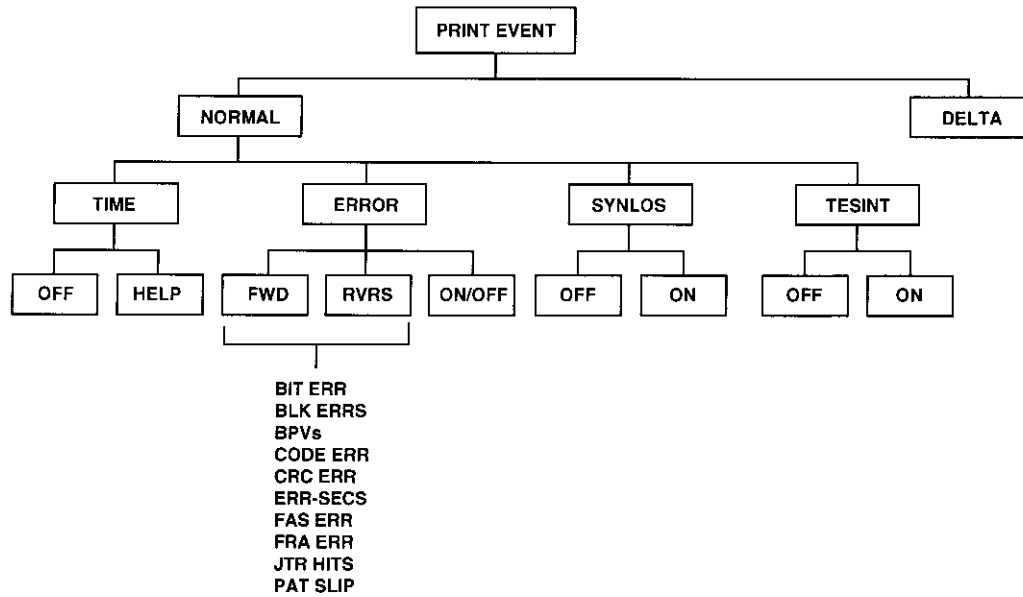

Figure 2-9  
PRINT EVENT Menu

**Purpose:**

The PRINT EVENT menu is used to specify the criteria for automatically sending test results to an external printer.

The PRINT EVENT menu can be set in two basic modes: DELTA and NORMAL (see Figure 2-9). When DELTA is selected, a Delta print is generated at the end of each test interval. A Delta print is a hard copy of those results accumulated during the most recent test interval, as opposed to those results that have accumulated since the start of the test. If the NORMAL softkey is pressed, cumulative results prints are offered based on one or more specific events: a time interval, an error, a synchronization loss, and a test interval.

The TIME softkey permits hard copy results to be printed at a time interval within the range 1 to 1440 minutes. The specific value is entered using the MENU keypad; the OFF softkey “turns off” time as a print criteria.

PRINT EVENT

PRINT EVENT

**Set Print Event Criteria  
(Continued)**

The ERROR softkey permits a hard copy of test results to be printed on the occurrence of one or more of the following errors:

- Bit errors (BIT ERRS)
- Block errors (BLK ERRS)
- Bipolar Violations (BPVs)
- Code errors (CODE ERR)
- CRC errors (CRC ERR)
- Bit Errors Over Non-Severely Errored Seconds (ERR-SES)
- FAS errors (FAS ERR)
- Frame errors (FRA ERR)
- Jitter hits (JTR HITS)
- Pattern slips (PAT SLIP)

The FWD softkey permits forward movement through the error menu shown above; the RVRS softkey permits backward movement; the current selection is shown in the upper left corner of the display. The ON/OFF key is used to select or reject an error as print criteria; the current setting is shown in the upper right corner of the display.

SYNLOS permits a printout to be generated when pattern synchronization is lost. In such instances, the test results that are sent to the printer are those accumulated from 2 to 4 seconds preceding the synchronization loss. The OFF and ON softkeys turn this print criteria off and on, respectively.

TESINT permits a printout to be generated at the end of the current test interval. The OFF and ON softkeys turn this print criteria off and on, respectively.

**NOTE:** The PRINTER **OFF/ON** switch must be turned ON for printing to occur. When this switch is ON, the LED in the switch illuminates.

## Store/Recall Test Configurations

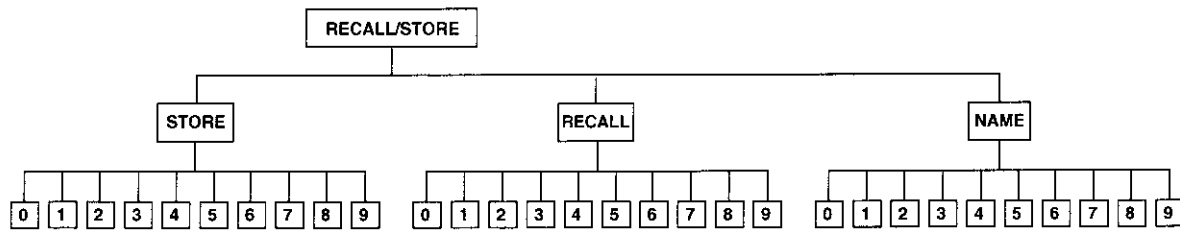

**Figure 2-10**  
**STORE/RECALL/NAME Menu**

**Purpose:**

The STORE/RECALL/NAME menu, shown in Figure 2-10, permits as many as 10 frequently used test configurations to be stored/named and recalled for future use. This feature saves set-up time by permitting all switch and interface selections for a specific test to be implemented by a single softkey.

For example, to name and store the current FIREBERD configuration, press the softkey below the NAME menu item and then press the softkey below the NUMBER menu item to select the desired number (0 to 9). Use the cursor keys to move the cursor position under the position of the character to be changed, then press the softkey below the UP or DOWN menu item to change the character at the cursor position. Continue using the cursor keys and softkeys to enter the four-digit name. After the name displayed is as desired, press the **ENTER** key to save the new name. Press the up arrow ( $\Delta$ ) key to display the STORE, RECALL, and NAME menu items. Press the softkey below the STORE menu item and then press the softkey below the desired number to store the FIREBERD configuration. (Press the **MORE** key to view additional menu choices.) When the configuration is stored, the top line displays: LAST PROGRAM followed by the stored program number and name. When desired, the saved configuration can be recalled by pressing the softkey below the RECALL menu item, followed by pressing the softkey for the desired configuration number.

**Notes:**

1. Any program ID number may also be entered using the keypad.
2. The Long User Patterns (USER1, USER2, USER3) are not stored and therefore cannot be recalled.

AUXILIARY

AUXILIARY

## Set Configurable Functions

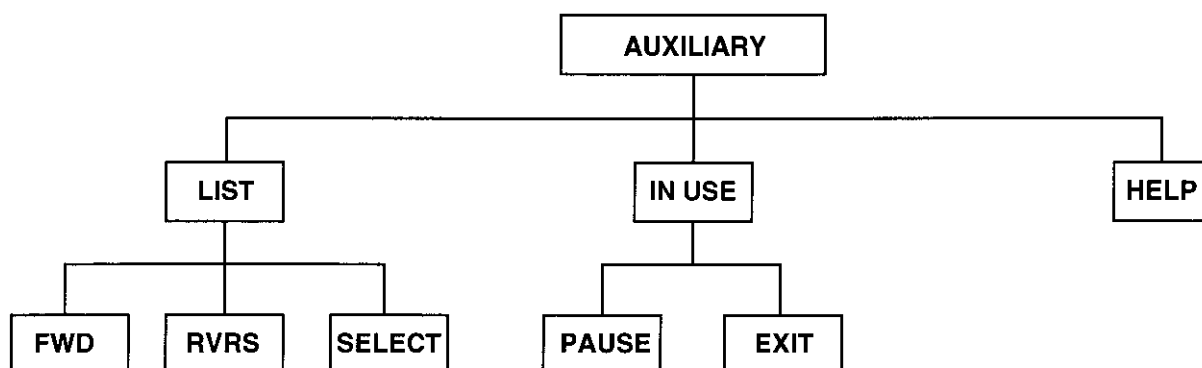

Figure 2-11  
AUXILIARY Menu

**Purpose:**

The AUXILIARY menu, shown in Figure 2-11, allows access to the following additional configurable functions.

<u>Aux Function:</u>	<u>Name:</u>
1	Generator clock polarity
2	Receiver clock polarity
3	Receiver action on synchronization loss
4	Single transmit
6	Generator data inversion
7	Receiver clock selection
8	Out-of-band flow control
9	In-band flow control
10	Synchronization loss threshold
11	I/O driver selection
12	Frame relay
30	Block length
31	Signal delay
32	Programmed synthesizer frequencies
33	Programmable patterns
34	Site identification
35	Results print content
36	Status print selection
37	Printout format
38	RS-232 print/control setup
39	IEEE-488 print/control setup
40	Software version display
41	User message selection
42	Pre-sync loss results
43	Clear non-volatile memory
44	Histogram set-up
45	Synch acquisition threshold
46	Async data timeout
60	Time/date setting
99	Reset auxiliary functions to default states

**Set Configurable Functions  
(Continued)**

The LIST softkey allows the user to display the name and number of each function in the auxiliary menu. When LIST is selected, the FWD softkey permits forward movement through the menu; RVRS permits backward movement; SELECT lets the user enter the currently displayed menu. Also note that any auxiliary function can be selected by entering its number on the MENU keypad and pressing the ENTER key.

**Status-Select Auxiliary Functions (1 to 10 and 12)**

As a group, auxiliary functions 1 to 10 and 12 are known as status-select auxiliary functions (Table 2-2). This means that the potential status of each of these functions is reflected in their respective softkey labels. In the following table, with the exception of auxiliary function 10 (where MED is the default), the setting listed first is the default. A status-select auxiliary function is in use when it is set to any status other than the default. In such instances, the AUX FUNC IN USE label is backlit. Additionally, the IN USE softkey displays those status-select auxiliary functions that are not set to their defaults.

**NOTE:** Status-select auxiliary functions are not applicable to all interfaces.

Table 2-3 describes non-status-select auxiliary functions.

**Table 2-2  
Status-Select Auxiliary Functions**

Function:	Number:	Name:	Description:
Generator Clock Polarity	01	GEN CLK POL	NORMAL - Generates clock data phasing per interface standard.  INVERT - Clock data phasing is the inverse of the interface standard.
Receiver Clock Polarity	02	RCVR CLK POL	AUTO - Receiver clock data phasing is automatically detected, corrected, and maintained while error analysis is in progress.  NORMAL - Clock data phasing is per interface standard.  INVERT - Clock data phasing is the inverse of the interface standard.
Receiver Action On Synchronization Loss	03	ACT SYN LOSS	CLEAR - Clears all results counters and restarts test when synchronization is reacquired.  HALT - Freezes all results for duration of synchronization loss. Test continues as soon as synchronization is reacquired.  CONT - Continue to accumulate error analysis results while the receiver attempts to resynchronize. (Valid in SYNC and RECOVD timing modes only.)

AUXILIARY

AUXILIARY

**Set Configurable Functions  
(Continued)**

**Table 2-2  
Status-Select Auxiliary Functions (continued)**

Function:	Number:	Name:	Description:
Single Transmit	04	SINGLE TRANS	<p>OFF - Transmits data continuously.</p> <p>ON - Transmits only one pattern or message each time the <b>RESTART</b> switch is pressed. Note that this function does not support user patterns in recovered mode, but does support them in sync mode.</p> <p>This auxiliary function is disabled in self-loop mode, and it is disabled for all Long User Patterns.</p>
Generator Data Inverter	06	GEN DATA INV	<p>OFF - Transmitted data not inverted.</p> <p>ON - Transmitted data inverted.</p>
Receiver Clock Select (DCE Emulation Only)	07	RCVR CLK SEL	<p>AUTO - ST (a DCE output) is automatically selected if TT (a DCE input) is not present in the interface.</p> <p>TT - TT selected.</p> <p>ST - ST selected.</p>
Out-of-Band Flow Control	08	OUT-BAND FLOW	<p>OFF - Data transmission occurs regardless of signaling lead status.</p> <p>ON - Data transmission is conditioned upon the reception of one or more of the following signaling leads: TR (DTR), DM (DSR), RS (RTS), CS (CTS), and RR (RLSD). CS is the default. This auxiliary function is disabled in self-loop mode.</p>
In-Band Flow Control	09	IN-BAND FLOW	<p>OFF - FIREBERD does not respond to XON and XOFF characters in the data received. (Asynchronous transmission is not affected.)</p> <p>ON - FIREBERD scans the incoming data for XON and XOFF characters and responds accordingly. XOFF halts the transmission of data and XON resumes the transmission of data. Defaults XON to 11H and XOFF to 13H.</p> <p>This auxiliary function applies to asynchronous USER and FOX messages only.</p>

**Set Configurable Functions  
(Continued)**

**Table 2-2  
Status-Select Auxiliary Functions (continued)**

Function:	Number:	Name:	Description:
Sync Loss Threshold	10	SYNC LOSS THR	<p>Thresholds for SYNC and RECOVD timing modes are:</p> <p>LOW - Declare sync loss when 100 bit errors are counted in less than 1000 bits.</p> <p>MED - Declare sync loss when 250 bit errors are counted in less than 1000 bits.</p> <p>HIGH - Declare sync loss when 20,000 bit errors are counted in less than 100,000 bits.</p> <p>The settings for ASYNC timing mode are:</p> <p>LOW and MED - Declare sync loss when 30 character errors are counted in less than 60 received characters.</p> <p>HIGH - Declare sync loss when 20,000 bit errors are counted in less than 100,000 bits.</p>
I/O Driver Select	11	I/O DRIVER SEL	<p>SELECT - Sets the FIREBERD for both printing and remote control in any combination of the following:</p> <p>Remote Control: 232, 488, None.</p> <p>Printing: 232, 488, Remote, None.</p>
Frame Relay	12	FRAME RELAY	<p>Disable (OFF) or enable (ON) the frame relay option. The frame relay option is supported by several data interfaces. Please refer to the frame relay appendix, at the back of this manual for more information on this option.</p>



AUXILIARY

AUXILIARY

**Set Configurable Functions  
(Continued)**

**Table 2-3  
Non-Status Select Auxiliary Functions**

Function:	Number:	Name:	Description:
Block Length	30	BLK LEN	Select the block length. The allowable range is 100 to 1,000,000 bits.
Signal Delay	31	DELAY	Set up the FIREBERD for signal delay timing. The start timing and stop timing signals and edges are selected with this function. See Section 2.8 for detailed information on setting up for delay timing.  <b>NOTE:</b> The start and stop parameters that reference signaling leads are only valid for interfaces that use these signals.
Program Common Frequencies	32	COMMON FREQUENCIES	Program the most commonly used frequencies as softkey settings for the SYNTH FREQ function of the <b>MENU</b> switch.
Programmable Pattern	33	PRGM PATTERN	Program and edit a 3- to 24-bit data pattern, to be used when the <b>DATA</b> switch is set to the PRGM position. The order of data bits transmitted is left-to-right on the display. When this auxiliary function is selected, the pattern editor is in "exchange" mode. This means that any binary digits entered overwrite the digit at the cursor. Use the INSERT softkey to toggle in/out of insert mode. In insert mode, digits are inserted at the cursor without overwriting any others. Digits may be entered at the end of the pattern in either mode. The DELETE softkey deletes the digit at the cursor. The > and < keys on the MENU keypad are used to position the cursor. The <b>ENTER</b> key is used to save and implement all changes made to the pattern. The A key causes the FIREBERD to return to the unedited version of the pattern.
Site Identification	34	SITE ID	Identify a site when the FIREBERD is used in a specific network. The site ID is entered by positioning the cursor under each "digit" (using the > and < keys on the MENU keypad) and using the UP or DOWN softkeys to select the desired ASCII character.

**Set Configurable Functions  
(Continued)**

**Table 2-3  
Non-Status Select Auxiliary Functions (Continued)**

Function:	Number:	Name:	Description:
Results Print	35	RESULTS PRINT	Determine the content of a results printout. STD selects the standard printout. The LONG print includes all applicable results. The CUSTOM print allows each result to be included (ON) or excluded (OFF). Note that each result is included in the printout only as long as it is applicable to the operating mode in use at the time of the printout.
Status Print Selection	36	STATUS PRINT	Enable (ON) or disable (OFF) the printing of individual status messages. When enabled, the status message is printed each time the status changes (if the printer is enabled, the LED is illuminated in the <b>OFF/ON</b> switch in the PRINTER block); when disabled, the LED in the <b>OFF/ON</b> switch is extinguished, the status message is not printed.
Printout Format	37	PRNT FRMT	Specify the printout format, as follows:  COLUMN - choose 20-, 40-, or 80-column printouts.  TERM - choose carriage return-linefeed (CRLF), carriage return (CR), linefeed (LF), or no (NONE) line termination.  MODE - choose SLOW (maximum 20 characters per second) or FAST print speed (full baud rate)
RS-232 Print Controller Interface Set-up	38	RS-232	Used to configure the RS-232 Printer/Remote Controller Interface. The display for this function appears as:  232: bbbb,d,pppp  where bbbb is the baud rate: 110, 300, 600, 1200, 2400, 4800, 9600.  d is the number of data bits: 7, 8.  pppp is the parity: ODD, EVEN, NONE.

AUXILIARY

AUXILIARY

**Set Configurable Functions  
(Continued)**

**Table 2-3  
Non-Status-Select Auxiliary Functions (Continued)**

Function:	Number:	Name:	Description:
IEEE-488 Address	39	IEEE-488	<p>View the current address of the IEEE-488 Printer/Remote Control Interface, as follows:</p> <p>488: ADDR: 20</p> <p>where 20 is the address of the controller (range: 0 to 31). Note that the controller is only addressable when auxiliary function 11 (I/O Driver Select) is used to specify IEEE-488 remote control; when IEEE-488 is specified for a printer, the message TALK appears in the display in lieu of an address.</p>
Software Version	40	SOFTWARE VERSION	<p>Display the current software version and the date the software was revised.</p> <p>SW Version: K (c) TTC DD/MM/YY</p>
User Message Selection	41	USER PATTERN	<p>Select from a series of patterns that are in addition to those available through the <b>DATA</b> switch: 1:7, 3-IN-24, T1-1 to T1-6, T1-DALY, T1-mW, 1020 Hz, and DDS-1 to DDS-6. Each pattern is described in detail earlier in this section (see the <b>DATA</b> switch description for additional pattern information).</p>
User Message Selection	41	USER MESSAGE	<p>Long User Patterns (LUPs) Auxiliary function 41 can also be used to enter or edit up to three patterns of up to 2048 characters each. Any of these patterns may be used when the <b>DATA</b> switch is set to the USER position. Characters are entered in hexadecimal format (0 to 9 and A to F) from the MENU keypad; the &gt; and &lt; keys are used to position the cursor. In the hexadecimal format, 2 digits are required to define a character; thus, the cursor is 2 digits wide.</p> <p>The INSERT softkey is used to insert characters without overwriting the existing ones. When not inserting, the characters entered overwrite the characters at the cursor. Characters may be added at the end of the user message in either case.</p> <p>The DELETE softkey deletes the character at the cursor.</p> <p>The display for this function is xxxxxxxxxxxxxx*yyyy where xx is the user message and yyyy is the numerical position of the byte underlined by the cursor.</p> <p>After creating a message or editing an existing one, press the <b>ENTER</b> key to save and implement it.</p>

**Set Configurable Functions  
(Continued)**

**Table 2-3  
Non-Status-Select Auxiliary Functions (continued)**

Function:	Number:	Name:	Description:
Recall Pre-Sync Loss Results	42	PRE SYNC LOSS	Transfer the test results recorded from 2 to 4 seconds before a synchronization or power loss to the results display buffer. In such instances, an automatic display hold is performed, and test results are automatically sent to a printer, if one is enabled. If no sync or power loss has occurred since the test started, the message <b>Pre sync/power loss results not available</b> is displayed.
Clear Non-Volatile RAM Settings	43	CLEAR NOV RAM	Clear the FIREBERD 6000 of its current settings for stored programs, patterns, and user messages. When selected, all settings are returned to their factory-set values. The user must verify this operation before it is actually performed.
Histogram Setup	44	HISTOGRAM	Select the results to be graphed and the scale to be used for histogram plots. See Section 3 for details on the histogram printout.
User Message Threshold Synchronization	45	USR SYN THR	Select the number of unerrored bytes within the user message that must be received before pattern synchronization is established. PATL specifies that the entire pattern length must be received unerrored to declare pattern synchronization. The BYTE selection is used to specify a variable number of unerrored bytes (between 10 to 2048 bytes) that must be received to declare pattern synchronization. This function only affects synchronous user messages.
Asynchronous Data Timeout	46	ASYNC TIMEOUT	Select the action taken when no data is received in asynchronous timing mode. ON forces a synchronization loss after 10 seconds have passed without receiving data; OFF does not force a sync loss under identical conditions.
Time/Date Set	60	TIME/DATE	Set the FIREBERD time and date calendar. The display shows:  HH:MM:00 DD/MM/YY  When changing either the data or time, position the cursor under the field to be changed and enter the correct number from the keypad. All or part of the time/date may be modified. The hours are in 24-hour format and range from 00 to 24. Setting the minutes automatically sets the seconds to 00. The <b>ENTER</b> key implements the setting.

AUXILIARY

AUXILIARY

**Set Configurable Functions  
(Continued)****Table 2-3  
Non-Status-Select Auxiliary Functions (continued)**

Function:	Number:	Name:	Description:
Clear Status	99	CLEAR FUNC IN USE	Reset the status-select auxiliary functions (1 to 10) to their factory-set (i.e., default) states. When selected, the AUX FUNC IN USE panel label is no longer backlit.

MK

MK

Mark Indicator

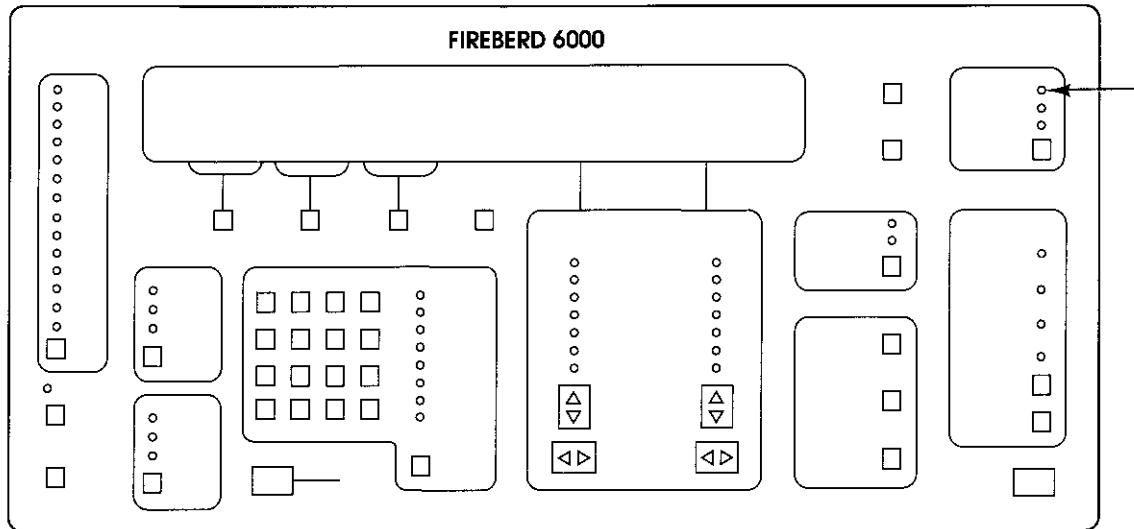

Front-Panel Component-Type:

Panel label with backlighting.

Purpose:

The MK indicator illuminates when a Mark (i.e., one) is detected in the received data.

Notes:

1. Although not always apparent to the human eye, the MK and SP indicators illuminate at different times (i.e., the SP indicator is off when a Mark is detected and vice versa).

NO CLK

NO CLK

## No Receiver Clock Indicator

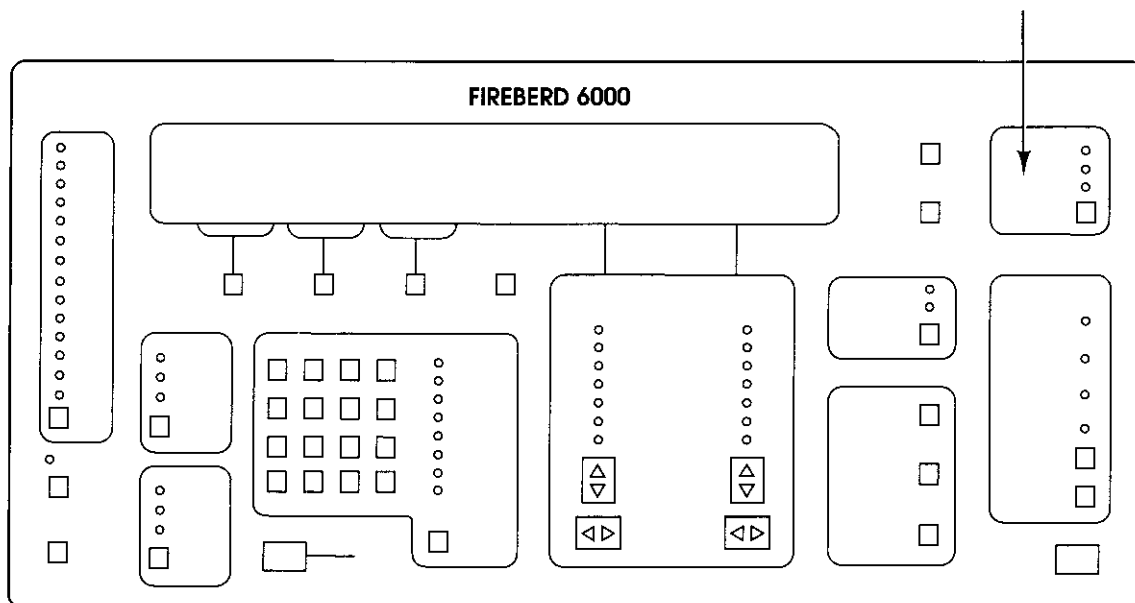
**Front-Panel Component-Type:**

Panel label with backlighting.

**Purpose:**

The NO CLK label is backlit when the selected timing mode requires a clock and there has been no receiver clock activity for 50 milliseconds.

**Notes:**

1. A clock loss also forces frame and pattern synchronization loss.

*Instrument Description*

**POWER**

**POWER**

**Turn the FIREBERD 6000 On or Off**

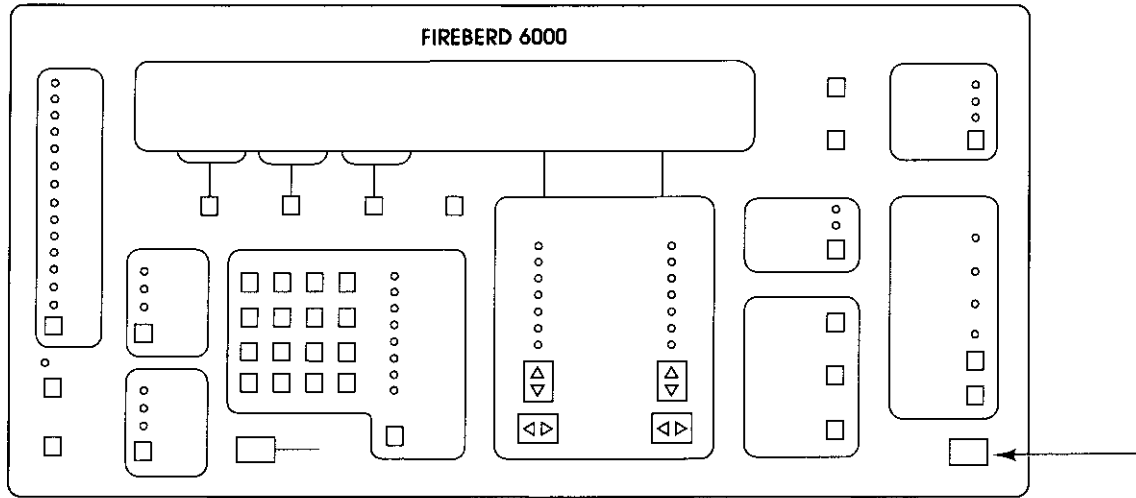

**Front-Panel Component-Type:**

Single-function switch.

**Purpose:**

The **POWER** switch turns the FIREBERD 6000 on or off. The OFF and ON positions are displayed to the left of the switch.



PRINTER

PRINTER

## Printer Control Block

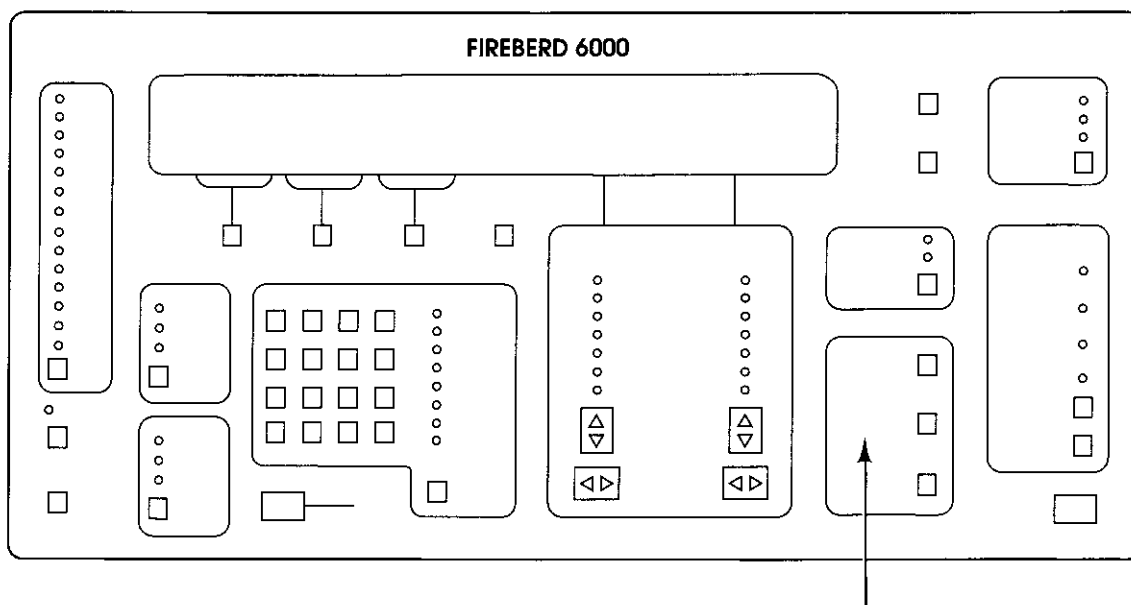
**Front-Panel Component-Type:**

Single-function switches.

**Purpose:**

PRINTER is a block of three switches that controls any printer attached to the FIREBERD 6000.

Select:	To:
OFF/ON	Enable automatic printouts based on a specific event (e.g., a time interval or a bit error). An event is selected using the PRINTEVENT section of the MENU switch. See the PRINT EVENT description (part of the MENU discussion) found earlier in this section for a complete description of all print event choices.
RESULTS	Obtain a copy of the most recent test results.
CONTROLS	Obtain a printout of the current test configuration.

**Notes:**

1. When the **DISPLAY HOLD** switch is enabled, the FIREBERD 6000 prints the current results rather than the values that are frozen in the display (i.e., the **RESULTS PRINT** switch is not affected by DISPLAY HOLD).
2. The print buffer is always cleared when the **OFF/ON** switch is placed OFF (the LED in this switch is extinguished) from the ON position.
3. Results and controls printouts can be obtained when the LED in the PRINTER **OFF/ON** switch is OFF (the LED is extinguished) by pressing the **RESULTS** or **CONTROLS** switch.
4. The LED in the **OFF/ON** switch illuminates when in the ON position.

RESTART

RESTART

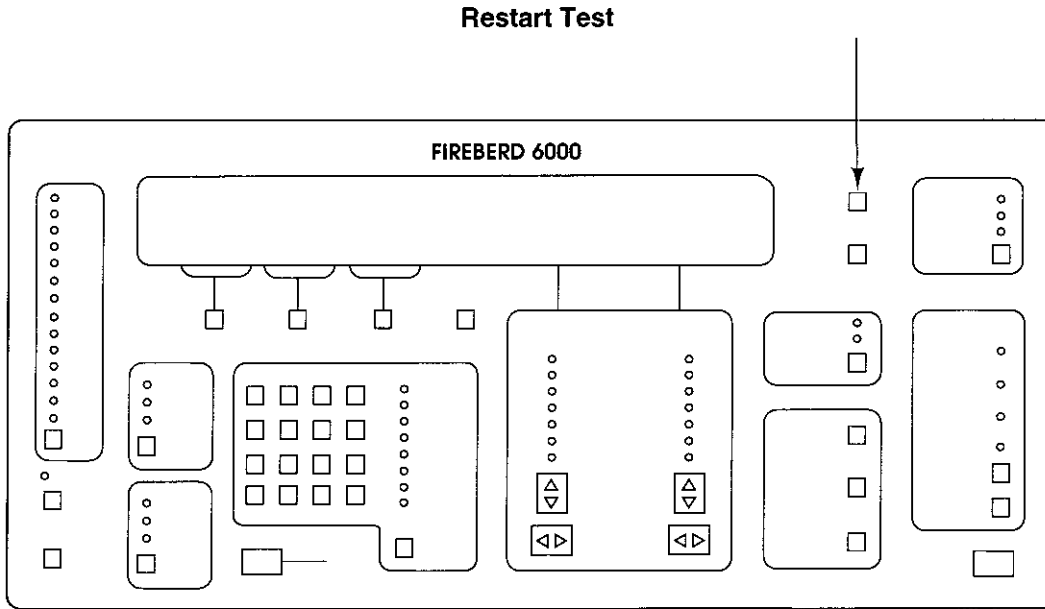

**Front-Panel Component-Type:**

Single-function switch.

**Purpose:**

The **RESTART** switch clears all accumulated analysis results; all tests and measurements are restarted.

**Notes:**

1. Pressing the **RESTART** switch also initiates data transmission in the Single Transmit mode, selected through auxiliary function 04.
2. Some of the more common events that cause an automatic test restart are:
  - a) Changing the data pattern.
  - b) Changing the source of transmit timing.
  - c) Changing the synthesizer frequency.
  - d) Changing the **ANALYSIS MODE** selection.
  - e) Changing the interface selection.
  - f) Changing the **GEN CLK** selection.
  - g) Changing the **TIMING MODE** selection.
  - h) Changing the TEST INTERVAL category selection.
  - i) Changing the CHARACTER FORMAT category selection.
  - j) Changing certain auxiliary functions.

(RL) LED INDICATOR

(RL) LED INDICATOR

## Remote Loopback (RL) Indicator

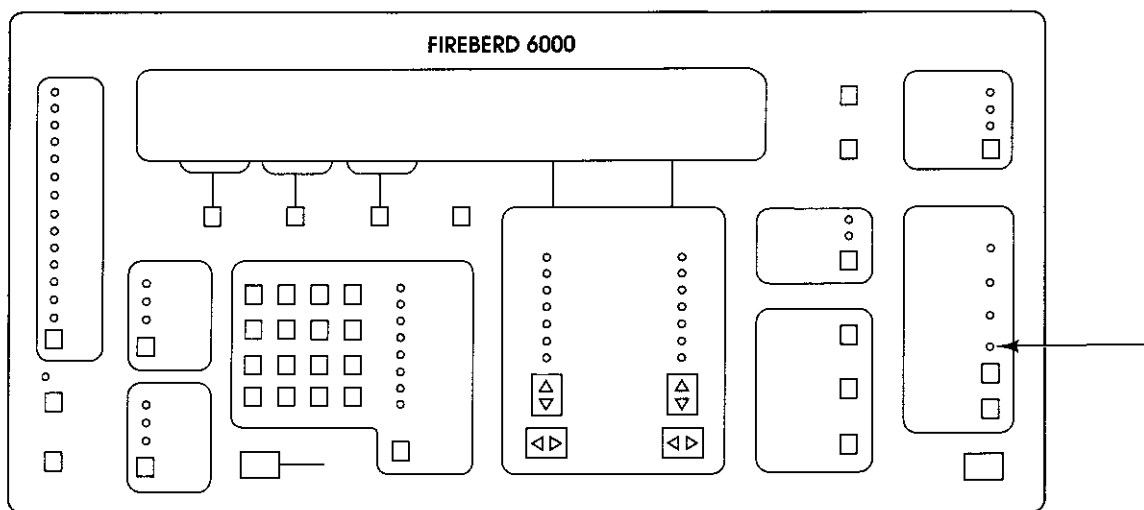
**Front-Panel Component-Type:**

Discrete LED indicator with adjacent label.

**Purpose:**

When a data interface, such as RS-232, V.35, or RS-449 is selected, and the FIREBERD 6000 is emulating a DCE, the (RL) LED indicator shows the state of the Remote Loopback (RL) line. When the indicator is illuminated, the RL line is enabled; otherwise, the RL line is disabled.

**Instrument Description**

**RLSD (RR) LED INDICATOR**

**RLSD (RR) LED INDICATOR**

**Receive Ready (RR) Indicator**

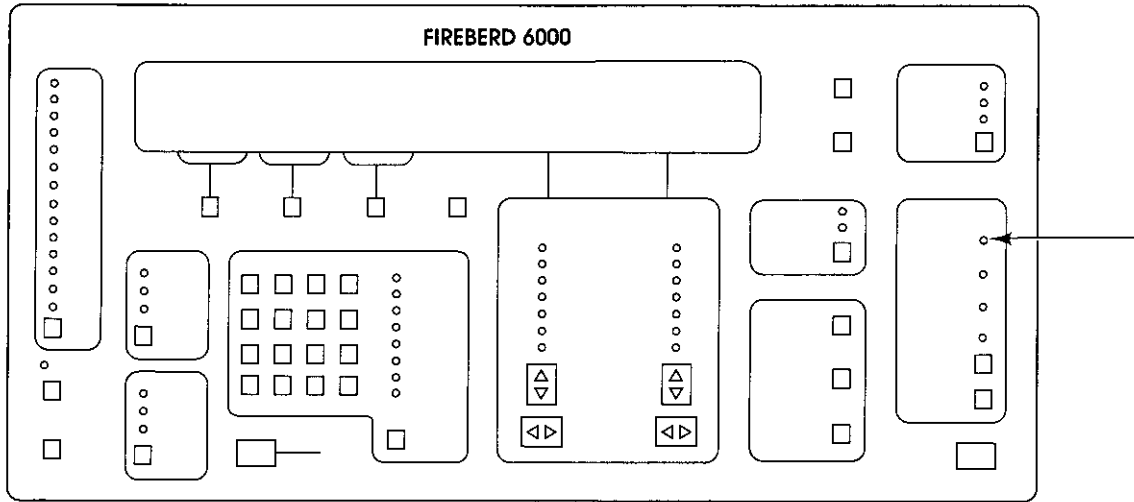

**Front-Panel Component-Type:**

Discrete LED indicator with adjacent label.

**Purpose:**

When a data interface, such as RS-232, V.35, or RS-449 is selected, and the FIREBERD 6000 is emulating a DTE, the RLSD (RR) indicator illuminates when the connecting DCE has enabled the Receive Ready (RR) line. When the RLSD (RR) indicator is not illuminated, the DCE RR line is disabled.

RLSD (RR) SWITCH

RLSD (RR) SWITCH

## Receive Ready (RR) Line Control

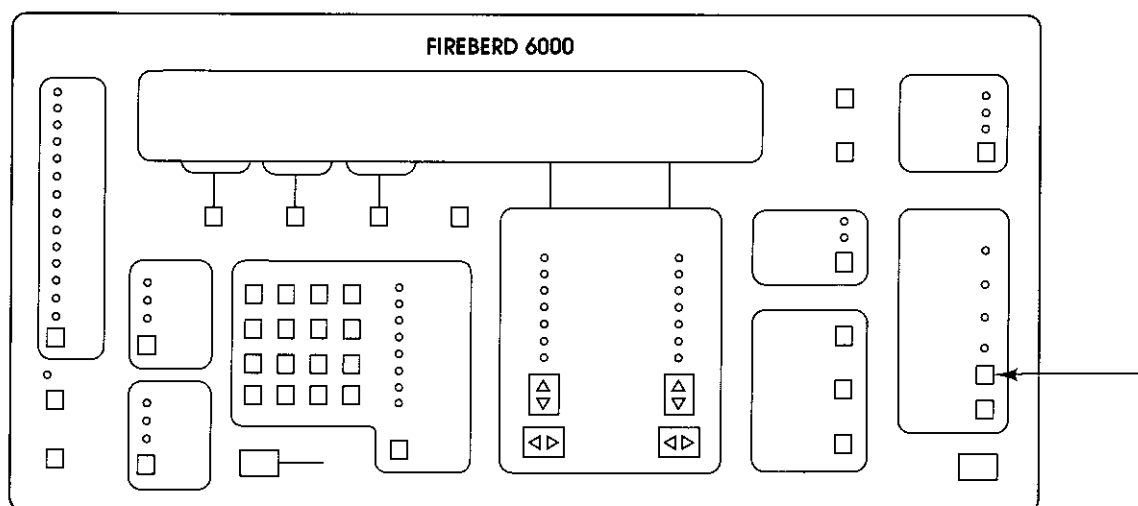
**Front-Panel Component-Type:**

Single-function switch.

**Purpose:**

When a data interface such as RS-232, V.35, or RS-449 is selected, and the FIREBERD 6000 is emulating a DCE, the **RLSD (RR)** switch controls the state of the Receive Ready (RR) line. When the switch is illuminated, the RR line is enabled; otherwise, the RR line is disabled.

**Notes:**

1. The enabling of signaling leads is an activity normally associated with out-of-band flow control. In out-of-band flow control, data transmission takes place only when certain signaling leads are placed in the ON state (i.e., enabled). In either DTE or DCE emulation, data transmission may be conditioned upon the enabling of any or all of these leads:

<u>Signaling Lead:</u>	<u>Described on Page:</u>
CTS	2-34
DSR (DM)	2-42
DTR (TR)	2-44
RLSD (RR)	2-82
RTS	2-84

2. Auxiliary function 08 (OUT-BAND FLOW) allows the user to specify which signaling leads must be in the ON state for data transmission to take place.

**Instrument Description**

**RTS LED INDICATOR**

**RTS LED INDICATOR**

**Request To Send (RTS) Indicator**

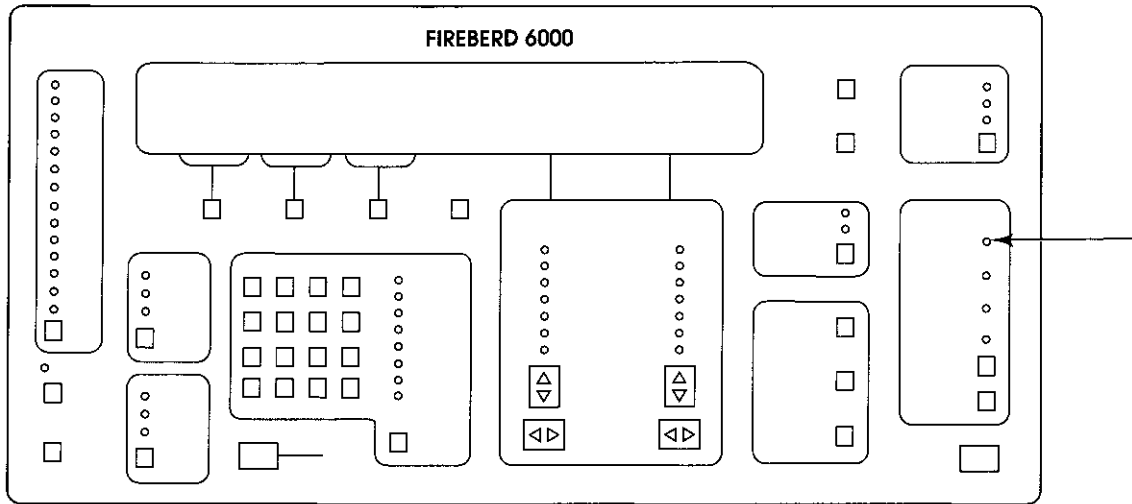

**Front-Panel Component-Type:**

Discrete LED indicator with adjacent label.

**Purpose:**

When a data interface, such as RS-232, V.35, or RS-449 is selected, and the FIREBERD 6000 is emulating a DCE, the RTS indicator illuminates when the connecting DTE has enabled the Request To Send (RTS) line. When the RTS indicator is not illuminated, the RTS line is disabled.

RTS SWITCH

RTS SWITCH

## Request To Send (RTS) Line Control

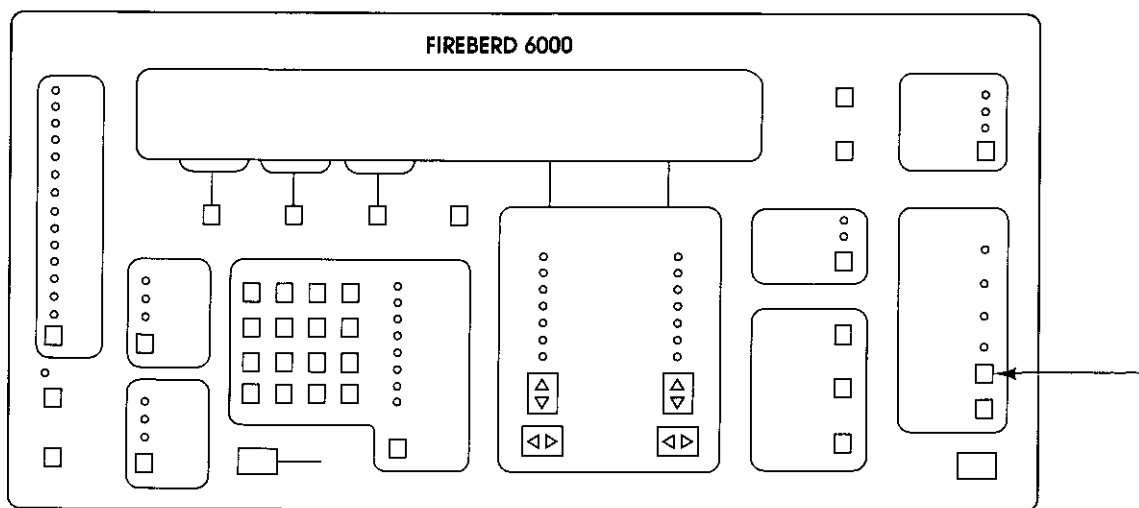
**Front-Panel Component-Type:**

Single-function switch.

**Purpose:**

When a data interface, such as RS-232, V.35, or RS-449 is selected, and the FIREBERD 6000 is emulating a DTE, the **RTS** switch controls the state of the Request To Send (RTS) line. When the switch is illuminated, the RTS line is enabled; otherwise, the RTS line is disabled.

**Notes:**

1. The enabling of signaling leads is an activity normally associated with out-of-band flow control. In out-of-band flow control, data transmission takes place only when certain signaling leads are placed in the ON state (i.e., enabled). In either DTE or DCE emulation, data transmission may be conditioned upon the enabling of any or all of these leads:

<u>Signaling Lead:</u>	<u>Described on Page:</u>
CTS	2-34
DSR (DM)	2-42
DTR (TR)	2-44
RLSD (RR)	2-82
RTS	2-84

2. Auxiliary function 08 (OUT-BAND FLOW) allows the user to specify which signaling leads must be in the ON state for data transmission to take place.

SELF LOOP

SELF LOOP

Enter/Exit Self-Loop Mode

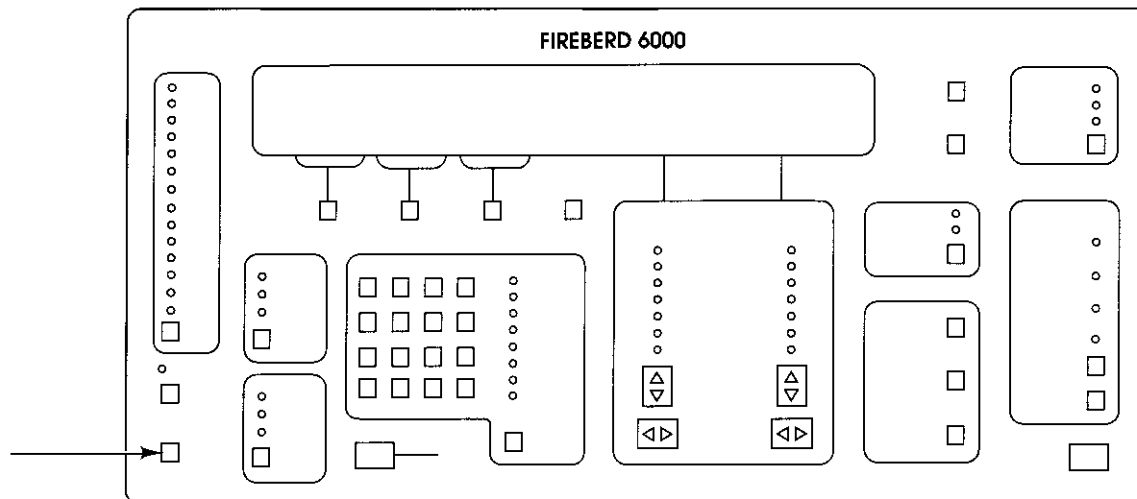

**Front-Panel Component-Type:**

Single-function switch.

**Purpose:**

The **SELF LOOP** switch changes the FIREBERD 6000 mode of operation from full-duplex to self-loop or vice versa. In self-loop mode, the instrument's transmit data and clock leads are connected to the receive data and clock leads, establishing an internal loop for testing the FIREBERD and its selected interface. Additionally, self-loop mode permits the user to disconnect the FIREBERD from the circuit under test without removing cables from the interface.

**Notes:**

1. When the FIREBERD 6000 is in self-loop mode, the red LED within the **SELF LOOP** switch is illuminated. To return to full-duplex mode, press and immediately release the switch.
2. Out-of-band flow control (controlled in auxiliary function 8) and single transmit mode (controlled in auxiliary function 4) are disabled in self-loop mode.

To verify operation of the FIREBERD and the selected interface, the user can select self-loop operation (via the **SELF LOOP** switch). In self-loop operation, the FIREBERD transmit data and clock leads are connected to the receive data and clock leads, establishing an internal loop for testing the FIREBERD and its selected interface. Self-loop isolates the clock and data drivers and receivers from the interface connector; as a result, the user can disconnect the FIREBERD without removing cables from the interface. In this mode, both incoming and outgoing signaling lines remain active and connected to the system under test.

Self-loop operation is used to verify proper instrument setup and to check the operation of the installed data interface at the specified data rate. Data is continuously transmitted and received regardless of out-of-band flow control or the setting of the Single Transmit auxiliary function. Additionally, both in-band and out-of-band flow control are disabled so that data generation is performed unconditionally. Note that self-loop operation does not cause interface signaling leads to be looped. Additionally, all available error analysis results are exactly the same as during normal operation.



SP

SP

## Space Indicator

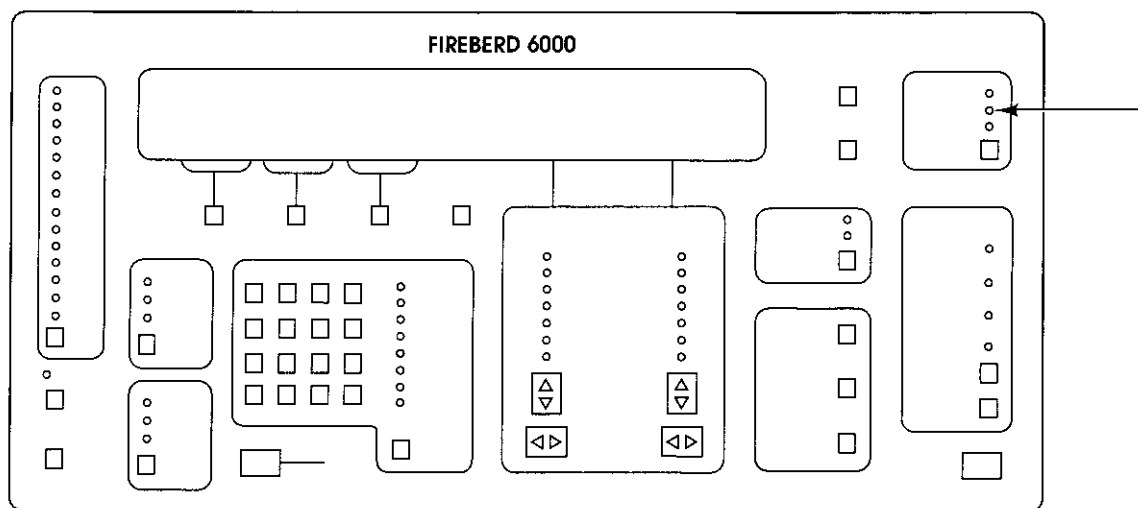
**Front-Panel Component-Type:**

Discrete LED with adjacent label.

**Purpose:**

The SP indicator illuminates when a Space (i.e., zero) is detected in the received data.

**Notes:**

1. Although not always apparent to the naked eye, the MK and SP indicators illuminate at different times (i.e., the SP indicator is off when a Mark is detected and vice versa).

SYNC

SYNC

Pattern Synchronization Indicator

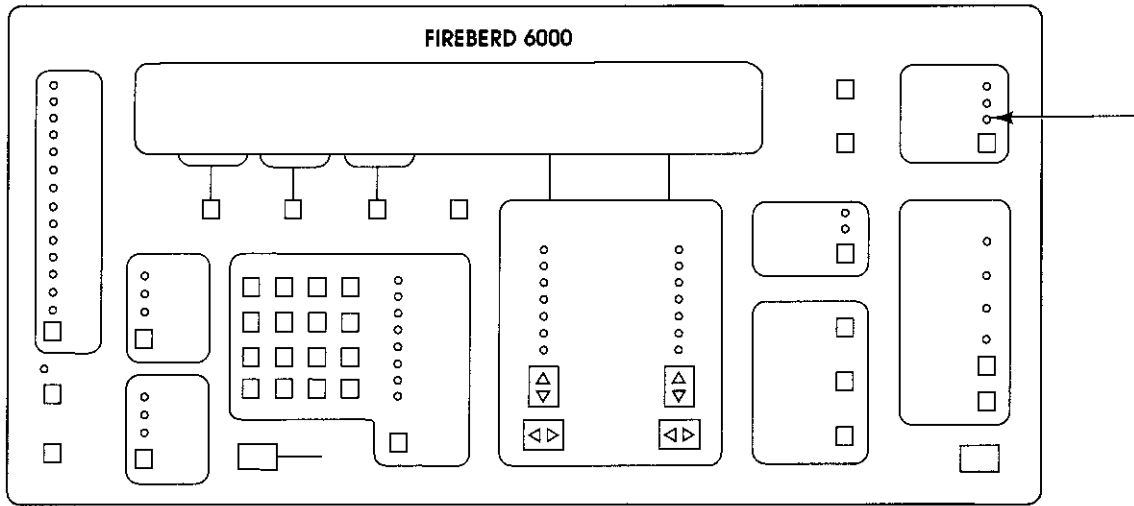

**Front-Panel Component-Type:**

Discrete LED indicator with adjacent label.

**Purpose:**

When conducting an out-of-service test, the SYNC indicator illuminates when the FIREBERD 6000 receiver achieves pattern synchronization. When monitoring live data, this indicator illuminates to show that a signal is present.

**Notes:**

1. The SYNC indicator is controlled by the receiver synchronization criteria described later in this section.

In standard results mode, error analysis begins when the receiver has successfully synchronized to the received data (as indicated by the illuminated SYNC LED). The following sections describe how synchronization is acquired, and how standard test results are affected by a loss of synchronization.

**Sync Acquisition**

The FIREBERD uses its autopolarity and receiver circuits to acquire synchronization automatically. The autopolarity circuit automatically corrects any data inversion that occurs in the system under test, and the receiver circuits synchronize to and detect any errors that occur in the received data stream. Note that autopolarity is not available with patterns that require Long User Pattern capability (see the DATA discussion in this section to determine which are long user patterns).

The setting of the **DATA** switch determines the data pattern that is expected by the receiver. Under normal operating conditions, the receiver does not momentarily declare synchronization to any pattern other than the current selection, even in a high bit-error-rate environment.

SYNC

SYNC

### Pattern Synchronization Indicator (Continued)

When synchronous timing or recovered timing is selected, the FIREBERD receiver declares synchronization to fixed pattern data (e.g., Mark, 1:1, 3-in-24, etc.) when it has received 30 consecutive bits without errors. For pseudorandom patterns, synchronization is declared upon receipt of  $30 + n$  consecutive error-free bits for a pattern length of  $2^n - 1$  (for the QRSS pattern,  $n=20$ ). For messages using synchronous timing, synchronization is dependent on auxiliary function 45 (USR SYN THR, described earlier in this section).

#### Synchronization Loss

The FIREBERD 6000 receiver declares a loss of synchronization upon the occurrence of these events:

1. A high error rate in the received data. In synchronous and recovered timing, synchronization is typically lost when 250 bit errors are counted in less than 1000 bits of data. Auxiliary function 10 (Sync Loss Threshold) may be used to decrease this threshold to 100 errors in less than 1000 bits or to increase it to 20,000 errors in less than 100,000 bits. In asynchronous operation, synchronization is lost when 30 errored characters are received in 60 or fewer characters of data.
2. Loss of received data. In synchronous and recovered timing, a data loss is declared when data that is clocked into the receiver does not change state for 63 bit periods. (The data loss detector is automatically disabled upon the selection of Mark data, as well as for fixed patterns of all Marks or all Spaces.) In asynchronous timing, a loss of received data is declared when no characters have been received for 10 seconds. When the FIREBERD 6000 loses synchronization as a direct result of a data loss, the DATLOSS count is incremented. When a printer is connected to the FIREBERD, "DATA LOSS XXX" is printed on the occurrence of each data loss (if the PRINTER OFF/ON switch is ON and DATA LOSS status messages are enabled). "DATA LOSS XXX" immediately precedes the SYNC LOSS printout, where XXX represents the count of data losses since the beginning of the test.
3. Loss of received clock. In synchronous timing, a clock loss is declared during the absence of high-to-low state transitions on the received clock line for a period greater than 50 milliseconds. When the FIREBERD loses synchronization as a direct result of a clock loss, the CLK LOSS count is incremented. When a printer is connected to the FIREBERD, "CLOCK LOSS XXX" is printed on the occurrence of each clock loss (if the OFF/ON switch is ON and CLOCK LOSS status messages are enabled). "CLOCK LOSS XXX" immediately precedes the SYNC LOSS printout when a printer is enabled, where XXX represents the count of clock losses since the beginning of the test.

When a synchronization loss occurs, the SYNCLOST indicator is illuminated, and remains so (even if synchronization is restored) until it is manually reset or the test is manually restarted. As such, SYNCLOST serves to signal the loss of receiver synchronization during the test.

When a printer is connected to the FIREBERD, "SYNC LOSS XXX" is printed on the occurrence of each synchronization loss (if the PRINTER OFF/ON switch is ON and SYNC LOSS status messages are enabled), where XXX represents the number of synchronization losses since the start of the test. Note that data losses, clock losses, and sync losses are numbered independently even though data losses and clock losses always cause a loss of synchronization.

#### Pre-Synchronization Loss Results

The FIREBERD allows the user to recall the set of test results that were in effect immediately preceding the most recent synchronization loss. In standard results mode, this activity is affected by auxiliary function 42 (Pre-Sync Loss Results), which causes a complete set of results preceding the most recent sync loss to be presented in the display. Auxiliary function 42 also initiates an automatic display hold, which permits scrolling through the pre-sync loss results. The current results may be displayed at any time by pressing the DISPLAY HOLD switch. If the PRINTER OFF/ON switch is ON, auxiliary function 42 also initiates a titled printout of these results, and includes the time at which they were stored.

**SYNC**

**SYNC**

**Pattern Synchronization Indicator  
(Continued)**

Auxiliary function 42 also allows access to the test results immediately preceding a loss of AC line power. Since a common results buffer is shared between pre-sync-loss and pre-power-loss results, the auxiliary function only gives the user access to the results preceding the most recent sync loss or the most recent power loss, whichever occurred last. Pre-sync-loss results are cleared when a test is manually restarted. Activation of the auxiliary function before a sync loss or power failure occurs causes the message **Pre sync/power loss results not available** to appear in the MENU display.

When a printer is enabled, the FIREBERD can provide a hard copy of the results preceding a sync or power loss. This activity is controlled by the PRINT EVENT portion of the **MENU** switch, described earlier in this section.

**Resynchronization**

Under normal circumstances, the FIREBERD immediately attempts to resynchronize when synchronization to incoming data is lost. Auxiliary function 03 (Receiver Action Upon Sync Loss) allows the user to choose what happens to the test results accumulated when a sync loss occurs. The auxiliary function offers three choices: CLEAR, HALT, and CONTINUE.

When CLEAR (the default setting) is selected, a sync loss causes all test results (except Performance results) to be cleared when synchronization is reacquired; the test is automatically restarted.

When HALT is selected, all test results are suspended until sync is reacquired. Note that when the test interval is a specific number of received data bits, sync losses affect the real-time duration in which the bits occur. This is because the accumulation of all analysis results, including the bit count, is suspended during a sync loss. Thus, in effect, the test interval is specified as the number of received data bits on which error analysis was actually performed. Timed test intervals are not affected by sync losses.

When CONTINUE is selected, test results continue to accumulate while the receiver is trying to resynchronize. In this mode, errors are counted at a BER of approximately 0.5. CONTINUE is not valid when asynchronous timing is selected.

SYNC LOST

SYNC LOST

## Detect Synchronization Loss

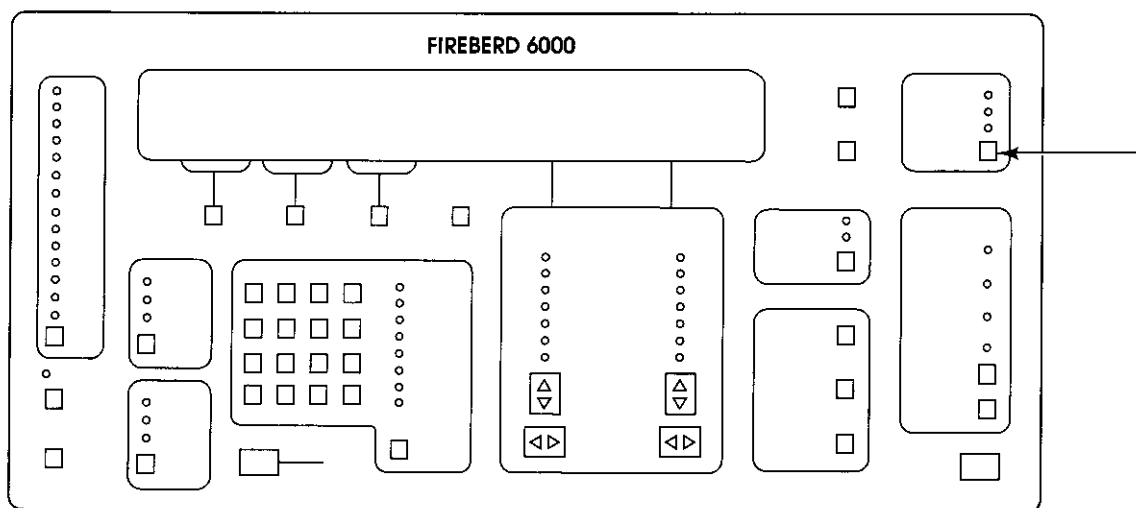
**Front-Panel Component-Type:**

Single-function switch.

**Purpose:**

The **SYNC LOST** switch indicates a loss of synchronization by the receiver.

**Notes:**

1. When a synchronization loss is detected, the **SYNC LOST** switch immediately illuminates and remains so even if synchronization is reacquired. By remaining illuminated, the switch acts as a history indicator that signals the occurrence of a synchronization loss sometime during the test. The switch remains illuminated until it is pressed or the test is restarted.

**Synchronization Loss**

The FIREBERD 6000 receiver declares a loss of synchronization upon the occurrence of these events:

1. A high error rate in the received data. In synchronous timing and recovered timing, synchronization is typically lost when 250 bit errors are counted in less than 1000 bits of data. Auxiliary function 10 (Sync Loss Threshold) may be used to decrease this threshold to 100 errors in less than 1000 bits or to increase it to 20,000 errors in less than 100,000 bits. In asynchronous operation, synchronization is lost when 30 errored characters are received in 60 or fewer characters of data.
2. Loss of received data. In synchronous timing and recovered timing, a data loss is declared when data that is clocked into the receiver does not change state for 63 bit periods. (The data loss detector is automatically disabled upon the selection of Mark data, as well as for fixed patterns of all Marks or all Spaces.) In asynchronous timing, a loss of received data is declared when no characters have been received for 10 seconds. When the FIREBERD 6000 loses synchronization as a direct result of a data loss, the DAT LOSS count is incremented. When a printer is connected to the FIREBERD, "DATA LOSS XXX" is printed on the occurrence of each data loss (if the PRINTER **OFF/ON** switch is ON and DATA LOSS status messages are enabled). "DATA LOSS XXX" immediately precedes the SYNCLOSS printout, where XXX represents the count of data losses since the beginning of the test.

**SYNC LOST**

**SYNC LOST**

**Detect Synchronization Loss  
(Continued)**

3. Loss of received clock. In synchronous timing, a clock loss is declared during the absence of high-to-low state transitions on the received clock line for a period greater than 50 milliseconds. When the FIREBERD loses synchronization as a direct result of a clock loss, the CLK LOSS count is incremented. When a printer is connected to the FIREBERD, "CLOCK LOSS XXX" is printed on the occurrence of each clock loss (if the PRINTER **OFF/ON** switch is ON and CLOCK LOSS status messages are enabled). "CLOCK LOSS XXX" immediately precedes the SYNC LOSS printout when a printer is enabled, where XXX represents the count of clock losses since the beginning of the test.

When a synchronization loss occurs, the SYNCLOST indicator is illuminated, and remains so (even if synchronization is restored) until it is manually reset or the test is manually restarted. As such, SYNCLOST serves to signal the loss of receiver synchronization during the test.

When a printer is connected to the FIREBERD, "SYNC LOSS XXX" is printed on the occurrence of each synchronization loss (if the PRINTER **OFF/ON** switch is ON and SYNC LOSS status messages are enabled), where XXX represents the number of synchronization losses since the start of the test. Note that data losses, clock losses, and sync losses are numbered independently even though data losses and clock losses always cause a loss of synchronization.

TIMING MODE

TIMING MODE

Select a Mode of Signal Timing

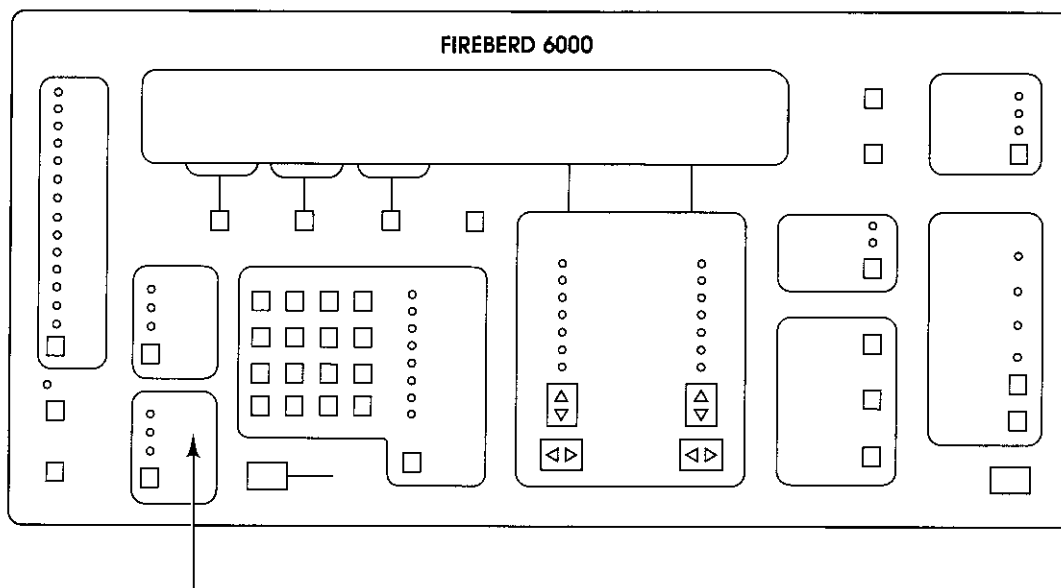

Front-Panel Component-Type:

Multifunction switch.

Purpose:

The **TIMING MODE** switch controls the type of transmit and receive timing required for any out-of-service test.

Select:	To:
SYNC	Choose synchronous timing. In synchronous transmission, the time interval between data bits is fixed and based on a controlled clock rate. To provide the required timing information to the receiving equipment, the clock signal is transmitted with the data (on a separate lead).
ASYNC	Choose asynchronous timing. In asynchronous transmission, the data is divided into characters containing 5 to 8 bits each. Each character is "framed" with start and stop bits, and may also include a parity bit. No clock signal accompanies the data.
RECOVD	Choose recovered timing. In this mode, the receiver achieves bit synchronization from the transitions in the data stream. If present, the receive clock is ignored.

**NOTE:** The Clock Recovery Option (Option 6004) is required to recover timing from synchronous signals to 520 kb/s.

**Timing Mode Selections**

The FIREBERD 6000 offers four timing selections: synchronous, asynchronous, recovered, and pseudoternary.

**Select a Mode of Signal Timing  
(Continued)**

Synchronous operation requires both a data and a clock signal. Asynchronous operation only requires a data signal, but several parameters must be coordinated between the transmit and receive units (i.e., baud rate, number of bits, parity, etc.). Recovered operation is similar to synchronous operation except that the received clock (if any) is ignored and a clock is derived from the data. Pseudoternary operation has the clock and data encoded in the same signal; however, the bit rates are restricted to certain frequencies and interfaces.

With the exception of pseudoternary operation, timing is selected by the **TIMING MODE** switch. When a pseudoternary interface is selected, the **TIMING MODE** switch is disabled. All timing modes are described in detail in the following sections.

**Synchronous Timing and Operation**

When synchronous timing is selected, the FIREBERD operates as a standard DTE or DCE, with several features which provide additional flexibility for testing. The data is a stream of bits accompanied by a synchronous clock.

The FIREBERD provides data and a synchronous clock based on the generator clock source selected. The **GEN CLK** switch allows one of three clock sources to be chosen: the synthesizer (SYNTH), the interface (INTF), or a user-provided clock source (BNC). The INTF setting uses a clock source from the data interface module. When the FIREBERD is emulating a DTE, this interface clock is usually sourced from the remote unit; when emulating a DCE, the receiver clock is used as the clock source.

The FIREBERD receiver requires data and a clock which is synchronized to that data. When the clock is not synchronized to the data, clock slips and/or clock-data phase changes may occur. The FIREBERD automatically selects a receiver clock appropriate for the timing mode and the interface selected. When emulating a DCE, the TT (Transmit Timing) signal is normally used; if TT is not active, ST (Send Timing) is automatically selected. Auxiliary function 07 can be used to override this feature.

**Asynchronous Timing and Operation**

Asynchronous timing allows generation and error analysis of character data. Using the frequency synthesizer, any baud rate from 50 b/s to 20 kb/s may be selected. Split frequency operation is also allowed when a customer-provided external reference is used.

To generate asynchronous data, the **GEN CLK** switch must be set to either the SYNTH or the BNC position. When set to the SYNTH position, the baud rate of the data must be entered as the synthesizer frequency. When set to the BNC position, a clock at 16 times the desired generator baud rate must be provided at the GEN CLK IN BNC input. In all cases where receiver operation is necessary, the synthesizer must be set to the expected receive baud rate. This means that split frequency operation is only allowed when the generator is operated with an external 16-times clock source through the GEN CLK IN BNC input.

**Recovered Operation With DTE/DCE Data Interfaces**

When the frequency is less than 520 kb/s, any data interface that can use synchronous timing (including the internal RS-232 Data Interface) can also be used with recovered timing. When the Clock Recovery option is installed, synchronous data may be analyzed (even if the received clock is missing or unusable) by extracting a clock from the receiver data. To use this feature, the synthesizer frequency must be set to the expected receiver frequency. In normal operation, no problems are encountered when the transmit and receive frequencies are identical. When in receive-only operation, the synthesizer must still be set to the expected receive frequency. To run the FIREBERD in split frequency and also use the option, the synthesizer must be set to the receive frequency and the **GEN CLK** switch must be set to either the INTF or BNC positions with an external source connected to the GEN CLK IN rear panel BNC connector. The receiver frequency and the synthesizer frequency setting may differ by over 1 percent with acceptable operation; however, the best noise immunity is obtained when such differences are minimized. This is accomplished by setting the synthesizer to the expected receiver frequency, reading the actual receiver frequency (RCV FREQ) (available in the SIGNAL results category), and setting the synthesizer accordingly.



TIMING MODE

TIMING MODE

**Select a Mode of Signal Timing  
(Continued)**

**Recovered Timing Operation With Pseudoternary Data Interfaces**

Pseudoternary signals are signals that have the clock embedded in the data. Examples of interfaces that accommodate pseudoternary signals include: DDSLL, T1/FT1, T1, T3, 2MG.704, and 2M/n64. Pseudoternary interfaces include a clock recovery circuit to extract the clock from the pseudoternary signal. Since clock recovery is automatic, the **TIMING MODE** switch is disabled. The INTF position of the **GEN CLK** switch can select either an oscillator on the interface or a clock recovered from the received data, depending on the interface used and its switch settings. The BNC position of the **GEN CLK** switch allows an external time base to be used so that generator timing is synchronous with a system clock source.

**Notes:**

1. When the Clock Recovery Option is not installed, RECOVD is not available when scrolling through the switch positions.
2. When using a data interface where none of three choices apply, the **TIMING MODE** switch does not operate. These interfaces include:

<u>Model:</u>	<u>Interface:</u>
30608	CCITT G.703 64 kb/s Interface
30609	CCITT G.704 2048 kb/s Interface
41800	2M/n64 Interface
30481	DS0/DS0A Interface
30678	DDS DS0A/B Interface
41131	DDS Local Loop Interface
40540	DS1/T1/D4/ESF/SLC-96 Interface
40460	DS1/T1/D4/ESF Interface
41945	DS3 Interface
41075	ISDN S/T TE Interface
42219	HSSI Data Interface

3. Certain interfaces can only operate in one timing mode; in such instances, the **TIMING MODE** switch freezes on that selection (i.e., the user cannot change it). Additionally, the **TIMING MODE** switch locks out the invalid value when an interface can only operate in two of the three timing modes.

**Instrument Description**

**(TM) LED INDICATOR**

**(TM) LED INDICATOR**

**Test Mode (TM) Indicator**

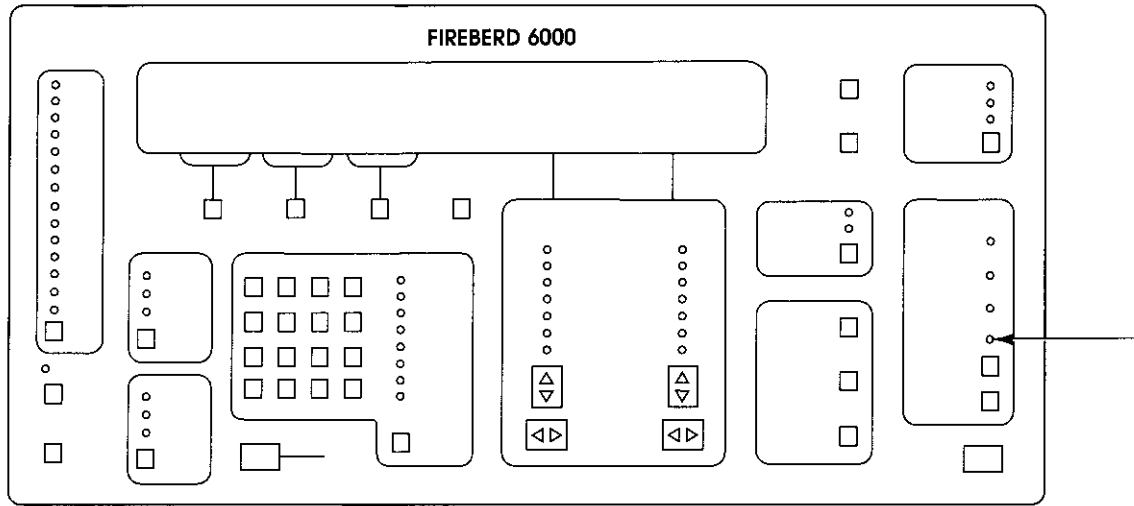

**Front-Panel Component-Type:**

Discrete LED indicator with adjacent label.

**Purpose:**

When a data interface, such as RS-232, V.35, or RS-449 is selected, and the FIREBERD 6000 is emulating a DTE, the (TM) LED indicator shows the state of the Test Mode (TM) line. When the indicator is illuminated, the TM line is enabled; otherwise, the TM line is disabled.

VOLUME

VOLUME

## Control the Audio Level of the Tone Generator

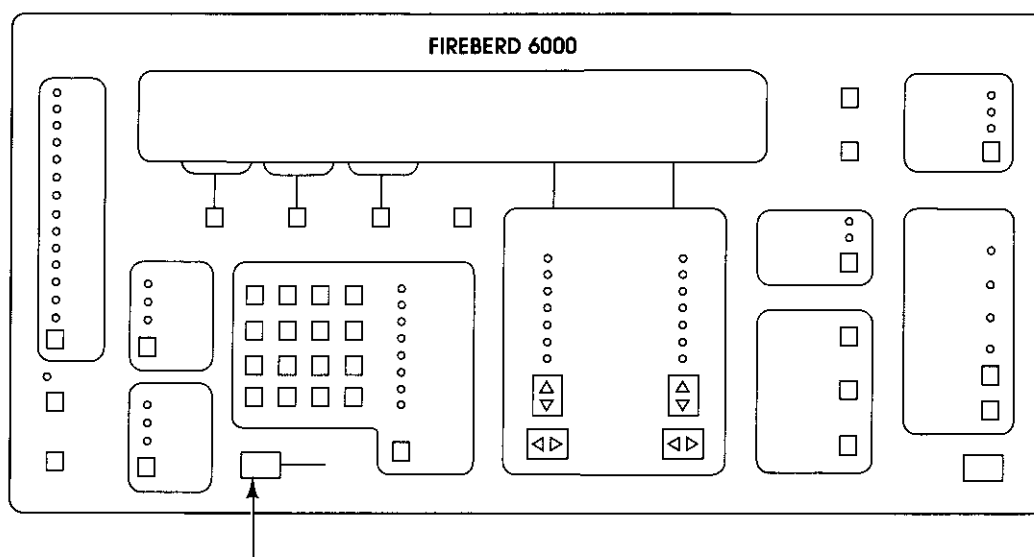
**Front-Panel Component-Type:**

Slide control switch.

**Purpose:**

The **VOLUME** control determines the audio level of the tone generated by the FIREBERD during certain events (e.g., power-up). To increase the audio volume, move the slide control to the right.

**Notes:**

1. The FIREBERD 6000 tone generator features three distinct audible signals based on specific events, as follows:

<b><u>Tone:</u></b>	<b><u>Occurs During:</u></b>
One short "beep"	An invalid keypad entry.
	An errored second when ERR EAS or BIT ERRS are displayed.
Two-tone "beep"	A synchronization loss.
Three-tone "beep"	Completion of a test interval when BER is displayed.

## ***Instrument Description***

### **2.5 REAR PANEL**

The FIREBERD 6000 rear panel hosts all the instrument connections and the slot in which the modular data interface is installed. In addition to the test points and BNC connectors which provide signal access, several other rear-panel features are also available, as shown in Figure 2-12. The numbers in the figure correspond to the numbered descriptions in the following paragraphs.

#### **1. RS-232 PRINTER/CONTROLLER INTERFACE**

The RS-232 Printer/Controller Interface is a female, 25-pin, D-type connector which is configured for asynchronous DCE operation. It is used to send information to a compatible printer for generating printouts of status messages, test results, and mainframe configurations. The interface is also used to connect a device to the FIREBERD 6000 for remote control operation, which can be accomplished using a dumb terminal or a computer with communications software. Section 3 describes the FIREBERD 6000 printer interface; Section 4 describes the remote control interface.

#### **2. IEEE-488 INTERFACE SLOT**

This slot allows the optional IEEE-488 Interface to be inserted in the FIREBERD 6000. When this option is not installed, the slot is covered by a blank plate.

#### **3. FUSE AND VOLTAGE SELECTOR**

The fuse and voltage selector is a small card near the power plug that is used to choose whether the FIREBERD 6000 operates on 115 or 230 volts alternating current (VAC). To select a voltage, remove, rotate, and reinstall the card with the appropriate voltage showing. Any time that the voltage is changed, the fuse must be replaced with another fuse of the proper style and rating. See Section 1.3 for detailed information on voltage selection and fuse replacement.

#### **4. FAN**

A fan mounted on the rear panel permits proper cooling and ventilation of the internal components. It is always in operation when the FIREBERD is turned on, and cannot be operated independently. The fan is protected by a screen which should be checked periodically for dust or blockage. See the Appendix section for instructions on fan screen maintenance.

#### **5. TEST POINTS**

A variety of TTL-level test points are provided for measurement and synchronization purposes, as follows:

**RCVR CLK** - The RCVR CLK output is a buffered version of the clock used by the receiver section of the instrument. Normally, the data at the RCVR DATA test point is valid on the rising edge of the RCVR CLK signal. This output is not valid with asynchronous timing.

**RCVR DATA** - The RCVR DATA output is a buffered version of the data that is sent to the FIREBERD receiver. A LOGIC HIGH represents a received Mark; a LOGIC LOW represents a received Space.

**GEN CLK** - The GEN CLK output is a buffered version of the clock used by the generator section of the instrument. Normally, the data at the GEN DATA test point is valid on the rising edge of the GEN CLK signal. This output is not valid with asynchronous timing.

**GEN DATA** - The GEN DATA output is a buffered version of the generator data being sent to the data interface. A logic high represents a transmitted Mark; a logic low represents a transmitted Space.

**GEN PATT SYNC** - The GEN PATT SYNC output provides a one-bit-wide, high-going pulse once per generated pseudorandom pattern. For example, if the **DATA** switch is set to the 511 position, one GEN PATT SYNC pulse occurs for every 511 data bits generated. If the **DATA** switch is set to the PRGM position, one pulse is provided for every repetition of the 3- to 24-bit pattern. If the **DATA** switch is set to the MK or 1:1 positions, 1 pulse is provided every 24 generator data bits. This output is not valid with asynchronous timing.

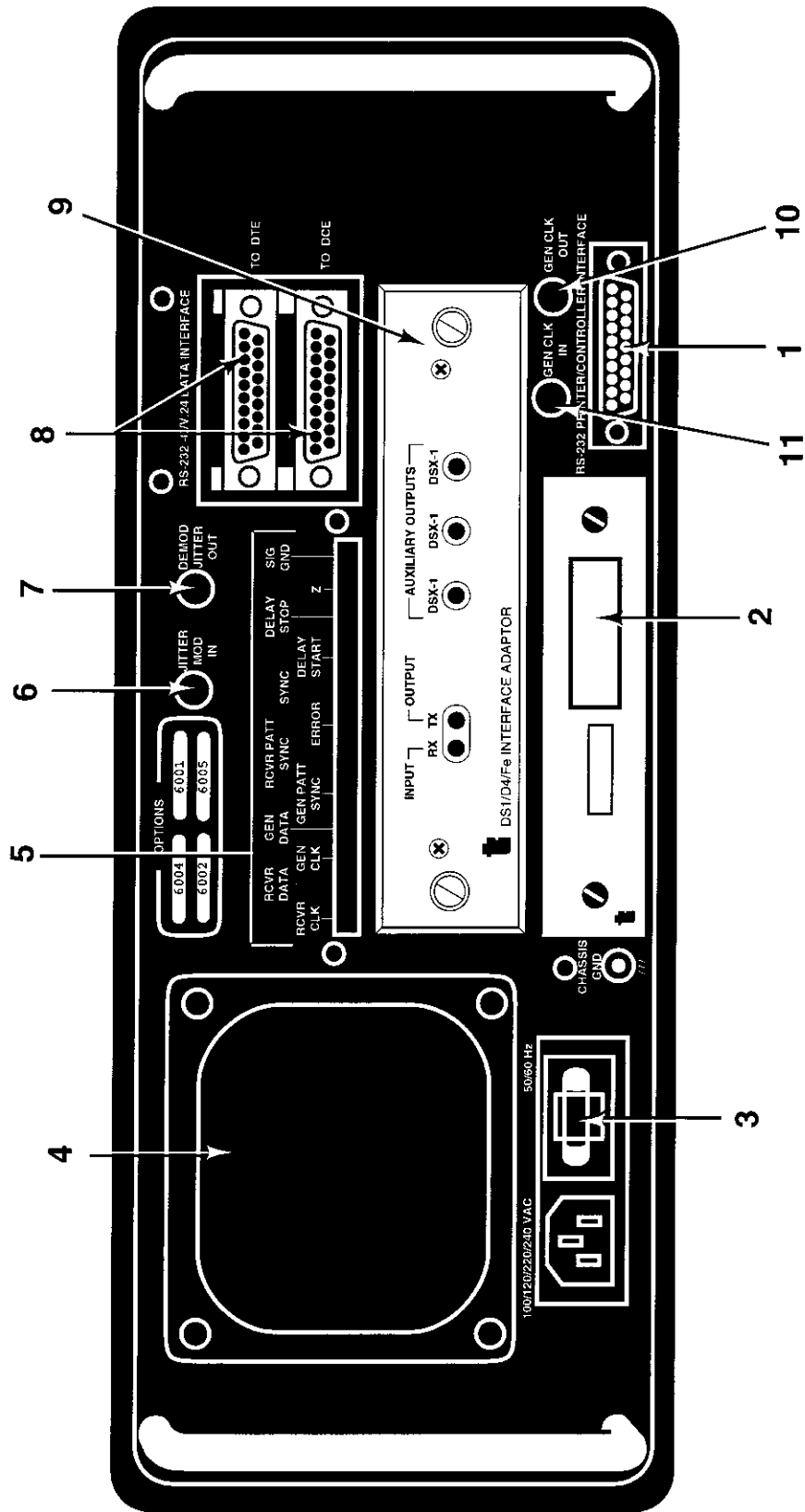

Figure 2-12  
FIREBERD 6000 Rear Panel

## ***Instrument Description***

**RCVR PATT SYNC** - The RCVR PATT SYNC output provides a one-bit-wide, high-going pulse once per received pseudorandom pattern after the receiver has achieved synchronization. When synchronization to a PRGM pattern is achieved, one pulse is provided for each repetition of the 3- to 24-bit pattern. When synchronization is achieved to a Mark or 1:1 pattern, one pulse is provided for every 24 data bits received. This output is not valid with asynchronous timing.

**ERROR** - The ERROR output provides a half-bit-wide pulse each time an error is detected in the received data. This output is not valid with asynchronous timing.

**SYNC** - The SYNC output is at a LOGIC LOW when the receiver is not in synchronization with the received pattern, and is at a LOGIC HIGH when receiver synchronization has been achieved. This output is not valid with asynchronous timing.

**DELAY START** - The DELAY START input is the delay start-of-measurement signal, controlled by auxiliary function 31 (using the TP softkey). Either the rising or falling edge of the signal may be selected.

**DELAY STOP** - The DELAY STOP input is the delay end-of-measurement signal, controlled by auxiliary function 31 (using the TP softkey). Either the rising or falling edge of the signal may be selected.

**Z** - The Z test point provides external indications of alarm conditions and status. It may be turned off or on by remote control.

**SIG GND** - This test point is connected to signal ground.

### **6. JITTER MOD IN**

The JITTER MOD IN is a BNC connector that applies only when the DS1 Jitter Generation option is installed and an interface with jitter capability is used (See the Appendix section). Any signal presented to this connector may be selected to jitter the transmitted T1 or G.703/G.704 signal correspondingly.

### **7. DEMODO JITTER OUT**

The DEMODO JITTER OUT is a BNC connector that applies only when the DS1 Wideband Jitter Measurement option is installed in the FIREBERD and the DS1/D4/Fe Data Interface is used. Jitter on the received T1 signal is extracted and sent to this connector for monitoring. This output can drive a 50-ohm load, and is calibrated at 10 Unit Intervals (UIs) per volt.

### **8. RS-232-C/V.24 DATA INTERFACE DTE/DCE CONNECTORS**

These two female, 25-position, D-type connectors allow separate DTE and DCE operation for the FIREBERD 6000 internal RS-232-C/V.24 Data Interface. The DCE (upper) connector is designed to connect to a DTE under test; the DTE (lower) connector is designed to connect to a DCE under test.

### **9. DATA INTERFACE SLOT**

This slot hosts any modular interface that can be inserted into the FIREBERD 6000. Additionally, the data interface slot can connect the instrument to as many as two ISU-6000 switching units, each of which holds as many as four modular interfaces.

### **10. GEN CLK OUT**

GEN CLK OUT is a BNC connector that provides a buffered version of the generator clock signal. This output is a TTL signal capable of driving a 50-ohm load.

### **11. GEN CLK IN**

GEN CLK IN is a BNC connector that permits an external clock source to be connected to the FIREBERD 6000. In such instances, the instrument **GEN CLK** switch is set to the BNC position. The FIREBERD accepts a sine- or square-wave signal of at least 1.5 volts peak-to-peak from 50 Hz to 15 MHz. GEN CLK IN has a built-in termination of 50 ohms.

## 2.6 PERFORMING ERROR ANALYSIS

To perform error analysis with the FIREBERD 6000, perform the following steps.

1. Determine the type of test configuration required — loopback or end-to-end testing.

If loopback testing is desired, one FIREBERD is required. If end-to-end testing is desired, two test instruments are required; thus, the remaining procedures should be the same for both instruments.

2. With the FIREBERD AC power OFF, install the appropriate data interface in the rear-panel slot. Gently press the interface until its aluminum panel makes contact with the FIREBERD rear panel.

To prevent the interface from being pulled out, tighten the two fasteners at either side of the interface. If the internal RS232 Data Interface is used, no interface needs to be installed in the rear-panel slot.

3. Connect the FIREBERD to an AC power source. Press the **POWER** switch to turn the unit on.
4. If using an interface that can emulate Data Terminal Equipment (DTE) or Data Communications Equipment (DCE), determine which emulation is required.

For example, to emulate a DTE using the internal RS232 Data Interface:

- a) Connect the system under test to the connector marked TO DCE on the FIREBERD rear panel using a standard cable.
- b) Set the **MENU** switch to the INTF SETUP position.
- c) Press the INT232 softkey to select the internal RS232 Interface.
- d) Press the DTE softkey to select DTE emulation.

To emulate a DCE, do the following:

- a) Connect the system under test to the connector marked TO DTE on the FIREBERD rear panel; a DTE/DCE adaptor cable is not required.
- b) Set the **MENU** switch to the INTF SETUP position.
- c) Press the INT232 softkey to select the internal RS232 Interface.
- d) Press the DCE softkey to select DCE emulation.

After selecting an emulation mode, verify that EMULATE DTE or EMULATE DCE label is displayed under the SYNC LOST LED.

5. Finish setting up the interface using the appropriate MENU softkeys. For interfaces offering standard or live results, select standard.

**NOTE:** See the appropriate manual for information on set-up procedures that are specific to your interface.

6. If an external printer or remote controller is desired, connect it to the appropriate printer/remote control interface on the rear panel.
7. Set the **TIMING MODE** switch to the desired position.

## Instrument Description

8. If ASYNC timing is selected in Step 7, set the **MENU** switch to the CHARFORMAT position. Use the softkeys to choose the number of data bits per character, parity, and the number of stop bits per character.
9. Use the **GEN CLK** switch to select a clock source.
10. If ASYNC or RECOVD timing is specified in Step 7, or if SYNTH is specified in Step 9, set the **MENU** switch to the SYNTH FREQ position to select a synthesizer frequency. For asynchronous or recovered timing operation, the frequency must be set to within 1% of the bit rate of the incoming data. Note that the synthesizer frequency needs to be the same as the bit rate of the data to be generated.
11. Use the MENU keypad to type the desired frequency and press the **ENTER** key. Or the MENU softkeys can be used to select one of the 11 pre-programmed frequencies. Frequency restrictions for asynchronous and recovered timing are discussed in Section 1.
12. Set the **DATA** switch to the desired pattern. For end-to-end testing, both test sets must have their **DATA** switches in the same position. Information on the data patterns that can be generated and received by the FIREBERD are described later in this section.
13. If the  $10^{-3}$  indicator is illuminated, press the switch once to turn off error insertion.
14. If not illuminated, press the **SELF LOOP** switch to verify the FIREBERD setup prior to actual system testing.
15. If blocks and block errors are to be measured, use auxiliary function 30 to set the desired block length.
16. Set any other auxiliary functions desired.

**NOTE:** If the AUXFUNC IN USE label (next to the **MENU** switch) is backlit, one or more of the status-select auxiliary functions (1 to 10) are set to values other than their default. Pressing the softkey below the IN USE menu item, when the top level AUXILIARY menu is displayed, scrolls through a list of the auxiliary functions that are not set to their default value. Pressing the softkey below the PAUSE menu item halts the scrolling and pressing the softkey below the EXIT menu item returns to the top level auxiliary menu. Auxiliary function 99 can be used to return all status-select auxiliary functions (1 to 10 and 12) to their default states.

17. If results prints are desired, set the **MENU** switch to the PRINT EVENT category; use the softkeys to select a print mode (NORMAL or DELTA). If NORMAL mode is specified, also set the events that cause a printout to be generated.

Set the **OFF/ON** switch in the PRINTER block to the ON position. This causes the LED in the switch to illuminate.

18. Set the **MENU** switch to the TEST INTERVAL category.
19. Set the test interval to the desired number of received bits or the desired time duration.
20. Set the **ANALYSIS MODE** switch to CONTINUOUS or SINGLE, as appropriate for your test.
21. If the **DISPLAY HOLD** switch is illuminated, press it once to disable it and extinguish the LED in this switch.
22. If the selected data interface allows control of outgoing signaling leads, set them to the desired states. (Signaling lead switches are located above the **POWER** switch. When the LED in the switch illuminates it indicates that the signal identified by the backlit label is in the ON state.)

**RESULT:** The SYNC LED illuminates, indicating that the receiver has synchronized to the generated data.

23. Set the left **CATEGORY** switch to the ERROR position, then use the left **RESULT** switch to bring BIT ERRS into the display. Ensure that no bit errors have been counted (BIT ERRS = 0).



24. Press (but do not hold) the **ERROR INSERT** switch, then verify that a single bit error is visible in the display. Also verify that the red SYNC LOST indicator is not illuminated.

**RESULT:** The FIREBERD has successfully achieved SELF LOOP operation, and is ready to perform testing in standard mode.

25. Press the **SELF LOOP** switch to exit self-loop operation and enter standard mode.

**RESULT:** If all connections are successfully established, the SYNC indicator illuminates and error analysis results are available for display and printout.

### 2.6.1 If Problems Arise

If the error analysis test fails to start (i.e., the SYNC indicators fail to illuminate), verify the following:

- Check the RECEIVER LEDs to verify data activity at the receiver input.
- If performing a synchronous test, set the right **CATEGORY** switch to the SIGNAL position, then use the right **RESULT** switch to select the RCV FREQ result; verify that the frequency of the received clock is the same as the received data rate.
- If emulating a DCE, be sure auxiliary function 07 (Receiver Clock Select) is set properly; if the FIREBERD is using the wrong timing signal to clock in the received data, it prevents receiver synchronization.

Use the two **ANALYSIS RESULTS RESULT** switches to view test results in all categories. Section 1 provides a list of the results available.

## 2.7 PERFORMING TIMING ANALYSIS

Timing analysis refers to the measurement of certain clock signal characteristics used by a synchronous, digital communication system. These measurements provide information that help isolate the cause of clock-related system errors.

Timing analysis results fall into two broad categories:

- Results that do not require receiver synchronization.
- Results that do require receiver synchronization.

### 2.7.1 Setting Up a Timing Analysis Test

To obtain timing analysis results that require receiver synchronization, perform the set-up procedure described in Section 2.6 in its entirety.

Timing analysis results not requiring receiver synchronization can be obtained on clock and data sourced by a FIREBERD 6000 or on live signals. To perform timing analysis on live signals, follow the procedure in Section 2.6 in its entirety, with the following exceptions:

- Those steps that set up the data generator (e. g., setting the **GEN CLK** switch, entering the synthesizer frequency, etc.) can be skipped.
- The SYNC indicator need not illuminate when the **SELF LOOP** switch is turned off.

## ***Instrument Description***

### **2.7.2 Timing Analysis Results Not Requiring Receiver Synchronization**

#### **Detecting Clock Activity**

Clock detection is the most basic timing analysis result provided by the FIREBERD.

When incoming clock activity is not detected, the NO CLK indicator is illuminated. In DCE emulation, this indicator is affected when auxiliary function 07 (Receiver Clock Select) is set to AUTO mode. In this mode, the FIREBERD selects the clock sourced by the DTE on the Terminal Timing (TT) line if it is present; when not present, the instrument selects its own generator clock (Send Timing, or ST). As such, the NO CLK indicator illuminates when no signal is present on the incoming TT line and no activity is detected at the generator clock.

**SUGGESTION:** If a clock is expected from the DTE, set auxiliary function 07 to TT; this forces the FIREBERD to select the TT signal whether it is present or not. When not present, the NO CLK indicator illuminates.

Note also that the GEN CLK switch illuminates when no clock activity is detected at the selected source. When the GEN CLK switch is set to the INTF position, this indicator provides information about timing signals at the interface. In DTE emulation mode, Send Timing is chosen in this position; in DCE emulation, Terminal Timing is chosen.

#### **Improper Phase Relationships**

A more sophisticated form of timing analysis is the detection of an improper phase relationship between the incoming clock and data. If the sampling edge of the clock (as defined by the applicable interface standard) is, on the average, closer to the data transitions than to the mid-bit position, an inverted clock condition is declared and the CLK INV indicator is illuminated.

If the frequency of the receiver clock is slightly different than that of the incoming data (i.e., less than about 2 Hz), the CLK INV indicator flashes the frequency difference as the clock slowly slips by the data.

**SUGGESTION:** Check the C-D CHA result (in the ALARMS category) to count the number of times the CLK INV indicator has changed status since the beginning of the test. This result helps in diagnosing problems that can arise from slowly slipping clocks by “watching” the CLK INV indicator during long-term tests.

#### **Generator/Receiver Clock Frequencies**

Generator and receiver clock frequency measurements diagnose problems resulting from the wrong frequency or improperly selected timing signals. These measurements can also reveal the presence of electrical noise on clock signals. When of sufficient magnitude to impair system operation, such noise generally appear as clock frequency measurements that are somewhat higher than the actual clock rate.

Available in the SIGNAL category of the ANALYSIS RESULTS switch, generator and receiver frequency measurements have 6 digits of resolution and  $\pm 5$  ppm  $\pm 1$  count ( $\pm 1$  ppm  $\pm 1$  count optional) accuracy, regardless of frequency. The FIREBERD measures both simultaneously.

### **2.7.3 Timing Analysis Results Requiring Receiver Synchronization**

#### **Pattern Slips**

The timing measurement that requires receiver synchronization is pattern slips. In a binary, synchronous communication system, one clock edge is expected for each data bit received. If this one-to-one correspondence is lost, even momentarily, a pattern slip occurs. Possible causes of pattern slips include noise on the clock signal, missing or extra clock pulses, and small frequency differences between the data and accompanying clock. Although more rare, a missing data bit(s) (i.e., data slip) also has the effect of disrupting the one-to-one correspondence between clock edges and data bits, and are thus counted as pattern slips.

The FIREBERD 6000 measures pattern slips on pseudorandom data patterns in the Synchronous and Recovered timing modes, and with T1 interfaces, which recover a clock from the incoming data pulses. In recovered clock operation, pattern slips are generally representative of data slips but can also represent the inability of the clock recovery circuit to track the data due to excessive jitter or noise on the received signal.

### **Frequency Deviation Stress Testing**

If the data being analyzed passes through a repeater that recovers clock in order to regenerate the signal, pattern slips can result from failure of the repeater's clock recovery circuit to track the incoming data. The FIREBERD 6000 frequency synthesizer can be used to help diagnose this problem through a technique known as frequency deviation stress testing, performed as follows:

1. Set the **GEN FREQ** switch to the INTF position.
2. Set the **MENU** switch to the SYNTH FREQ position.
3. Offset the frequency slightly from the one expected by the system under test.
4. Set the **ANALYSIS RESULTS CATEGORY** switch to the ERROR category.

**RESULT:** If the pattern slip count or the BER has increased, the system clock recovery is probably faulty. Note that longer pseudorandom patterns increase the stress on clock recovery systems because they contain longer sequences of zeros.

## **2.8 DELAY MEASUREMENTS**

The FIREBERD 6000 measures the delay between the start and finish of these start-of-measurement and end-of-measurement signals.

Start-of-Measurement Signal Sources:

- DTR
- DSR
- RTS
- CTS (emulate DCE only)
- RLSD
- Generator data (GDATA)
- Generator pattern sync pulse\* (GPATT)
- DELAY START rear-panel test point

End-of-Measurement Signal Sources:

- DTR
- DSR
- RTS
- CTS (emulate DTE only)
- RLSD
- Receiver data (RDATA)
- Receiver pattern sync pulse\* (RPATT)
- DELAY STOP rear-panel test point

\*Not available in Asynchronous timing mode or for synchronous user messages. Also, no edge selection is available for these signals.

## Instrument Description

To measure delay, use auxiliary function 31 to select the precise delay interval to be measured. Pressing the START softkey gives access to the list of start measurement signal sources. Once the start-of-measurement signal has been selected using the appropriate softkey, the signal edge selection can be made. The / character represents the rising edge of the indicated signal, which is defined as the OFF-to-ON transition of signaling leads, the Space-to-Mark transition of data signals, and the logic-low-to-logic-high transition of the rear-panel test point inputs. The \ character represents the falling edge of the indicated signal. After making the edge selection for start-of-the-measurement signal, press the  $\Delta$  key twice to return to the top level of the menu. Press the STOP softkey and select the end-of-measurement signal and signal edge to complete the delay measurement setup.

The DELAY result is displayed in the SIGNAL category; note that the ANALYSIS RESULTS display is blanked until the measurement is completed. The measurement is performed with a resolution of 0.1 milliseconds over a range of 0.0 to 9999.9 milliseconds. If the end-of-measurement event is not detected within 99999 milliseconds of the start-of-measurement event, the message; >9999 ms. is displayed.

After a delay measurement is completed, the measurement can be restarted by pressing the **RESTART** switch, changing or reselecting the start-of-measurement or end-of-measurement event, or changing any major switch on the FIREBERD front panel. The DELAY result is blanked whenever the delay measurement circuitry is enabled.

With synchronous and recovered timing and with T1 interfaces, the FIREBERD can measure delay between the generator and the receiver pattern synch pulse. Since these pulses occur at the same place in each pattern, the time delay between these two entities in loopback testing is equal to the round-trip data delay.

To ensure prompt and accurate results, care must be taken in choosing a pseudorandom pattern when making round-trip delay measurements. Specifically, the pattern must be of sufficient length to ensure that transmission of one complete pattern at the operating data rate takes a greater period of time than the longest possible delay to be measured. On the other hand, if the pattern is too long, many seconds will elapse between pattern sync pulses; this means that the user will wait a long time before obtaining a result.

These constraints imply that the best pattern to use is the shortest pattern longer than the minimum usable pattern length, given by the following:

minimum usable pattern length = (data rate) x (maximum delay to be measured)

where data rate is in bits per second, maximum delay to be measured is in seconds, and the minimum usable pattern length is given in bits. If the maximum delay to be measured is unknown, it is probably safe to use 0.7 seconds, which significantly exceeds the round-trip delay through a satellite in geosynchronous orbit of approximately 0.6 seconds.

For example, to make a round-trip delay measurement at 1.544 Mb/s in an environment in which the delay is completely unknown, the minimum usable pattern length would be 1,544,000 b/s x 0.7s = 1,080,800 bits. The shortest pattern provided by the FIREBERD 6000 that exceeds this length is the 2<sup>23</sup>-1 pattern which has a length of 8,388,607 bits. Using this pattern gives a result in less than 6 seconds.

### 2.8.1 Notes on Delay Measurements

When making delay measurements, please note these important items:

1. The receiver must be steadily synchronized to the incoming data. When the receiver is out of sync, it does not supply receiver pattern sync pulses to the delay measurement circuitry, making the round-trip delay measurement impossible. For this reason, the delay measurement is prevented from being initiated until the receiver is in sync.

**NOTE:** This restriction does not apply to delay measurements between other events.

2. Round-trip delay measurements should only be made using the 63, 511, 2047, 2<sup>15</sup>-1, 2<sup>20</sup>-1 or 2<sup>23</sup>-1 pseudorandom patterns. Measurements made using fixed patterns will provide erroneous results, and measurements made using the QRSS pattern will yield results that are 20.5 bit periods longer than the actual delay.

3. Round-trip delay measurements made with pseudorandom patterns are always one-half bit period longer than the actual delay. Under most circumstances, the difference is not noticed because one-half bit period is only 0.1 milliseconds (the resolution of the measurement) at a data rate of 5 kb/s, and even less at higher rates. But if precise measurements are required, one-half bit period should be subtracted from the measured round-trip delay at lower data rates.

## 2.9 CONTENTION CONDITIONS

A contention occurs when two or more interface operating parameters are incompatible with certain mainframe operating parameters. The three possible contentions are as follows:

- Asynchronous frequency contentions
- Asynchronous pattern contentions
- Synchronous pattern contentions

### 2.9.1 Asynchronous Frequency Contention

An asynchronous frequency contention occurs when:

- The **GEN CLK** switch is set to the **ASYNC** position and
- The internal frequency synthesizer has been set to a value greater than 20 kHz.  
When both conditions are detected, the message **ASYNC FREQ CONTENTION** appears in the display.

To remove the asynchronous frequency condition, do either of the following:

1. Select a different internal frequency.
2. Select synchronous timing.

**NOTE:** During an asynchronous frequency contention, the internal clock generator defaults to 20 kHz.

### 2.9.2 Asynchronous Pattern Contention

An asynchronous pattern contention occurs when:

- The **GEN CLK** switch is set to the **ASYNC** position and
- The selected data pattern is not one of the following: **MARK**, 1:1, 63, 511, 2047, 2<sup>15</sup>-1, **FOX**, or **USER 1-3**.

When both conditions are detected, the message **ASYNC PATTERN CONTENTION** flashes in the display.

To remove the asynchronous pattern condition, do either of the following:

1. Select a different pattern.
2. Select synchronous timing.

**NOTE:** During an asynchronous pattern contention, the pattern generator defaults to 1:1.

## ***Instrument Description***

### **2.9.3 Synchronous Pattern Contention**

A synchronous pattern contention occurs when:

- The **GEN CLK** switch is set to the SYNC or RECOV position and
- The **DATA** switch is set to either the FOX or USER position and
- Long User Pattern capability is not installed

When both conditions are detected, the message **SYNC PATTERN CONTENTION** appears in the display.

To remove the synchronous pattern condition, do either of the following:

1. Select a different pattern.
2. Select asynchronous timing.

**NOTE:** During a synchronous pattern contention, the pattern generator defaults to 1:1. Additionally, this condition does not apply when the FIREBERD 6000 is equipped with Long User Pattern capability.

10

11





## SECTION 3 PRINTER INTERFACES

### 3.1 INTRODUCTION

The FIREBERD 6000 is capable of communicating with printers through the internal RS232 Printer/Controller Interface or the optional IEEE-488 Printer/Controller Interface. These printer/controller interfaces enable the user to obtain hard copy printouts of all results and configurations or to remotely control the FIREBERD. This section describes the internal RS-232 Printer/Controller Interface, the **PRINTER** switches, printouts generated, and auxiliary functions used to control printouts.

The FIREBERD printer/controller interfaces are designed to communicate equally well with either a user operating a dumb terminal or a computer running an applications program. When communicating with a user operating a dumb terminal, the FIREBERD runs interactively; that is, it sends a prompt character to the terminal whenever it is ready to receive a command, and it echoes all command characters back to the terminal as the user types them. When communicating with a computer running an application program, the FIREBERD disables the prompt and echo functions. This allows the remote computer to concentrate on sending commands and getting results.

#### 3.1.1 Optional IEEE-488 Printer/Controller Interface

The optional IEEE-488 Printer/Controller Interface, which installs into a slot on the FIREBERD rear panel, complies with the IEEE Standard 488.2 Codes, Formats, Protocols, and Common Commands (ANSI/IEEE Std 488.2 1987). The interface offers either Talk-Only or Addressable operating mode. When operating in Talk-Only mode, the FIREBERD should be connected directly to a listen-only printer. In Addressable mode, the FIREBERD may be connected with up to 14 other devices, 1 of which must be a controller, on an IEEE-488 bus. Auxiliary function 39 shows the current IEEE-488 address in Remote Control mode, or TALK ONLY in Printer mode. (See Section 2 for information on auxiliary function 39.) Refer to Section 4 for remote control information.

#### 3.1.2 RS-232 Printer/Controller Interface

Data communicated via the RS-232 Printer/Controller Interface is asynchronous, serial data, using standard ASCII (American Standard Code for Information Interchange) format characters. The printer interface can operate at baud rates of 300, 1200, 2400, 4800, or 9600. The FIREBERD sends 2 stop bits and expects received data to have 1 or more stop bits. The RS-232 Printer/Controller Interface is configured as data communications equipment (DCE), which allows it to be connected directly to a printer or to any other piece of data terminal equipment. All communications through the RS-232 port are asynchronous using the ASCII-standard character set, with the exception of graphics codes used to produce output to graphics printers such as the PR-40A printer. With the standard RS-232/V.24 Printer/Controller Interface, the FIREBERD can drive most serial printers.

The RS-232 Printer/Controller Interface connector, located at the lower right on the rear panel, is a 25-pin, D-type, female connector. Table 3-1 lists the pin assignments for this rear panel connector.

**Table 3-1  
RS-232 Printer/Controller Interface Connector Pin Assignments**

Pin No.:	Designation EIA/CCITT:	Signal Description:	Status:
1	AA 101	Protective Ground	Connected to chassis ground
2	BA 103	Transmitted Data (TD)	Data transmitted to the FIREBERD (from the controller)
3	BB 104	Receive Data (RD)	Data received from the FIREBERD (to the printer)
5	CB 106	Clear to Send (CTS)	Output HIGH when the FIREBERD is ready to receive
6	CC 107	Data Set Ready (DSR)	Output HIGH when the FIREBERD power is on
7	AB 102	Signal Ground	Connected to signal ground
8	CF 109	Received Line Signal Detector (RLSD)	Output HIGH when the FIREBERD power is on
20	CD 108/2	Data Terminal Ready (DTR)	Input must be HIGH before the FIREBERD can send data

### 3.2 PRINTOUT CONTROLS AND AUXILIARY FUNCTIONS

With the AUXILIARY category selected, enter the auxiliary function number by using the numerical key and then pressing the **ENTER** key. Or if the auxiliary function is not known, press the softkey below the LIST menu item and then press the softkey below the FWD or RVRS menu item to scroll forward or backward through the auxiliary functions.

The following auxiliary functions affect the printouts generated by the FIREBERD:

<u>Auxiliary Function:</u>	<u>Function Controlled:</u>
11	I/O driver selection (printer/remote controller)
35	Result print (the results included in a RESULTS print)
36	Status printout (the status changes that cause a STATUS print)
37	Print format (width, termination, and rate)
38	RS-232 printer (baud rate, data bits, and parity bits)
39	IEEE-488 status

Use these auxiliary functions to select the print driver, the type of result print (Long, Standard, or Custom), what status event changes cause automatic printouts to be generated, the printout format (width, line termination, and printer rate), and the data format (Baud, Data Bits, and Parity). These auxiliary menu choices combine to provide the user with flexibility in generating printouts when using a wide variety of printers.

The printer control switches and the auxiliary functions used to generate these printouts are described in the following paragraphs. The FIREBERD printouts can be divided into five broad categories: results prints, controls prints, status prints, histogram prints, and jitter frequency prints. Note that both the histogram and jitter frequency printouts may be either graphed on an Epson-compatible graphics printer or listed to a terminal.

#### 3.2.1 PRINTER Switches

Three front panel switches (**OFF/ON**, **CONTROLS**, and **RESULTS**), located below the PRINTER label, are used to manually generate printouts on the attached printer. Note that before pressing the **CONTROLS** or **RESULTS** switch, the printer auxiliary menus must be properly set for the attached printer for printouts to be intelligible.

**OFF/ON** - Pressing the **OFF/ON** switch controls the generation of automatic printouts (e.g., timed, error, or status prints). When the LED inside this switch is illuminated, automatic printouts can be generated. When the LED inside this switch is extinguished, only manual printouts are generated. Manual printouts can be generated at any time by pressing either the **CONTROLS** or **RESULTS** switch.

**CONTROLS** - Pressing the **CONTROLS** switch prints out the status of the front panel control settings and the menu selections. Each control printout generated is time- and date-stamped at the top of the printout. A controls print provides enough information to allow a previous FIREBERD test setup to be duplicated. Figure 3-1 illustrates a typical controls printout (with the column width set to 20).

When a result value overflows its buffer, it is preceded by an asterisk (\*).

```

CONTROLS      PRINT
16:18:34    03 JAN 92
SITE:      Alpha
DATA:      2^15-1
ERR INS      OFF
SELF LOOP:  ON
GEN CLOCK:  SYNTH
TIMING MODE: SYNC
SYN FRQ:    64 KHZ
INTERFACE:
INTERNAL RS-232
RI:         OFF
CTS:        OFF
EMULATE:    DTE
DTR:        OFF
RTS:        OFF
TEST INT:   10^5
PRINT EVENT: NOR
TEST INT PRNT: OFF
SYNC LOSS PRNT: OFF
ERROR PRNT: OFF
TIME PRNT:  OFF
ANALY MODE: CON
DISPLAY HOLD: OFF
BLOCK LENGTH:
              1000 BITS
DELAY: DTR/  DTR/
XON CHARACTER:  11
XOFF CHARACTER  13
AUX FUNC IN USE: NONE
PRINT SPEED:    FAST
PRINT TERM:     CR LF
REMOTE:         NONE
PRINTER:        RS-232
RS-232:
DATA BITS:     8
BAUD:          9600
PARITY:        NONE
IEEE-488:      28

```

**Figure 3-1**  
**Typical Controls Printout**

## Printer Interfaces

**RESULTS** - Pressing the **RESULTS** switch generates a printout of accumulated results values. The items included in a results print are determined by the setting of the result print auxiliary selection. Results printout selections are long, standard, or custom. More information about these results printouts is provided later in this section.

Figures 3-2 through 3-4 show sample results printouts (with the column width set to 40).

```
MANUAL PRINT
18:22:4722 JAN 92   SITE ID   Alpha
BIT ERRS           0   AVG BER   0.E-07
BER                0.E-05   EA SEC    11
EF EAS            11   BPVs     0
AVG BPVR          0.E-07   BPV Rate 0.E-05
RCV FREQ          1544000   GEN FREQ 1544000
RCV CODE          AMI     G %EFS   100.00%
IF DS1/T1        40540
```

**Figure 3-2**  
**Standard Results Print**

```
MANUAL PRINT
18:29:0822 JAN 92   SITE ID   Alpha
BIT ERRS           0   AVG BER   0.E-07
BER                0.E-05   EA SEC    32
ERR EAS           0   EF EAS    32
BPVs              0   AVG BPVR  0.E-07
BPV Rate          0.#-05   PAT SLIP  0
ELAP SEC          33   DELAY     0.0.ms
RCV FREQ          1544000   GEN FREQ 1544000
RCV COD           AMI     PAT LOSS  0
PWR LOSS          0   SIG LOSS  0
XSO SEC           0   PATL SEC  0
%PAT SEC          100.00%   AVL SEC   32
%DEG MIN          0   %SES      0.00%
G %EFS            100.00%   G EFS     32
DEG MIN           0   GERR SEC  0
SES              0   UNA SEC   0
%AVL SEC          100.00%   IF DS1/T1 40540
FRAME SYNCABSENT   B8ZS      ABSENT
YELLOW ALARM      NO   EXCESS ZEROS NO
SELF LOOP         ON
```

**Figure 3-3**  
**Long Results Print**

```
MANUAL PRINT
18:40:0922 JAN 92   SITE ID   Alpha
BIT ERRS           0
```

**Figure 3-4**  
**Custom Results Print**

### 3.2.2 Printer-Related Auxiliary Functions

The auxiliary function settings determine the information printed out for the result and control printouts and the format these printouts take. Auxiliary function selections can be viewed by pressing the **MENU** switch until the LED next to the **AUXILIARY** label is illuminated. With the **AUXILIARY** category selected, the fastest way to access the printer-related menus is to enter the auxiliary function numerical value by using the keypad keys and then pressing the **ENTER** key. Or, if the auxiliary function is not known, press the softkey below the **LIST** menu item and then press the softkey below the **FWD** or **RVRS** menu item to scroll through the auxiliary functions.

#### I/O Driver Auxiliary Function (Auxiliary Function 11)

The FIREBERD 6000 can be connected to an RS-232 external printer or communicate with a printer via the optional IEEE-488 Interface. Auxiliary function 11 (I/O Driver Selection) is used to choose either RS-232 or, when installed, IEEE-488 for the printer driver. Two versions of auxiliary function 11 exist, depending on the FIREBERD configuration. Whether or not the IEEE-488 option is installed determines the menu choices displayed when the softkey below the **SELECT** softkey is pressed. The following list indicates the standard configuration menu choices and the menu choices available when the 488 option is installed. Press the softkey below the **Select** menu item to change the **Print/RC** selection.

<u>Standard:</u>		<u>Optional:</u>	
RC:None	Print:232	RC:None	Print:232
RC:232	Print:Remote	RC:488	Print:232
RC:None	Print:None	RC:None	Print:488
RC:232	Print:None	RC:232	Print:Remote
		RC:232	Print:488
		RC:488	Print:Remote
		RC:None	Print:None
		RC:232	Print:None
		RC:488	Print:None

Choosing **Remote** as the **Print** selection causes the prints to be loaded into an internal buffer. Using the **STATUS:PRINT?** query causes one print at a time to be output to the printer.

**NOTE:** For a printout to be generated, the **Print** menu item must be set to either **RS232** or **488**. If **Print** is set to **None**, no printout is generated.

As can be seen from the menu selections, the **Printer** and **RC** menu items cannot be set for the same physical device at the same time.

#### Results Print Auxiliary Function (Auxiliary Function 35)

The results print auxiliary function determines what results are printed when the front panel **RESULTS** switch is pressed or a timed print is generated. Results print selections are:

- Std (Standard)
- Long
- Custom

Depending on the results desired to be printed out, one of these three results prints should be selected.

Items printed out for these three results prints are determined by results values, the interface selected, and other configuration selections.

## Printer Interfaces

A results print is a hard copy of the current results values accumulated by the FIREBERD. Results prints may be initiated by:

- User request, via the **RESULTS** switch (manual print)
- The occurrence of a user-selected print event (automatic print)

### Long, Short, and Custom Printouts

Using auxiliary function 35, the user may choose a fixed printout (STD or LONG) or decide which measurements to include in the results printouts. A long results print includes all available test results; a standard results print (STD) only includes an abbreviated list of commonly-used results. If neither of these selections is suitable, a custom results print may be specified in which the user may selectively include (or exclude) any of the following test results.

<b>%MASK</b>	:percent jitter mask
<b>%ACT SEC</b>	:percent active seconds
<b>%AVL SEC</b>	:percent available seconds
<b>%DEG MIN</b>	:percent degraded minutes
<b>%PAT SEC</b>	:percent pattern sync seconds
<b>%SES</b>	:percent severely errored seconds
<b>%SVS</b>	:percent severely violated seconds
<b>%VF EAS</b>	:percent violation free error analysis seconds
<b>+ LVL dB</b>	:positive signal level (in dB)
<b>+ LVL V</b>	:positive signal level (in volts)
<b>+ WNDR</b>	:positive wander
<b>- LVL dB</b>	:negative signal level (in dB)
<b>- LVL V</b>	:negative signal level (in volts)
<b>- WNDR</b>	:negative wander
<b>1s DEN S</b>	:ones density violation seconds
<b>1SEC CRC</b>	:one-second CRC errors
<b>1SEC JTR</b>	:one-second jitter
<b>15m WNDR</b>	:15 minute wander
<b>24h WNDR</b>	:24 hour wander (maximum peak-to-peak)
<b>ABRT FRM</b>	:aborted frames
<b>AIS SEC</b>	:alarm indication signal seconds
<b>AVG BER</b>	:average bit error rate
<b>AVG BLER</b>	:average block error rate
<b>AVG BPVR</b>	:average bipolar violation ratio
<b>AVG CER</b>	:average code error ratio
<b>AVG CPER</b>	:average C-bit parity error rate
<b>AVG CRC</b>	:average cyclic redundancy check errors
<b>AVG FAS</b>	:average frame alignment signal error rate
<b>AVG FEBE</b>	:average far end block error rate
<b>AVG FER</b>	:average frame error rate
<b>AVG FRM</b>	:average frame size
<b>AVG MFAS</b>	:average multiframe alignment signal error rate
<b>AVG PER</b>	:average parity error rate
<b>AVG REBE</b>	:average remote end block error rate
<b>AVG TPUT</b>	:average throughput
<b>AVG%UTIL</b>	:average percent utilization
<b>AVL SEC</b>	:available seconds
<b>BECN FRM</b>	:backward explicit congestion notification frame
<b>BER</b>	:bit error rate
<b>BER-SES</b>	:bit error rate in non-severely errored seconds

BIT ERRS	:bit errors
BIT SLIP	:bit slips
BLK ERRS	:block errors
BLOCKS	:blocks
BPV %EFS	:bipolar violation percent error free seconds
BPV Rate	:bipolar violation rate
BPV SEC	:bipolar violation seconds
BPVs	:bipolar violations
C-D CHA	:clock-data phase changes
CER	:code error rate
CHAR ERR	:asynchronous character errors
CLK LOSS	:clock losses
CLOCK INVERT	:clock invert
CODE ERR	:code errors
CP E Rt	:C-bit parity error rate
CPAR ERR	:C-bit parity errors
CPE S A	:C-bit parity errored seconds (Type A)
CPE S B	:C-bit parity errored seconds (Type B)
CPE S C	:C-bit parity errored seconds (Type C)
CRC E Rt	:cyclic redundancy check error rate
CRC ERR	:cyclic redundancy check errors
DAT LOSS	:data loss
DAT RATE	:data rate
DATA INVERT	:data invert
DATA STATUS	:ISDN data call status
DATA TEI	:data terminal endpoint identifier
DE FRM	:discard eligibility frame
DEG MIN	:degraded minutes
DELAY	:delay
EA SEC	:error analysis seconds
EF EAS	:error-free error analysis seconds
ELAP SEC	:elapsed seconds
ERR EAS	:errored error analysis seconds
ERR FRM	:errored frame
ERR-SES	:bit errors in non-severely errored seconds
F BPV S	:far end BPV seconds
F CRC E	:far end CRC error events
F F SES	:far end severely errored framing seconds
F FR ES	:far end frame error seconds
F HI CRC	:far end high CRC error seconds
F HS CRC	:far end high and severe CRC error seconds
F LO CRC	:far end low CRC error seconds
F MD CRC	:far end medium CRC error seconds
F MH CRC	:far end medium-high CRC error seconds
F SI CRC	:far end single CRC error seconds
F SLP S	:far end controlled slip seconds
F SV CRC	:far end severely errored CRC seconds
FAS E Rt	:frame alignment signal error rate
FAS ERR	:frame alignment signal errors
FASDIS S	:frame alignment signal distant alarm seconds
FCS ERR	:frame check sequence errors
FE RATE	:frame error rate
FEBE	:far end block errors
FEBE Rt	:far end block error rate
FEBE S A	:far end block errored seconds (Type A)

## Printer Interfaces

FEBE S B	:far end block errored seconds (Type B)
FEBE S C	:far end block errored seconds (Type C)
FECN FRM	:forward explicit congestion notification frame
FEOF S	:far end out-of-frame seconds
FRA ERR	:frame errors
FRA LOSS	:frame losses
FRM CNT	:frame count
FRM OCTS	:frame octets
FRMR	:frame reject frames
G %EFS	:G.821 percent error-free seconds
G %VFS	:G.821 percent violation-free seconds
G EFS	:G.821 error-free seconds
G VFS	:G.821 violation-free seconds
GEN FREQ	:generator frequency
GERR SEC	:G.821 errored seconds
IF	:interface label
JITTER FREQ's	:jitter print header
JTR HITS	:jitter hits
L2 ABORT	:layer 2 aborts
L2 F ERR	:layer 2 frame errors
L2 FRMS	:number of layer 2 frames
LMI ERRS	:local management interface errors
LMI TMOS	:local management interface timeouts
LOST FRM	:lost frames
LVL dBm	:signal level (in dBm)
MAX JTR	:maximum jitter
MAX TPUT	:maximum throughput
MAX ZERO	:maximum zeros
MAX%UTIL	:maximum percent utilization
MF DIS S	:multiframe alignment signal distant alarm seconds
MFAS ERR	:multiframe alignment signal word errors
MFS E Rt	:multiframe alignment signal error rate
NEOF S	:near end out-of-frame seconds
PAR E Rt	:parity error rate
PAR ERR	:parity errors
PAT LOSS	:pattern sync losses
PAT SLIP	:pattern slips
PATL SEC	:pattern sync loss seconds
PAY SRC	:payload source and loopback status
PP LVL V	:peak-to-peak level (in volts)
PP WNDR	:peak-to-peak wander
PRM TIM	:performance report message time
PVC STAT	:permanent virtual circuit status
PWR LOSS	:power losses
PWR STAT	:ISDN power feeding status
R LVL dB	:receive level (in dB)
R LVL V	:receive level (in volts)
RCV BOM	:receive bit oriented message
RCV BYTE	:received byte
RCV CODE	:received code
RCV FAS	:received frame alignment signal word
RCV FEAC	:received FEAC code
RCV FREQ	:receive frequency
RCV MFAS	:received multiframe alignment signal word
RCV NFAS	:received not frame alignment signal word



REBE	:remote end block errors
REBE Rt	:remote end block error rate
REJ FRM	:reject frames
RT DELAY	:round trip delay
RX ABCD	:received ABCD (signaling bits)
RX INFO	:receiver INFO state
RX X1:X2	:received X bits
SELF LOOP	:self loop
SES	:severely errored seconds
SHRT FRM	:short frames
SIG LOSS	:signal losses
SIGL SEC	:signal loss seconds
SIGNALING	:signaling LEDs
SITE ID	:site identification
SMPX CUR	:simplex current
SVS	:severely violated seconds
TEI	:terminal endpoint identifier
TIME/DATE	:time and date
TOT OCTS	:total octets
TS16AIS S	:timeslot 16 alarm indication signal seconds
TX INFO	:transmitter INFO state
UNA SEC	:unavailable seconds
V FR SEC	:violated frame seconds
VCE TEI	:voice terminal endpoint identifier
VF EAS	:violation-free error analysis seconds
VOICE STATUS	:ISDN voice call status
XSO SEC	:excess zero seconds
YEL SEC	:yellow alarm seconds

### Delta Printouts

If DELTA is selected through the PRINT EVENT function of the MENU switch, automatic Delta printouts occur at the end of each test interval. These printouts only contain data accumulated over the last test interval. The Delta printout does not include average error rates, performance analysis results, or other long-term cumulative analysis results. In all other respects, the Delta printout is the same as any NORMAL printout (e.g., format, results selections, etc.). Figure 3-5 illustrates a typical Delta print.

```

DELTA      PRINT
18:41:0522 JAN 92   SITE ID   Alpha
BIT ERRS      0
BER          0.E-06   EA SEC      1
EF EAS        1      BPVs        0
BPV Rate     0.E-06

IF DS1/T1  40540

```

**Figure 3-5**  
**Delta Print**

Status Prints

A status print informs the user of important developments in an ongoing test. Like the results in a results print, the various status messages may be individually enabled or disabled, using auxiliary function 36, and pressing the softkey below the ON/OFF menu item toggles the displayed status between off and on. Setting the displayed status menu item ON enables a printout to be generated when that event occurs. Most status printouts include a status message, the current time/date, and the site identification (ID). These status messages include the following status events:

- INTERFACE
- G.821 TRANSITIONS
- DATA LOSS
- CLOCK LOSS
- SIGNAL LOSS
- SYNC LOSS
- SYNC ACQUIRED
- ASYNCH FRAME ERROR
- RCVR CLOCK POL CHNG
- SIGNALING CHANGE
- POWER UP
- TEST RESTART
- FRAME SYNC LOSS

This allows the user to determine whether G.821 transitions; data, clock, signal, and sync losses; sync acquisition; changes in receiver clock polarity or signaling; power ups; test restarts; and interface-specific status changes cause a printout to be generated. When applicable, these messages also include the count of the number of times they have occurred during the current test.

Figure 3-6 shows several samples of automatically generated status prints (with the column width set to 20). Note that the PRINTER OFF/ON switch must be set to the ON position for status prints to occur.

```
TEST RESTART
16:28:37 29FEB92
SITE:      Alpha

SYNC ACQUIRED  1
16:28:38 29FEB92
SITE:      Alpha

SYNC LOSS      1
16:28:42 29FEB92
SITE:      Alpha

SIGNAL LOSS    1
16:28:43 29FEB92
SITE:      Alpha

SYNC ACQUIRED  2
16:28:46 29FEB92
SITE:      Alpha

G.821 TRANS PRINT
16:29:28 29FEB92
SITE ID     Alpha
BIT ERRS    0
AVG BER     0.E-06
BER         0.E-05
BLOCKS      1135
BLK ERRS    0
EA SEC      42
EF EAS      40
RCV FREQ    1235726
GEN FREQ    2047987
ERR-SES     0
G %EFS      90.00%
IF          2MB G.703
```

**Figure 3-6**  
**Status Prints**

**RS-232 Print Format (Auxiliary Function 37)**

The RS-232 print format auxiliary function allows the printer line width (COLUMN), line termination (TERM), and rate (MODE) to be specified. Pressing the softkey below the menu item scrolls through the available selections. The COLUMN selection determines the number of characters printed on each line, and the TERM selection determines the printer action (carriage return, linefeed, or carriage return and linefeed) taken at the end of a printed line. The MODE selection determines the print speed. The selections for the menu items are:

Column: 20, 40, or 80  
 Term: CR, LF, or CRLF  
 Mode: SLOW (20 characters per second maximum) or FAST (full baud rate)

**RS-232 (Auxiliary Function 38)**

The RS-232 auxiliary function allows the baud rate, number of data bits, and parity bit(s) to be manually selected. These three menu items can be selected by pressing the softkey below each menu item to scroll through the parameter values for each item. Data format menu item selections are:

Baud: 110, 300, 600, 1200, 2400, 4800, or 9600  
 Data: 7 or 8  
 Par: ODD, EVEN, or NONE

**3.2.3 Histogram Print**

A histogram print offers the user a perspective of how a FIREBERD result is changing with time. For example, a histogram could be used to monitor the accumulated bit errors in each hour over a 60-hour period. From this information, the user could determine whether the bit errors were uniformly distributed over the 60 hours or biased toward one point in time.

Histogram analysis of any integer results are initiated and printed using auxiliary function 44. Simultaneous histograms can be created for up to three test results, as follows:

1. Set the **MENU** switch to the **AUXILIARY** position.
2. Select auxiliary function 44.
3. Press the softkey below the **HST #1** menu item, or press the **MORE** key and press the softkey below the **HST #2** or **HST #3** menu item to select the histogram to setup.
4. With the selected histogram visible on the top line, press the **RESULT** softkey until the desired result for the histogram is displayed.
5. Select a test result for histogram analysis. The result can be any one of the following:

<b>1s DEN S</b>	:one's density violation seconds
<b>1SEC CRC</b>	:one-second CRC errors
<b>ABRT FRM</b>	:aborted frames
<b>AIS SEC</b>	:alarm indication signal seconds
<b>AVG TPUT</b>	:average throughput
<b>AVL SEC</b>	:available seconds
<b>BECN FRM</b>	:backward explicit congestion notification frame
<b>BIT ERRS</b>	:bit errors
<b>BLK ERRS</b>	:block errors
<b>BLOCKS</b>	:block errors
<b>BPV SEC</b>	:bipolar violation seconds
<b>BPVs</b>	:bipolar violations

C-D CHA	:clock-data phase changes
CHAR ERR	:asynchronous character errors
CLK LOSS	:clock loss
CODE ERR	:code errors
CPAR ERR	:C-bit parity errors
CPE S A	:C-bit parity errored seconds (Type A)
CPE S B	:C-bit parity errored seconds (Type B)
CPE S C	:C-bit parity errored seconds (Type C)
CRC ERR	:cyclic redundancy check error
DAT LOSS	:data loss
DE FRM	:discard eligibility frame
DEG MIN	:degraded minutes
EA SEC	:errored analysis seconds
EF EAS	:error-free error analysis seconds
ERR EAS	:errored error analysis seconds
ERR FRM	:errored frame
ERR-SES	:bit errors in non-severely errored seconds
F BPV S	:far end BPV seconds
F CRC E	:far end CRC error events
F F SES	:far end severely errored framing seconds
F FR ES	:far end frame error seconds
F HI CRC	:far end high CRC error seconds
F HS CRC	:far end high and severe CRC error seconds
F LO CRC	:far end low CRC error seconds
F MD CRC	:far end medium CRC error seconds
F MH CRC	:far end medium-high CRC error seconds
F SI CRC	:far end single CRC error seconds
F SLP S	:far end controlled slip seconds
F SV CRC	:far end severely errored CRC seconds
FAS ERR	:frame alignment signal errors
FASDIS S	:frame alignment signal distant alarm seconds
FCS ERR	:frame check sequence errors
FEBE	:far end bit errors
FEBE S A	:far end block errored seconds (Type A)
FEBE S B	:far end block errored seconds (Type B)
FEBE S C	:far end block errored seconds (Type C)
FECN FRM	:forward explicit congestion notification frame
FEOF S	:far end out-of-frame seconds
FRA ERR	:frame errors
FRA LOSS	:frame loss
FRM CNT	:frame count
FRM OCTS	:frame octets
FRMR	:frame rejection frames
G EFS	:G.821 error-free seconds
G VFS	:G.821 violation-free seconds
GERR SEC	:G.821 errored seconds
L2 ABORT	:layer 2 frame aborts
L2 F ERR	:layer 2 frame errors
L2 FRMS	:number of layer 2 frames
LOST FRM	:lost frames
MF DIS S	:multiframe alignment signal distant alarm seconds
MFAS ERR	:multiframe alignment signal errors
NEOF S	:near end out-of-frame seconds
PAR ERR	:parity errors
PAT LOSS	:pattern synchronization loss
PAT SLIP	:pattern slips

<b>PATL SEC</b>	:pattern loss seconds
<b>PRM TIM</b>	:performance report message time
<b>REBE</b>	:remote end block errors
<b>REJ FRM</b>	:rejection frames
<b>SES</b>	:severely errored seconds
<b>SIG LOSS</b>	:signal loss
<b>SIGL SEC</b>	:signal loss seconds
<b>SVS</b>	:severely violated seconds
<b>TS16AIS S</b>	:Timeslot 16 alarm indication signal seconds
<b>UNA SEC</b>	:unavailable seconds
<b>V FR SEC</b>	:violated frame seconds
<b>VF EAS</b>	:violation-free error analysis seconds
<b>XSO SEC</b>	:excess zero seconds
<b>YEL SEC</b>	:yellow alarm seconds

6. Press the **UP ARROW** key.
7. Press the softkey below the SCALE menu item.
8. Select a vertical scale using the FWD and RVRS softkey to scroll through the list (10, 20, 50, 100, 200, 500, 1K, 2K, 5K, 10K, 20K, 50K, 100K, 200K, 500K, 1M, 2M, 5M, 10M, 20M, and 50M). AUTO is the recommended setting; AUTO chooses the next higher scale that is greater than the largest sample.
9. Press the **UP ARROW** key twice.
10. Press the SETUP softkey.
11. Press the softkey below the #SMPLS menu item to select the number of histogram samples required. The sample value range is 05 to 60.
12. Press the softkey below the PERIOD menu item to select a time period (1MIN, 15MIN, 1HOUR, or 1DAY).
13. Press the softkey below the FORMAT menu item to select the printout format. Format choices are GRAPH (Figure 3-7) or LIST (Figure 3-8). LIST provides a printed value for the accumulated result and GRAPH provides a plot of the result value.
14. Press the (**UP ARROW**) key.
15. Press the PRINTER OFF/ON softkey to enable automatic histogram printouts. The LED in this switch must be on to generate automatic printouts. However, if this switch is disabled (the LED is extinguished), pressing the softkey below the PRINT menu item generates a manual histogram print.

### **Automatic Histogram Printouts**

Histograms can be generated automatically when the **PRINTER OFF/ON** switch is enabled (the LED in this switch is illuminated). With a printer connected to the FIREBERD printer connector, and auxiliary function 11 (I/O DRIVER SEL) and auxiliary function 37 (PRNT FRMT) set for the printer being used. With ON displayed on the top line of the histogram menu, automatic printouts are generated by the time interval determined by the #SMPLS (samples) and PERIOD menu selections. The time displayed on automatic printouts reflects the time the histogram analysis began accumulating the displayed results. A marker on the horizontal axis of the printout indicates the position of the last sample. An automatic printout causes all three histograms to be generated. Automatic printouts are continuously generated until disabled. Figure 3-7 illustrates an automatic histogram printout in graph format.

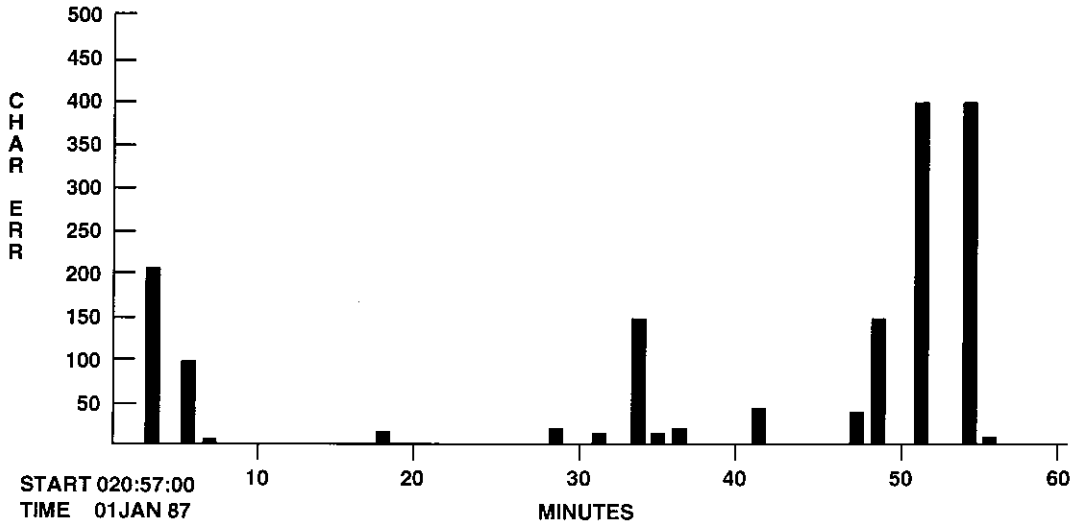

Figure 3-7  
Automatic Histogram Printout, Graph Format

**Manual Histogram Printouts**

An individual histogram (1 to 3) can be manually generated by pressing the softkey below the PRINT menu item. This provides a printout (LIST or GRAPH) of the selected histogram. The manual histogram printout compiles the most recent samples (up to 60) collected. The time displayed on a manual printout is the time the printout was initiated. Generating a manual print does not affect the automatic histograms. Figure 3-8 illustrates a manual histogram printout in list format.

```
HISTOGRAM LIST
20:57:00 12/15/91
SAMPLE SIZE 1 DAY
SAMPLE BIT ERRS
1 0
2 200
3 0
4 93
5 8
6 0
7 0
8 0
9 0
10 0
11 0
12 0
13 0
14 0
15 0
```

Figure 3-8  
Manual Histogram Printout, List Format

Attempting to generate a manual histogram printout before results have accumulated causes the message: **NO SAMPLES READY** to be printed out.

## **Histogram Format**

Histograms can be generated in one of two formats. Both formats, graph and list, present the same information. Regardless of the format selected, each histogram printout can contain one or more of the following symbols.

**Date and Time.** The printed date and time reflects the time the histogram test was started (for automatic printouts) or the time the printout was initiated (manual printouts).

**“S”.** This symbol is printed when the sample period contains a synchronization transition. A sync transition occurs when pattern synchronization is lost and then regained by the FIREBERD.

**“G”.** This symbol is printed when the sample period contains a G.821 transition between available time and unavailable time, as specified in Appendix C.

**“SG”.** Both of these symbols are printed when both sync transitions and G.821 transitions occur in the sample period.

**“\*\*”.** This symbol is printed when the test has begun, but the selected result has not occurred.

**“NO SAMPLES READY”.** This message is printed when a manual printout is initiated before the sample interval is complete.

**“One or more results out of range”.** This message is printed when the result sample total exceeds the selected scale value. To correct this, set the scale higher, or select AUTO.

## **Histogram Graph**

Choosing the graph format causes the histogram printout to be presented in a bar graph format. The test interval is represented on the horizontal axis and the scale is indicated on the vertical axis. The number of samples is indicated by an arrow printed below the horizontal axis. The symbols described previously are printed at the top of the column for the sample interval in which they occurred.

## **Histogram List**

Choosing the list format causes the histogram printout to be presented in a list format. The sample interval is represented by the left column and the result value is indicated in the right column. The symbols described previously are printed on the same line for the sample interval in which they occurred.

### **3.2.4 Jitter Frequency Prints**

When the DS1 Jitter Spectral Analysis option is installed, a jitter frequency list result is also available, either by itself or as part of a results print. This printout contains the jitter measurements for each of the 40 frequencies monitored by the spectrum analyzer. These measurements include the maximum unit intervals of jitter measured at each frequency along with the percentage of the selected jitter mask to which this reading corresponds. When this result is included in a Delta print, it reflects only the measurements made during the current test interval.

Jitter printouts may be initiated in either graphics or list format using the front panel JITTER functions of the **MENU** switch. Note that when generating a graphics print through the RS-232 Interface, the character format must be set for eight data bits.

## Printer Interfaces

Figures 3-9 and 3-10 are examples of the jitter frequency list and graph.

JITTER	FREQ	LIST
15:10:23		10JAN92
MASK:		0.171
FREQ (Hz)	UI	%MASK
10	0.04	0.4
20	0.03	0.3
30	0.02	0.2
40	0.05	0.5
50	0.02	0.2
60	0.01	0.1
70	0.01	0.1
80	0.01	0.1
100	0.02	0.2
133	0.02	0.2
166	0.03	0.3
200	0.02	0.2
233	0.03	0.3
300	0.13	1.9
400	1.06	20.9
500	8.15	201.2
600	0.44	13.0
700	0.14	4.8
800	0.10	3.9
1.0k	0.11	5.3
1.3k	0.05	3.2
1.6k	0.04	3.2
2.0k	0.03	2.9
2.3k	0.03	3.3
3.0k	0.03	4.3
4.0k	0.03	5.7
5.0k	0.05	11.9
6.0k	0.03	8.5
7.0k	0.03	10.0
8.0k	0.04	6.6
10k	0.04	13.3
13k	0.04	13.3
16k	0.01	3.3
20k	0.02	6.6
23k	0.01	3.3
26k	0.01	3.3
30k	0.01	3.3
33k	0.02	6.6
36k	0.02	6.6
40k	0.01	3.3

**Figure 3-9**  
**Jitter Frequency List**



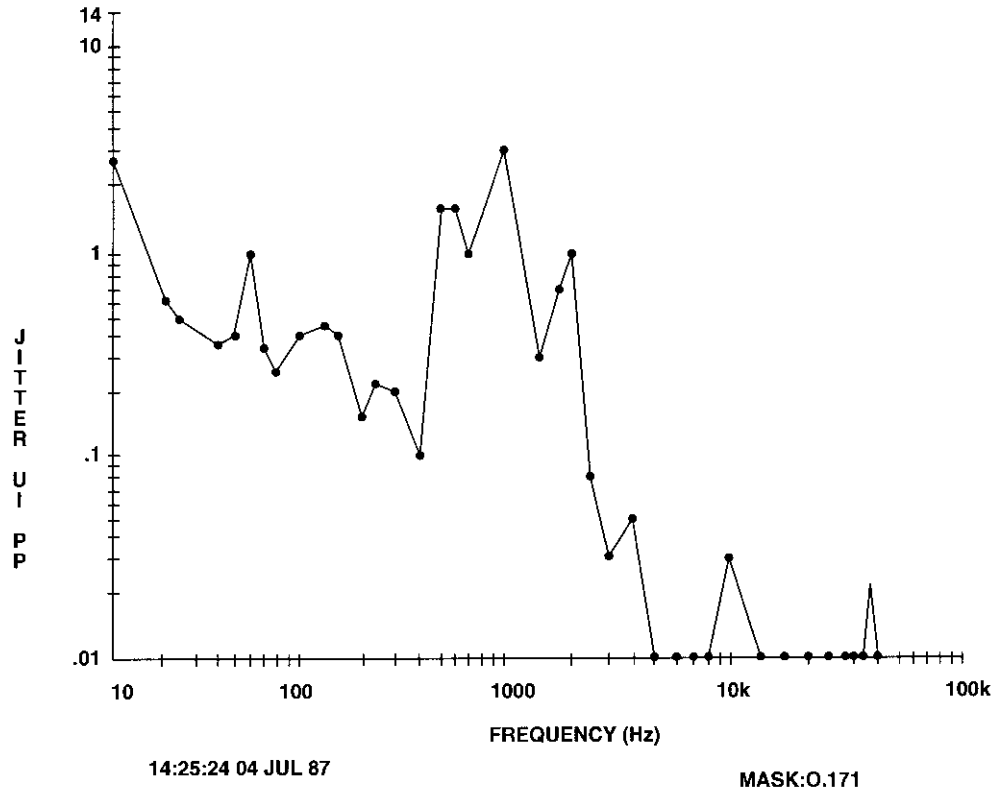
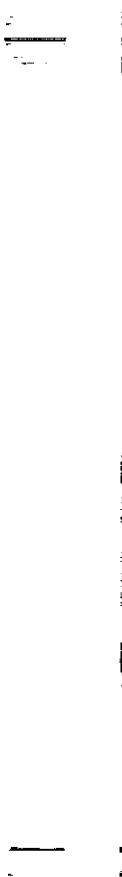

Figure 3-10  
Jitter Frequency Graph



0

1

## SECTION 4 REMOTE CONTROL

### 4.1 INTRODUCTION

This section provides information on controlling the FIREBERD 6000 from a remote device using either the RS-232 Printer/Controller Interface or the optional IEEE-488 Printer/Controller Interface (option 6005).

This section contains information on the following subjects:

- OPERATION - describes the basic set-up and operation of the FIREBERD 6000 from a remote device.
- REMOTE CONTROL CONVENTIONS - describes how to set up tests and read results when under remote control.
- COMMANDS - presents all remote control commands alphabetically by group, describes each command's parameters, and provides examples.
- STATUS REPORTING STRUCTURES - describes the registers and queues that can be used to monitor the FIREBERD 6000.
- REMOTE CONTROL ERROR MESSAGES - contains error messages generated by the FIREBERD 6000.

### 4.2 RS-232 REMOTE CONTROL OPERATION

The RS-232 Printer/Controller Interface is located on the rear panel of the FIREBERD 6000. This interface allows connection by an asynchronous remote device. The interface connector is configured as a DCE and is an EIA RS-232-C-compatible, 25-pin, D-type female connector. Refer to Table 4-1 for pin assignments.

To communicate, the communication parameters of the FIREBERD and the remote controller must match. All communications through the RS-232 Printer/Controller Interface are asynchronous using standard ASCII characters. The interface can operate at baud rates of 110, 300, 600, 1200, 2400, 4800, or 9600 baud. The number of data bits can be either 7 or 8. The parity can be odd, even, or none. The baud rate, data bits, and parity are all set using the AUXILIARY category of the MENU switch.

#### 4.2.1 RS-232 Remote Control Modes

When under RS-232 remote control, the FIREBERD 6000 can operate in either an interactive terminal mode or a non-interactive computer mode.

In the interactive terminal mode, the FIREBERD operates interactively with a remote device such as a dumb terminal or computer by: (1) providing a prompt character when the FIREBERD is ready to receive a command; (2) echoing all characters back to the remote device as they are typed; and (3) transmitting error messages when an execution or command error occurs.

In non-interactive computer mode, a programmed computer sends commands and receives predictable results from the FIREBERD. Thus, prompts, echo characters, and error messages are not sent in computer mode.

In both of these RS-232 remote control modes, the FIREBERD front-panel keys and switches are disabled (except for the **ANALYSIS RESULTS** switches and the **ENTER** key); the message **232 REMOTE CONTROL <ENTER> TO ABORT** appears in the display. If the front panel is placed in local lockout (see **LOCKOUT** command), **<ENTER> TO ABORT** is not displayed. This prevents the front panel from returning to local mode inadvertently.

**Table 4-1  
RS-232 Pin Configuration**

Pin No.:	EIA Dgn.:	Signal Description:	Comments:
1	AA	Protective Ground	Connected to chassis ground.
2	BA	Transmitted Data (TD)	Data transmitted to the FIREBERD.
3	BB	Received Data (RD)	Data received from the FIREBERD.
5	CB	Clear to Send (CTS)	Output HIGH when the FIREBERD is ready to receive.
6	CC	Data Set Ready (DSR)	Output HIGH when the FIREBERD is on.
7	AB	Signal Ground	Connected to circuit ground.
8	CF	Data Carrier Detect (DCD)	Output HIGH when the FIREBERD is on.
20	CD	Data Terminal Ready (DTR)	Input must be HIGH before FIREBERD can send data.

#### 4.2.2 RS-232 Terminal Mode

In terminal mode, the FIREBERD 6000 operates interactively with the remote device.

#### Initiating Terminal Mode

To set up the FIREBERD 6000 for terminal remote control (using the RS-232 Printer/Controller Interface), do the following:

1. Press the **POWER** switch to apply power to the FIREBERD.
2. Set the **MENU** switch to the AUXILIARY position.
3. Using the MENU keypad, type the number **11** and press the **ENTER** key to access auxiliary function 11 (I/O Driver Select). Press the SELECT softkey until **RC:232** appears in the display.
4. Press the **UP ARROW** ( $\Delta$ ) key.
5. Using the MENU keypad, type the number **38** and press **ENTER** to access the 232 auxiliary function.
6. Set the BAUD rate (110, 300, 600, 1200, 2400, 4800, or 9600), DATA bits (7 or 8), and PARITY (odd, even, or none) to match the terminal or terminal emulator settings.
7. Cable the FIREBERD 6000.
8. From the terminal, send a <Control C>.

**RESULT:** A prompt (>) appears on the terminal to indicate that the FIREBERD is ready to receive a command or query. If a prompt does not appear on the terminal, the interface may not be configured properly. Verify the set-up configuration and connections at both the FIREBERD and terminal, or attempt the auto-baud function from the remote device as described later in this section.

When under remote control, the message **232 REMOTE CONTROL** appears in the FIREBERD display. The FIREBERD is placed in remote control mode once it has received a valid command or query.

### Operating in Terminal Mode

In terminal mode, the prompt, echo, and error message functions are enabled. The prompt (>) indicates that the FIREBERD is ready to accept commands and is in interactive terminal mode. Wait for the prompt before sending additional commands to the FIREBERD. All characters are echoed on the terminal as they are typed. Commands can be edited using the backspace key and recalled by pressing the <ESC> key. Once the command has been correctly typed, press the **ENTER** key or **RETURN** key on your terminal to execute the command.

Each command must have the proper syntax and line terminator to be accepted by the FIREBERD. Valid line terminators are: LF (Linefeed), CR (Carriage Return), and CR LF (Carriage Return/Linefeed). When the FIREBERD receives a line terminator it executes all commands entered since the last terminator received. Each output generated in response to a command from the controller is terminated by a Carriage Return and Linefeed (<CR><LF>) and is sent to the terminal before the next prompt.

### Ending Terminal Mode

End terminal mode operation and return control of the FIREBERD to the front panel by sending the **LOCAL** command or pressing the **ENTER** key, on the FIREBERD front panel.

#### 4.2.3 RS-232 Computer Mode

In non-interactive computer mode, a programmed computer sends commands to the FIREBERD 6000 and, in turn, receives predictable results from the test instrument.

### Initiating Computer Mode

To set up the FIREBERD 6000 for computer remote control (using the RS-232 Printer/Controller Interface), perform the following steps.

1. Press the **POWER** switch to apply power to the FIREBERD.
2. Set the **MENU** switch to the **AUXILIARY** position.
3. Using the MENU keypad, type the number **11** and press the **ENTER** key to access auxiliary function 11 (I/O Driver Select). Press the **SELECT** softkey until **RC:232** appears in the display.
4. Press the **UP ARROW** ( $\Delta$ ) key.
5. Using the MENU keypad, type the number **38** and press **ENTER** to access the 232 auxiliary function.
6. Set the **BAUD** rate (110, 300, 600, 1200, 2400, 4800, or 9600), **DATA** bits (7 or 8), and **PARITY** (odd, even, or none) to match the terminal or terminal emulator settings.
7. Cable the FIREBERD 6000.

**NOTE:** If the FIREBERD has not been placed in terminal mode since power has been applied, it is now in computer mode. The interface can also be placed in computer mode by sending the following command:

**RC\_MODE COMPUTER**

The FIREBERD is placed in remote control mode once it receives a valid command or query.

## Remote Control

### Operating in Computer Mode

Computer mode allows a programmed computer to control the FIREBERD. In computer mode, the prompt (>), echo, command line editing, and immediate error responses are disabled; thus, the programmer can be sure that any data received by the computer is data that was specifically requested (via query).

Each command must have the proper syntax and line terminator to be accepted by the FIREBERD. The valid line terminator is LF (Linefeed - 0A Hex). If an invalid command is issued, the FIREBERD does not respond with an error message unless instructed to do so. (See the **STATUS:ERROR?** query described later in this section.)

### Ending Computer Mode

End computer mode operation and control the FIREBERD from the front panel by sending the LOCAL command or pressing the **ENTER** key on the FIREBERD front panel.

#### 4.2.4 RS-232 Auto-Baud Function

The FIREBERD 6000 features an auto-baud function that simplifies RS-232 remote control set-up. This function can be used to place the FIREBERD in terminal or computer mode, and allows a remote user to automatically configure the instrument baud rate, data bits, and parity settings to those of the remote device. To initiate auto-baud from the remote control device, do the following:

1. Press the **POWER** switch to apply power to the FIREBERD.
2. Set the **MENU** switch to the AUXILIARY position.
3. Using the MENU keypad, type the number 11 and press the **ENTER** key to access auxiliary function 11 (I/O Driver Select). Press the SELECT softkey until RC:232 appears in the display.
4. Press the **BREAK** key on your terminal twice at 1-second intervals.

**RESULT:** The flashing message **AUTOBAUD IN PROGRESS** is visible in the RESULTS display.

5. Repeatedly press the **SPACE** bar on your terminal at a rate of 5 to 10 times per second for about 10 seconds or until the following message appears at the remote device.

**Auto-baud achieved. Press <ESCAPE> to continue.**

6. Press the **ESC** key on the terminal. The FIREBERD responds as follows:

**Character format determined.**

**RESULT:** The FIREBERD is placed in the mode of choice prior to autobaud (TERMINAL or COMPUTER). To place the FIREBERD in the opposite mode, see the **RCMODE** command found later in this section. (Note that <Control C> can be used to place the FIREBERD in TERMINAL mode.)

The following explains conditions that can occur in auto-baud mode.

- If auto-baud is not achieved within 30 seconds of initiation, the FIREBERD aborts the function and reverts to its previous RS-232 settings. This timeout is required because many terminals generate a BREAK signal as they power up or down, which causes the FIREBERD to enter auto-baud mode accidentally. Under such conditions, the FIREBERD flashes the message **AUTO BAUD IN PROGRESS** in the RESULTS display until the 30-second timeout occurs. Note that the space bar also aborts auto-baud (if all instrument settings are correctly configured).
- The message **Auto-baud achieved. Press <ESCAPE> to continue.** is transmitted with a format of 7 data bits, 2 stop bits, and even parity. For this reason, the message may appear garbled on terminals that are configured differently. Press the ESC key on your terminal to determine the character format.

#### 4.2.5 Installation Test for RS-232 Operation

To confirm that the FIREBERD 6000 has been properly configured and cabled for remote operation, do the following:

1. Power-up the remote computer or terminal.
2. Press the **POWER** switch to apply power to the FIREBERD.
3. Set the **MENU** switch to the **AUXILIARY** position.
4. Using the **MENU** keypad, type the number **11** and press the **ENTER** key to access auxiliary function 11 (I/O Driver Select). Verify that remote control is set to RS232.
5. Press the **UP ARROW** ( $\Delta$ ) key.
6. Using the **MENU** keypad, type the number **38** and press **ENTER** to access the 232 auxiliary function. Verify that the computer interface parameters (baud, parity, and data bits) are set correctly.
7. Send the FIREBERD the following command with the proper terminator.

**\*IDN?**

8. Verify that the FIREBERD sends the following response:

Telecommunications Techniques Corporation, Fireberd 6000, 0, K

#### 4.2.6 If Test Fails

1. Check all cable connections.
2. Verify that the RS-232 parameters are set properly.
3. Verify that auxiliary function 11 has RS-232 selected as the driver for remote control.
4. Verify that the pins in Table 4-1 are set for their proper output level.

### 4.3 IEEE-488 PRINTER/CONTROLLER INTERFACE

By connecting the FIREBERD IEEE-488 Interface to an IEEE-488 bus, the instrument may be controlled by a programmed computer.

#### 4.3.1 IEEE-488 Remote Control Mode

The FIREBERD IEEE-488 Printer/Controller Interface (Option 6005) complies with the IEEE Standard 488.2 Codes, Formats, Protocols, and Common Commands (ANSI/IEEE Std 488.2 1987). Located on the FIREBERD rear panel, the IEEE-488 Interface allows the test instrument to become part of an IEEE-488 bus system, thus enabling communication with a programmed controller.

The IEEE-488 Interface operates in two modes: **TALK-ONLY** and **ADDRESSABLE**. When operating in **TALK-ONLY** mode, the FIREBERD should be connected to a listen-only printer. In **ADDRESSABLE** mode, the FIREBERD may be connected with up to 14 other devices, one of which must be a controller.



## **Remote Control**

The DIP switch, located on the IEEE-488 Interface, is used to specify an address for the interface (in ADDRESSABLE mode only). The DIP switch configuration is as follows:

	<u>SW1</u>	<u>SW2</u>	<u>SW3</u>	<u>SW4</u>	<u>SW5</u>
(0=DOWN, 1=UP)	A0	A1	A2	A3	A4

Where switch segments 1 to 5 specify the unit address; switch segments 6, 7, and 8 are not used. Note that remote control is only available in ADDRESSABLE mode. ADDRESSABLE mode is automatically selected when the IEEE-488 Interface is selected for remote control by auxiliary function 11.

For example, to set the FIREBERD to address 28, perform the following steps.

1. Set SW1 and SW2 to 0 (down).
2. Set SW3 to SW5 to 1 (up).

### **4.3.2 Installing the IEEE-488 Remote Control Interface**

The IEEE-488 Interface is a user-installable option, as follows:

1. Make sure that power to the FIREBERD 6000 is turned OFF.
2. Insert the IEEE-488 card into the IEEE-488 connector in the FIREBERD rear panel.
3. Use **DIP** switch segments 1 to 5 to specify a unique address.

### **4.3.3 Setting Up the IEEE-488 Remote Control Interface**

To set up the FIREBERD 6000 for remote control operation, do the following:

1. Press the **POWER** switch to apply power to the FIREBERD.
2. Set the **MENU** switch to the **AUXILIARY** position.
3. Using the **MENU** keypad, type the number **11** and press the **ENTER** key to access auxiliary function 11 (I/O Driver Select). Press the **SELECT** softkey to set remote control to IEEE-488 (RC:488).
4. Press the **ENTER** key.
5. Make sure that a unique address has been specified using **DIP** switch segments 1 to 5.
6. Cable the FIREBERD 6000.

When under remote control, the message **488 REMOTE CONTROL** appears in the FIREBERD display. The FIREBERD is placed under remote control once it receives a valid command or query.

### **4.3.4 Initiating and Terminating Communication with the IEEE-488**

To initialize and terminate communication with the IEEE-488 Interface, refer to your controller manual and programming language reference manual.

#### 4.3.5 Installation Test

To verify that the FIREBERD 6000 is configured and cabled correctly, do the following:

1. Apply power to the IEEE-488 controller.
2. Press the **POWER** switch to apply power to the FIREBERD.
3. Set the **MENU** switch to the AUXILIARY position.
4. Using the MENU keypad, type the number **11** and press the **ENTER** key to access auxiliary function 11 (I/O Driver Select). Verify that remote control is set to IEEE488 and that the correct address is specified using auxiliary function 39.
5. Send the FIREBERD the following command with the proper terminator:

**\*IDN?**

**NOTE:** Refer to your controller documentation for details on how to address external devices and how to issue commands.

6. Verify that the FIREBERD sends the following response:

Telecommunications Techniques Corporation, Fireberd 6000, 0, K

#### 4.3.6 If Test Fails

If the FIREBERD 6000 does not provide the specified results:

1. Check all cable connections.
2. Verify that the FIREBERD has been properly enabled and addressed.
3. Verify that the controller is configured properly using the documentation provided with the controller.

#### 4.3.7 Implementation of the IEEE-488.2-1987

This section addresses the Device Documentation Requirements listed in Section 4.9 of the IEEE-488.2 Specification (ANSI/IEEE Std 488.2-1987). Italicized items 1 to 22 correspond to the specific information required by the IEEE-488.2 Specification; the information supplied after each of these items responds to these requirements. Some of the responses reference to other sections of this manual where the information can be obtained.

**NOTE:** In this section, "device" refers to the FIREBERD 6000.

## Remote Control

All devices shall supply information to the user about how the device has implemented this standard. This information shall include:

1. *A list of IEEE-488.1 Interface Function subsets implemented.*

The 488.1 Interface Functions subsets are implemented in the FIREBERD 6000 as follows:

SH1: Source Handshake capability  
AH1: Acceptor Handshake capability  
T5: Basic Talker capability with Serial Poll, Talk Only, and Unaddress if MLA  
L4: Basic Listener capability with Unaddress if MTA  
SR1: Status Request capability  
RL1: Remote/Local capability  
DC1: Device Clear capability  
DT1: Device Trigger capability  
PP1: Parallel Poll capability  
CO: No controller capability  
E2: Three-state drivers used

2. *A description of when a user-initiated address change is recognized by the device.*

If the address is changed using the DIP switch segments on the interface, the change takes effect immediately. The valid address range is 0 to 30.

**NOTE:** Verify that this command is executed before attempting to communicate with the FIREBERD at its new address.

3. *A description of the device settings at power-on and any commands which modify the power-on setting.*

All of the device settings are preserved from power-off to power-on; thus, all commands which configure the FIREBERD 6000 will modify the power-on settings. The FIREBERD is shipped with the factory-default settings listed under the \*RST command. These settings are restored when the user performs the CLEAR NOVRAM operation or when the \*RST command is executed.

**NOTE:** The RS-232 remote control mode always powers-on in the computer mode.

4. *A description of message exchange options.*

a. *The size and behavior of the input buffer.*

The input buffer is 100 bytes long. This does not restrict the length of a program message to 100 bytes, since program messages are parsed as they are received.

b. *Which queries return more than one <RESPONSE MESSAGE UNIT>.*

No queries return more than one <RESPONSE MESSAGE UNIT>.

c. *Which queries generate a response when parsed.*

All queries generate a response when parsed.

d. *Which queries generate a response when read.*

No queries wait until the device is read to generate a response.

- e. *Which commands are coupled.*

The configuration selection commands (**AUX:PATTERN**, **CONFIG:TIMING\_MODE**, **CONFIG:FREQ**, and **CONFIG:PATTERN**) and the jitter generator commands (**JITTER:GEN:MOD**, **JITTER:GEN:FREQ**, and **JITTER:GEN:AMP**) are coupled. For more information on these commands refer to the corresponding command paragraphs found later in this section.

5. *A list of functional elements used in constructing the device-specific commands, including whether <compound command program header> elements are used.*

<Compound command program header> elements are used. Each functional element is listed later in this section.

6. *A description of any buffer size limits related to block data.*

Block data elements are not used.

7. *A list of the <PROGRAM DATA> elements which may appear within an <expression>, as well as the maximum sub-expression nesting depth. Any additional syntax restrictions which the device may place on the <expression> shall also be included.*

<expression>s are not implemented.

8. *A description of the response syntax for every query.*

This information is offered later in this section.

9. *A description of any device-to-device message transfer traffic which does not follow the rules for <RESPONSE MESSAGE> elements.*

No device-to-device message transfer traffic is implemented.

10. *The size of any block data responses.*

No block data responses are implemented.

11. *A list of common commands and queries which are implemented.*

See the COMMON COMMANDS found later in this section.

12. *A description of the state of the device after successful completion of the Calibration query.*

The Calibration query is not implemented.

13. *The maximum length of the block used to define the trigger macro, if \*DDT is implemented.*

\*DDT is not implemented.

14. *The maximum length of macro labels, the maximum length of the block used to define a macro, and how recursion is handled during macro expansion, if the macro commands are implemented.*

Macro commands are not implemented.

15. *A description of the response to the identification common query, \*IDN?*

See the command **\*IDN**, described later in this section.

## Remote Control

16. *The size of the protected user data storage area, if the \*PUD command and \*PUD? query are implemented.*

\*PUD and \*PUD? are not implemented.

17. *The size of the resource description, if the \*RDT command and \*RTD? query are implemented.*

\*RDT and \*RTD? are not implemented.

18. *A description of the states affected by \*RST, \*RCL, and \*SAV.*

These commands all affect the same set of instrument settings. Refer to the instrument settings listed under the \*RST command in the common command paragraphs.

19. *A description of the scope of the self-test performed by the \*TST? query.*

See the \*TST command, described in the common command paragraphs.

20. *A description of additional status data structures used in the devices status reporting.*

The Status Reporting paragraphs, found later in this section, describe this topic.

21. *For each command, a statement describing whether it is sequential or overlapped.*

All commands are sequential. None overlap.

**NOTE:** The execution order is modified in the case of coupled commands, but it is still sequential (i.e., not overlapped).

22. *For each command the device documentation shall specify the functional criteria that are met when an operation complete message is generated in response to that command.*

When the **OPERATION COMPLETE** message is generated, the function of any given command has been performed. This means that the general description of each command, found later in this section, constitutes the criteria met when this message is generated.

## 4.4 CONVENTIONS

The following paragraphs provide information on the conventions used by the FIREBERD 6000 while under remote control. The communication between the FIREBERD and the controller is based on the IEEE-488.2 Specification, which standardizes the way instruments talk and listen to one another. By making these instruments consistent in behavior, control software becomes easier to write and maintain.

### 4.4.1 Message Exchange Protocol

The communication between the FIREBERD 6000 and the controller consists of messages known as commands, queries, and responses.

#### **COMMANDS — Program the FIREBERD**

Commands are sent from the controller to the FIREBERD. The FIREBERD interprets and executes each command issued. Commands can alter the FIREBERD set-up or affect the test in progress. Each command is composed of a header, associated data, and a terminator.

#### **QUERIES — Obtain Set-Up Information and Results from the FIREBERD**

Queries are sent from the controller to the FIREBERD. The FIREBERD interprets and responds to each query. Queries are composed of a header, immediately followed by a question mark (?) and a terminator.

#### **RESPONSES — Answer a query**

Responses are sent from the FIREBERD to the controller to answer a query.

#### 4.4.2 Program Messages

All communication sent from the controller to the FIREBERD 6000 is in the form of <program messages>. A <program message> is a series of commands and/or queries, each separated by a semicolon (;). This is useful when several commands may have to be coupled into one <program message> to avoid unit contention. A terminator is sent by the controller to identify the end of the <program message>. In RS-232 terminal mode operation, the terminator is either a CR (Carriage Return), LF (Linefeed), or CRLF (Carriage Return/Linefeed); in RS-232 computer mode operation, the terminator is LF; in IEEE-488 operation, the terminator can be LF or any character sent with an EOI (End or Identify) signal asserted.

In RS-232 terminal mode, the FIREBERD executes all commands and queries of the last program message in sequence when receiving a terminator from the controller. As commands and queries are processed and executed, space is made available in the input buffer. If the input buffer is full, the result is lost data, which generates errors.

In IEEE-488 and RS-232 computer mode, the FIREBERD executes commands and queries as they are received. Commands and queries in the input buffer cannot be overwritten; thus, the FIREBERD stops accepting commands while the input buffer is full.

#### 4.4.3 Response Messages

The basic communication rule between the FIREBERD 6000 and the controller is that the FIREBERD only responds when the controller sends a query. In turn, the FIREBERD sends its response to the query before a new program message is sent.

In RS-232 applications, the FIREBERD sends a response as it is generated. In IEEE-488 applications, the response is stored in the output queue until the FIREBERD is addressed to talk. If a new program message is sent to the FIREBERD before the initial response, the initial response is discarded and a RESPONSE INTERRUPTED error is generated. The new program message is executed normally.

The communication sent from the FIREBERD 6000 to the controller is in the form of a <response message>. When using either the RS-232 terminal or computer mode of operation, the <response message> is sent immediately after the query is received. When using IEEE-488, the response message is sent when the FIREBERD is addressed to talk.

A <response message> consists of one <response message unit> per query of the preceding <program message>. If several responses are contained in a <response message> each is separated by a semicolon (;). The entire <response message> is ended by a terminator. The terminator for RS-232 terminal mode operation is CRLF; for RS-232 computer mode operation, LF; and for IEEE-488 operation, LF accompanied by an EOI signal. To determine the exact format of the <response message unit> for any given query, refer to the following command and query examples.

### 4.5 UNIT CONTENTION

The FIREBERD 6000 can be in contention, due to front panel control settings, when in local control. However, contention is not permitted when under remote control. If a contention condition exists when remote control is entered, settings are automatically selected that eliminate the contention condition. For example, if a synchronous pattern contention, asynchronous pattern contention, or asynchronous frequency contention exists, the 2<sup>15</sup>-1 pseudorandom pattern and synchronous timing mode are selected. Also, if a jitter generator contention exists, the jitter modulation is turned off.

Certain combinations of synthesizer frequency, data pattern, and timing mode settings are not valid. Thus, if a command causes a contention condition, a contention error appears in the error buffer and the previous setting is retained.

The execution certain command combinations are delayed until all the commands of a <program message> have been read by the FIREBERD. This is done because the final result of the <program message> may not cause a contention. For example, if the FIREBERD is set for synchronous timing mode and a synthesizer frequency of 64 kHz; sending the <program message> **CONFIG:TIMING\_MODE ASYNC;FREQ 1.2** would result in an asynchronous frequency contention if the commands were executed simultaneously. This is because the FIREBERD would try to go to asynchronous timing mode, but the synthesizer frequency would still be set to 64 kHz, resulting in the FIREBERD remaining in the synchronous timing mode. However, both the synthesizer frequency and timing mode are changes, since the execution of these commands are delayed and then executed simultaneously.

## **4.6 REMOTE CONTROL COMMANDS**

The following paragraphs describe how to enter remote control commands with the proper command syntax, lists the commands by group, alphabetically describes each of the commands and parameters, and provides examples.

All examples shown in this section use the terminal mode format with printouts in a 40-column width. The commands are shown in upper case characters. The commands may be entered in either upper case or lower case characters.

Each remote control command is associated with a command group, as follows:

**COMMON COMMANDS:** Commands and queries that are common to all instruments.

**AUXILIARY COMMANDS:** Provide remote control access to the FIREBERD 6000 auxiliary functions.

**CONFIGURATION COMMANDS:** Remotely control any test configuration.

**INTERFACE COMMANDS:** Provide the ability to operate the FIREBERD 6000 interfaces via remote control.

**JITTER COMMANDS:** Provide remote control access to the FIREBERD 6000 jitter generation and measurement capability.

**PRINT COMMANDS:** Control the FIREBERD 6000 print capability.

**REMOTE CONTROL COMMANDS:** Set functions that are not grouped with other commands.

**RESULT COMMANDS:** Retrieve test results.

**STATUS COMMANDS:** Set and read the status reporting registers, queues, and buffers.

### **4.6.1 Remote Control Commands**

The following paragraphs present all of the remote control commands, in their associated group, in alphabetical order. Each command and/or query includes an explanation of the command/query and a brief example of its usage. Bold characters are used throughout this section to indicate the commands, as well as the variables to be entered with the commands. The variable choices are listed within brackets and separated by vertical lines.

## AUXILIARY COMMANDS

The FIREBERD 6000 features a set of commands and queries that offer remote access to the auxiliary functions.

The auxiliary commands and queries accepted by the FIREBERD 6000 are:

Commands	Queries
AUX:ASYN_TIMEOUT	AUX:ASYN:TIMEOUT?
AUX:BLOCK_LEN	AUX:BLOCK_LEN?
AUX:CLEAR_MEM	
AUX:COMMON_FREQS	AUX:COMMON_FREQS?
AUX:DATE	AUX:DATE?
	AUX:DELAY?
AUX:DELAY:START	AUX:DELAY:START?
AUX:DELAY:STOP	AUX:DELAY:STOP?
	AUX:DEVICE_SEL?
AUX:FRAME_RELAY	AUX:FRAME_RELAY?
AUX:GEN_CLK_POL	AUX:GEN_CLK_POL?
AUX:GEN_DATA_INV	AUX:GEN_DATA_INV?
AUX:IN_USE:CLEAR	
	AUX:IEEE488:ADDR?
AUX:INBAND_FLOW	AUX:INBAND_FLOW?
	AUX:IN_USE?
AUX:OUTBAND_FLOW	AUX:OUTBAND_FLOW?
AUX:PATTERN:APPEND	
AUX:PATTERN:INSERT	
AUX:PATTERN:REPLACE	
AUX:PATTERN:DELETE	
AUX:PATTERN:DATA	AUX:PATTERN:DATA?
	AUX:PATTERN:SIZE?
AUX:PATTERN	AUX:PATTERN?
AUX:PRGM_PATTERN	AUX:PRGM_PATTERN?
AUX:RCV_CLK_POL	AUX:RCV_CLK_POL?
AUX:RCV_CLK_SEL	AUX:RCV_CLK_SEL?
AUX:RS232?	
AUX:RS232:BAUD	AUX:RS232:BAUD?
AUX:RS232:DATA_BITS	AUX:RS232:DATA_BITS?
AUX:RS232:PARITY	AUX:RS232:PARITY?
AUX:SINGLE_XMIT	AUX:SINGLE_XMIT?
AUX:SITE_ID	AUX:SITE_ID?
AUX:SYNCLOSS_ACT	AUX:SYNCLOSS_ACT?
AUX:SYNCLOSS_THR	AUX:SYNCLOSS_THR?
AUX:TIME	AUX:TIME?
AUX:USR_SYNC_THR	AUX:USR_SYNC_THR?
AUX:USR_SYNC_THR:BYTES	AUX:USR_SYNC_THR:BYTES?



---

**ASYN\_TIMEOUT****Asynchronous Data Timeout****command/query**

**AUX:ASYN\_TIMEOUT [OFF|ON]** sets the timeout status for asynchronous data. ON forces a synchronization loss if no data is received within a time period of 10 seconds; OFF does not force a timeout

**ASYN\_TIMEOUT?** requests timeout status for asynchronous data

This remote control command is identical to **auxiliary function 46** when the FIREBERD is controlled from the front panel.

Example:

>**AUX:ASYN\_TIMEOUT?** requests the current status of asynchronous data timeout the asynchronous  
OFF timeout function is off

>**AUX:ASYN\_TIMEOUT ON** activate the asynchronous timeout function

---

**BLOCK\_LEN****Block Length****command/query**

**AUX:BLOCK\_LEN (block length)** set block length

**AUX:BLOCK\_LEN?** sets the number of bits in each block (as referred to by the block analysis results).  
The (block length) can be any number of bits within the range 100 to 1000000

This remote control command is identical in function to **auxiliary function 30** when the FIREBERD is controlled from the front panel.

Example:

>**AUX:BLOCK\_LEN?** requests the current block length  
1000 bits

>**AUX:BLOCK\_LEN 25000** make the new block length 25,000 bits

---

**CLEAR\_MEM****Clear NOVRAM****command**

**AUX:CLEAR\_MEM** clears all of the FIREBERD 6000 non-volatile RAM (NOVRAM) in the FIREBERD

**NOTE:** This command should be used with extreme caution since it wipes out all pre-set configurations, auxiliary functions, front-panel programs, etc.

This remote control command is identical in function to **auxiliary function 43** when the FIREBERD is controlled from the front panel.

Example:

>**AUX: CLEAR\_MEM**                      clear NOVRAM

## COMMON\_FREQS

### Program Common Frequencies

command/query

**AUX:COMMON\_FREQS (number), (frequency)**                      set number and frequency. Allows the user to program commonly used synthesizer frequencies by number. The (number) can be any integer within the range 1 to 11; (frequency) can be any frequency within the range .05 to 15000 kHz. The default frequencies are identical to those on the FIREBERD 6000 front panel

**AUX:COMMON\_FREQS? (number)**                      requests the current synthesizer frequency assigned to a specific number

This remote control command is identical in function to **auxiliary function 32** when the FIREBERD is controlled from the front panel.

Example:

>**AUX:COMMON\_FREQS? 2**                      requests the current synthesizer frequency assigned to No. 2  
2.4

>**AUX:COMMON\_FREQS 2,2048**                      change synthesizer frequency No. 2 to 2048 kHz

## DATE

### Set and Display Date

command/query

**AUX:DATE "(date)"**                      set the date. The date is entered within quotes by month, day, and year in a dd/mm/yy format

**AUX:DATE?**                      requests the current date

This remote control command is identical in function to **auxiliary function 60** when the FIREBERD is controlled from the front panel.

Example:

>**AUX:DATE "10/14/91"**                      set the date to Oct. 14, 1991

>**AUX:DATE?**                      requests the current date  
"10/14/91"

DELAY

Delay Measurement

command/query

<b>AUX:DELAY:START “(event)”</b>	set the start event for the delay measurement
<b>AUX:DELAY:STOP “(event)”</b>	set the stop event for the delay measurement
<b>AUX:DELAY:START?</b>	requests the current start event
<b>AUX:DELAY:STOP?</b>	requests the current stop event
<b>AUX:DELAY?</b>	requests the current start and stop events

This series of commands and queries define the parameters for the FIREBERD 6000 delay measurement.

The **AUX:DELAY:START** and **AUX:DELAY:STOP** commands set the start and stop events. Delay measurements start upon detection of the START “(event)” and stop on the detection of the STOP “(event)”. The valid START and STOP “(event)”s are:

<b>DTR/</b>	rising edge of interface DTR signal
<b>DTR\</b>	falling edge of interface DTR signal
<b>DSR/</b>	rising edge of interface DSR signal
<b>DSR\</b>	falling edge of interface DSR signal
<b>RTS/</b>	rising edge of interface RTS signal
<b>RTS\</b>	falling edge of interface RTS signal
<b>CTS/</b>	rising edge of interface CTS signal
<b>CTS\</b>	falling edge of interface CTS signal
<b>RLSD/</b>	rising edge of interface RLSD signal
<b>RLSD\</b>	falling edge of interface RLSD signal
<b>TP/</b>	rising edge of rear panel test point
<b>TP\</b>	falling edge of rear panel test point
<b>GPATT or RPATT</b>	generator or receiver pattern (START or STOP respectively)
<b>GDATA/ or RDATA/</b>	generator or receiver data (START or STOP) rising edge
<b>GDATA\ or RDATA\</b>	generator or receiver data (START or STOP) falling edge

This remote control command is identical in function to **auxiliary function 31** when the FIREBERD is controlled from the front panel.

Example:

<b>&gt;AUX:DELAY:START?</b> “RTS/”	requests the current delay start event the rising edge of the RTS interface signal is the current delay start event
<b>&gt;AUX:DELAY:START “CTS/”</b>	change the delay start event to the rising edge of the CTS interface signal
<b>&gt;AUX:DELAY:STOP?</b> “DTR\”	requests the current delay stop event the falling edge of the DTR interface signal is the current delay stop event
<b>&gt;AUX:DELAY:STOP “DTR/”</b>	change the delay stop event to the rising edge of the DTR interface signal
<b>&gt;AUX:DELAY?</b> “CTS/, DTR/”	requests the current delay start and stop events

**DEVICE\_SEL****Report Current Remote Control and Printer Settings****query**

**AUX:DEVICE\_SEL?** requests the currently selected standard for remote control and print devices. When issuing the query, the remote control setting is displayed first, followed by the printer setting

This remote control command is identical in function to **auxiliary function 11** when the FIREBERD is controlled from the front panel.

Example:

>**AUX:DEVICE\_SEL?** requests the currently selected standard for remote control and printing  
488, 232

**FRAME\_RELAY****Frame Relay****command/query**

**AUX:FRAME\_RELAY [ON|OFF]** sets the Frame Relay option status. ON enables the Frame Relay option; OFF disables the Frame Relay option

**AUX:FRAME\_RELAY?** requests the current status of Frame Relay option

This remote control command is identical in function to **auxiliary function 12** when the FIREBERD is controlled from the front panel. Refer to Appendix F for the remaining Frame Relay remote control commands to control this auxiliary function when it has been set ON.

Example:

>**AUX:FRAME\_RELAY?** requests the currently selected Frame Relay option status  
ON

**GEN\_CLK\_POL****Generator Clock Polarity****command/query**

**AUX:GEN\_CLK\_POL [NORMAL|INVERT]** sets the FIREBERD generator clock polarity. NORMAL sets generator clock polarity to the current interface standard; INVERT sets generator clock polarity to the inverse of the interface standard. NORMAL is the default

**AUX:GEN\_CLK\_POL?** requests the current status of generator clock polarity

## AUXILIARY COMMANDS

---

This remote control command is identical in function to **auxiliary function 1** when the FIREBERD is controlled from the front panel.

Example:

```
>AUX:GEN_CLK_POL NORMAL      set generator clock polarity to normal
>AUX:GEN_CLK_POL?           then display its status
NORMAL
```

## GEN\_DATA\_INV

---

Generator Data Invert

command/query

**AUX:GEN\_DATA\_INV [OFF|ON]** select inverted/non-inverted data generation. OFF selects non-inverted data; ON inverts all data generated by the instrument. OFF is the default selection

**AUX:GEN\_DATA\_INV?** requests the current generator data inversion status

This remote control command is identical in function to **auxiliary function 6** when the FIREBERD is controlled from the front panel.

Example:

```
>AUX:GEN_DATA_INV?          display the current status
ON                          all generated data is currently inverted
>AUX:GEN_DATA_INV OFF      turn inverted data off
```

## IEEE488:ADDR

---

Return the Current IEEE-488 Address

query

**AUX:IEEE488:ADDR?** requests the current IEEE-488 address

This remote control command is identical in function to **auxiliary function 39** when the FIREBERD is controlled from the front panel.

Example:

```
>AUX:IEEE488:ADDR?        requests the current IEEE-488 address
20
```

---

**INBAND\_FLOW**

---

**In-Band Flow Control****command/query**

- AUX:INBAND\_FLOW [OFF|ON]** enable or disable in-band flow control. When OFF is selected, the FIREBERD does not respond to XON and XOFF characters in the received data
- AUX:INBAND\_FLOW?** requests the current status of in-band flow control (on or off)
- AUX:INBAND\_FLOW:[XON|XOFF] (#Hnn)** specify the XON or XOFF characters for in-band flow control in hexadecimal format. #H indicates that the code immediately following is in the hexadecimal format; nn is the actual hexadecimal code (range: 00 to FF)
- AUX:INBAND\_FLOW:[XON|XOFF]?** requests the current XON or XOFF characters

This remote control command is identical in function to **auxiliary function 9** when the FIREBERD is controlled from the front panel.

Example:

- >AUX:INBAND\_FLOW?** requests the current state of in-band flow control  
OFF in-band flow control is off
- >AUX:INBAND\_FLOW ON** turn in-band flow control on
- >AUX:INBAND\_FLOW XON?** requests the current XON character  
#H0D 0D is the current XON character
- >AUX:INBAND\_FLOW:XON #HFF** change the XON character to FF
- >AUX:INBAND\_FLOW XOFF?** requests the current XOFF character  
#HFF FF is the current XOFF character
- >AUX:INBAND\_FLOW:XOFF #H0A** change the XOFF character to 0A

---

**IN\_USE**

---

**Auxiliary Functions In Use****command/query**

- AUX:IN\_USE?** requests the current auxiliary functions in use. Requests whether auxiliary functions 1 to 10 and 12 are in use or in their default states. This remote control command features 10 fields, one for each active auxiliary function as follows:

Field 1: GEN_CLK_POL	Field 6: RCV_CKL_SEL
Field 2: RCV_CLK_POL	Field 7: OUT_BND_FLW
Field 3: ACT_SYN_LOS	Field 8: IN_BND_FLW
Field 4: SINGLE_XMIT	Field 9: SYN_LOS_THR
Field 5: GEN_DAT_INV	Field 10: FRAME_RELAY

**AUX:IN\_USE:CLEAR** set the auxiliary functions to their defaults

**NOTE:** Auxiliary function 5 is not currently in use.

When in the default states, a 0 appears in the field instead of the auxiliary function name.

This remote control command is identical in function to **auxiliary function 99** when the FIREBERD is controlled from the front panel.

Example:

>**AUX:IN\_USE?** requests the current auxiliary functions in use  
 0,RCV\_CLK\_POL,0,0,0,0,  
 OUT\_BAND\_FLW,0,0 receiver clock polarity and out-of-band flow control are in use

>**AUX:IN\_USE:CLEAR** set the auxiliary functions to their defaults

## OUTBAND\_FLOW

**Out-of-Band Flow Control** **command/query**

**AUX:OUTBAND\_FLOW [OFF|ON]** enable or disable out-of-band flow control

**AUX:OUTBAND\_FLOW?** requests the current status of out-of-band flow control (on or off)

**AUX:OUTBAND\_FLOW:  
 [TR|DM|RS|CS|RR]  
 [OFF|ON]** turn individual signaling leads on or off. These signaling leads can be enabled even when out-of-band flow control is OFF.

**AUX:OUTBAND\_FLOW:  
 [TR|DM|RS|CS|RR]?** requests the status of the individual signaling leads

Out-of-band flow control is a function which allows data transmission to take place only when certain signaling leads are placed in the ON state (i.e., enabled).

This remote control command is identical in function to **auxiliary function 8** when the FIREBERD is controlled from the front panel.

Note that RS-449-standard signal names are used in this command. The relationship between RS-449 and RS-232 signal names is as follows:

<u>RS-449</u>	<u>RS-232</u>
TR <sup>†</sup>	DTR <sup>†</sup>
DM <sup>*</sup>	DSR <sup>*</sup>
RS <sup>†</sup>	RTS <sup>†</sup>
CS <sup>*</sup>	CTS <sup>*</sup>
RR <sup>*</sup>	RLSD <sup>*</sup>

<sup>†</sup> Received by DCE

<sup>\*</sup> Received by DTE

Example:

>AUX:OUTBAND_FLOW? OFF	requests the current state of out-of-band flow control out-of-band flow control is off
>AUX:OUTBAND_FLOW ON	turn out-of-band flow control on
>AUX:OUTBAND_FLOW:TR? >OFF	requests the current status of the TR signaling lead the TR signaling lead is off
>AUX:OUTBAND_FLOW:TR ON	turn the TR signaling lead on
>AUX:OUTBAND_FLOW:CS? >ON	requests the current status of the CS signaling lead the CS signaling lead is on
>AUX:OUTBAND_FLOW:CS OFF	turn the CS signaling lead off
>AUX:OUTBAND_FLOW:DM? >OFF	requests the current status of the DM signaling lead the DM signaling lead is off
>AUX:OUTBAND_FLOW:DM ON	turn the DM signaling lead on

## PATTERN

### User Message Selection

command/query

<b>AUX:PATTERN</b> [USER1 USER2 USER3] 1:7 3 IN24 T1-1 T1-2 T1-3 T1-4   T1-5 T1-6 T1-MW DDS-1 DDS-2   DDS-3 DDS-4 DDS-5 DDS-6 1020HZ]	select a data pattern
<b>AUX:PATTERN:DATA</b> [USER1 USER2 USER3], “(string)”	create a data pattern and assign it to the USER message specified. Spaces must be inserted between each byte in the data pattern
<b>AUX:PATTERN:APPEND</b> [USER1 USER2 USER3], “(string)”	append string to the specified USER message
<b>AUX:PATTERN:INSERT</b> [USER1 USER2 USER3], (position),“(string)”	insert string into USER message beginning at the byte position specified
<b>AUX:PATTERN:REPLACE</b> [USER1 USER2 USER3], (position),“(string)”	replace string in the USER message beginning at the byte position specified
<b>AUX:PATTERN:DELETE</b> [USER1 USER2 USER3], (position),(bytes)	delete a number of bytes in the string of the USER message beginning at the byte position specified



<b>AUX:PATTERN?</b>	requests the currently selected pattern
<b>AUX:PATTERN:SIZE?</b> <b>[USER1 USER2 USER3]</b>	requests the length of the user pattern specified
<b>AUX:PATTERN:DATA?</b> <b>[USER1 USER2 USER3]</b>	requests the current pattern assigned to the USER message specified

This series of commands and queries is dedicated to the creation and selection of user patterns and messages.

The **AUX:PATTERN** command is used to select from a series of predetermined patterns that are supplemental to those available through the **DATA** switch: 1:7, 3-in-24, T1-1 to T1-6, T1-mW, T1-DALY, 1020Hz, and DDS-1 to DDS-6. This command is also used to select one of three user-created patterns of up to 2048 characters each: USER1 to USER3.

Certain combinations of synthesizer, data pattern, and timing mode settings are not valid. If the new pattern setting is invalid, a contention error appears in the error buffer and the previous pattern setting is retained.

**NOTE:** When entering a lengthy user-created pattern, the number of characters that can be entered on any given line is limited in RS-232 terminal mode. If the pattern to be entered is longer than a single line, hit the **RETURN** or **ENTER** key before the bytes entered exceed line space; in such instances, a new prompt appears on the line immediately following and you may continue entering bytes until pattern entry is completed. Note that the entire pattern must always be enclosed with quotation marks.

This remote control command is identical in function to **auxiliary function 41** when the FIREBERD is controlled from the front panel.

Example:

<b>&gt;AUX:PATTERN:DATA? USER1</b> "48 45 4C 4C 4F"	requests the current user-created pattern assigned to USER1 the USER1 pattern is HELLO in ASCII
<b>&gt;AUX:PATTERN:DATA USER2, "48 49"</b>	set USER2 pattern to HI in ASCII
<b>&gt;AUX PATTERN:DATA? USER2</b> "48 49"	requests the current user-created pattern assigned to USER2 the USER2 pattern is 48 49
<b>&gt;AUX:PATTERN:APPEND USER2,"AA BB 40"</b>	append three bytes to USER2
<b>&gt;AUX:PATTERN:DATA? USER2</b> "48 49 AA BB 40"	requests the new USER2 pattern the new bytes have been appended to USER2
<b>&gt;AUX:PATTERN:REPLACE USER2,3,"CC DD"</b>	replace current USER2 string with CC DD starting at position 3
<b>&gt;AUX:PATTERN:DATA? USER2</b> "48 49 CC DD 40"	requests the new USER2 message
<b>&gt;AUX:PATTERN:INSERT USER2,3,"00 01"</b>	insert 00 and 01 in USER2 starting at position 3
<b>&gt;AUX:PATTERN:DATA? USER2</b> "48 49 00 01 CC DD 40"	requests the new USER2 pattern

> <b>AUX:PATTERN:DELETE USER2,3,5</b>	delete five bytes from the USER2 beginning at position 3
> <b>AUX:PATTERN:DATA? USER2</b> "48 49"	requests the new USER2 pattern
> <b>AUX:PATTERN:SIZE? USER2</b> 2	requests the current size of the USER2 pattern the USER2 message size is 2 bytes

---

## PRGM\_PATTERN

---

### Programmable Data Pattern

command/query

**AUX:PRGM\_PATTERN "bit pattern"** set a 3- to 24-bit programmable pattern. This data pattern is used when the **DATA** switch is in the PRGM position. The (bit pattern) can be any sequence of 3 to 24 ones (1's) and/or zeros (0's), corresponding to the desired binary bit pattern, with the left-most bit transmitted first.

**AUX:PRGM\_PATTERN?** requests current bit pattern

This remote control command is identical in function to **auxiliary function 33** when the FIREBERD is controlled from the front panel.

Example:

>**AUX:PRGM\_PATTERN "11010011"** set the programmable pattern to 11010011

>**AUX:PRGM\_PATTERN?** requests the current programmable pattern

"11010011"

---

## RCV\_CLK\_POL

---

### Receiver Clock Polarity

command/query

**AUX:RCV\_CLK\_POL**  
**[AUTO|NORMAL|INVERT]** set receiver clock polarity. AUTO automatically detects, corrects, and maintains receiver clock polarity while error analysis is in progress; NORMAL sets receiver clock polarity to the current interface standard; INV sets receiver clock polarity to the inverse of the interface standard. AUTO is the default

**AUX:RCV\_CLK\_POL?** requests the current status of receiver clock polarity

## AUXILIARY COMMANDS

This remote control command is identical in function to **auxiliary function 2** when the FIREBERD is controlled from the front panel.

Example:

```
>AUX:RCV_CLK_POL AUTO          set automatic receiver clock polarity
>AUX:RCV_CLK_POL?              then display its status
AUTO
```

### RCV\_CLK\_SEL

---

Select a Receiver Clock Source command/query

**AUX:RCV\_CLK\_SEL [AUTO|ST|TT]** select a receiver clock source. ST selects Send Timing (a DCE output); TT selects Terminal Timing (a DCE input); AUTO automatically selects ST if TT is not present in the current interface. AUTO is the default selection

**AUX:RCV\_CLK\_SEL?** requests the currently selected clock source

This remote control command is identical in function to **auxiliary function 7** when the FIREBERD is controlled from the front panel.

Example:

```
>AUX:RCV_CLK_SEL AUTO          set automatic selection of the receiver clock
>AUX:RCV_CLK_SEL?              display the receiver clock selection status
AUTO
```

### RS232

---

RS-232 Printer/Remote Control Configuration command/query

**AUX:RS232:BAUD [110|300|600|1200|2400|4800|9600]** set baud rate

**AUX:RS232:DATA\_BITS [7|8]** set data bits

**AUX:RS232:PARITY [ODD|EVEN|NONE]** set parity bit

**AUX:RS232?** requests the current baud, data, and parity settings

**AUX:RS232:BAUD?** requests the current baud rate

**AUX:RS232:DATA\_BITS?** requests the current data bits

**AUX:RS232:PARITY?** requests the current parity

This series of commands and queries are dedicated to RS-232 printer/remote control configuration.

This remote control command is identical in function to **auxiliary function 38** when the FIREBERD is controlled from the front panel.

**NOTE:** These commands cannot change these parameters when RS-232 is used via remote control.

Example:

> <b>AUX:RS232:BAUD?</b> 9600	requests the current baud rate the current baud rate is 9600
> <b>AUX:RS232:BAUD 300</b>	change the baud rate to 300
> <b>AUX:RS232:PARITY?</b> EVEN	requests the current parity setting parity is even
> <b>AUX:RS232:PARITY ODD</b>	change the parity to odd
> <b>AUX:RS232?</b> 300, 7, ODD	requests the current baud, data, and parity settings

## SINGLE\_XMIT

Transmit a Single Pattern or Message

command/query

**AUX:SINGLE\_XMIT [OFF|ON]** enable single or continuous transmission. OFF allows data to be transmitted continuously; ON allows only one pattern or message to be transmitted during a single test. OFF is the default selection

**AUX:SINGLE\_XMIT?** requests the current status

This remote control command is identical in function to **auxiliary function 4** when the FIREBERD 6000 is controlled from the front panel.

Example:

> <b>AUX:SINGLE_XMIT ON</b>	enable single transmit mode
> <b>AUX:SINGLE_XMIT?</b> ON	display the current status of this activity

## SITE\_ID

Site Identification

command/query

**AUX:SITE\_ID "(site identifier)"** set a site identifier. The (site identifier) may be from 1 to 10 alphanumeric characters in length, and is always placed between quotation marks

**AUX:SITE\_ID?** requests the current site identifier

## AUXILIARY COMMANDS

This remote control command is identical in function to **auxiliary function 34** when the FIREBERD is controlled from the front panel.

Example:

>**AUX:SITE\_ID?** requests the current site ID  
"Alpha" alpha is the current site ID

>**AUX:SITE\_ID "BETA2"** change the current site ID to BETA2

>**AUX:SITE\_ID?** requests the current site ID  
"BETA2"

## SYNCLOSS\_ACT

### Receiver Action on Synchronization Loss

command/query

#### **AUX:SYNCLOSS\_ACT** **[CLEAR|HALT|CONT]**

set the action on synchronization loss. CLEAR resets all results counters and restarts the test when synchronization is reacquired. HALT freezes all test results for the duration of the synchronization loss; the test continues when synchronization is reacquired. CONT allows test results to accumulate while the receiver attempts to reacquire synchronization; this selection is only valid in SYNC and RECOVD timing modes. CLEAR is the default selection

**AUX:SYNCLOSS\_ACT?** requests the current action on synchronization loss

This remote control command is identical in function to **auxiliary function 3** when the FIREBERD is controlled from the front panel.

Example:

>**AUX:SYNCLOSS\_ACT CLEAR** restart the test after reacquiring receiver synchronization

>**AUX:SYNCLOSS\_ACT?** display the current action on receiver synchronization loss  
CLEAR

## SYNCLOSS\_THR

### Synchronization Loss Error Threshold

command/query

#### **AUX:SYNCLOSS\_THR** **[LOW|MED|HIGH]**

set the synchronization loss error rate threshold required for the FIREBERD to declare a loss of synchronization. LOW sets the threshold to 100 errors in 1000 bits; MED sets the threshold to 250 errors in 1000 bits; HIGH sets the threshold to 20,000 errors in 100,000 bits

**AUX:SYNCLOSS\_THR?** requests the current synchronization loss error rate threshold

This remote control command is identical in function to **auxiliary function 10** when the FIREBERD is controlled from the front panel.

Example:

```
>AUX:SYNCLOSS_THR MED           set medium sync loss threshold

>AUX:SYNCLOSS_THR?
MED                             requests current sync loss threshold
```

## TIME

### Set and Display Time

command/query

**AUX:TIME "(time)"** set the time of day. The time is entered in 24-hour format, and is always placed between quotation marks; seconds are always set to 0

**AUX:TIME?** requests the time of day

This remote control command is identical in function to **auxiliary function 60** when the FIREBERD is controlled from the front panel.

Example:

```
>AUX:TIME "13:45"               set the time of day to 1:45 P.M.

>AUX:TIME?
"13:45:00"                       requests the current time of day
```

## USR\_SYNC\_THR

### User Message Sync Acquisition Threshold

command/query

**AUX:USR\_SYNC\_THR [PATTERN|BYTES]** set the synchronization acquisition threshold PATTERN sets the length of the selected user message; BYTES sets the length by a specific number of bytes

**AUX:USR\_SYNC\_THR?** requests the byte length of the synchronization acquisition threshold

**AUX:USR\_SYNC\_THR:BYTES (number)** set the byte length of the synchronization acquisition threshold, if threshold is set to BYTES. The valid range is 10-2048 bytes

**AUX:USR\_SYNC\_THR:BYTES?** requests the byte length of the synchronization acquisition threshold

## AUXILIARY COMMANDS

---

This remote control command is identical in function to **auxiliary function 45** when the FIREBERD is controlled from the front panel.

Example:

- |   |  |
|---|--|
| > <b>AUX:USR_SYNC_THR</b> BYTES         | set the synchronization acquisition threshold to the length specified in the command immediately following |
| > <b>AUX:USR_SYNC_THR:BYTES</b> 256     | set the synchronization threshold to 256 bytes   |
| > <b>AUX:USR_SYNC_THR:BYTES?</b><br>256 | display the length in bytes of the synchronization acquisition threshold                                   |

## COMMON COMMANDS

The IEEE-488.2 Standard defines a set of commands and queries that should be common to all instruments. Some commands are mandatory, while others are optional.

The common commands and queries accepted by the FIREBERD 6000 are:

Commands	Queries
*CLS	
*ESE	*ESE?
	*ESR?
	*IDN?
	*IST?
*OPC	*OPC?
	*OPT?
*PRE	*PRE?
*PSC	*PSC?
*RCL	
*RST	
*SAV	
*SRE	*SRE?
	*STB?
*TRG	
	*TST?
*WAI	

### \*CLS

#### Clear Status

command

**\*CLS** clears the Standard Event Status Register, including the device-defined print queue and the error buffer. The **\*CLS** command does not clear the output queue if it is part of a <program message> containing a query. This means the Message Available (MAV) bit of the Status Register may not be cleared

Example:

>**\*CLS** clear the status register, queues, and buffers

>**\*ESR?** read the register  
0 status registers cleared



**\*ESE**

**Event Status Enable**

**command/query**

**\*ESE** set the bits in the Standard Event Status Enable Register. The value of the bits determine which bits in the Standard Event Status Register are enabled. When a bit in the Standard Event Status Register and its corresponding enable bit are set, the Event Status Bit 5 (ESB) of the Status Register is also set

**\*ESE?** return the status of the bits in the Standard Event Status Enable Register. The value returned is the total bit weight of all the bits that are enabled when the byte is read. Table 4-2 offers information on the bits in the Standard Event Status Enable Register

(See the **\*ESR** and **\*STB** commands, found later in this section for additional information.)

The **\*ESE?** query returns the status of the bits in the Standard Event Status Enable Register.

**Table 4-2  
Standard Event Status Enable Register**

Bit:	Weight:	Enables:
7	128	PON - Power On
6	64	URQ - User Request
5	32	CME - Command Error
4	16	EXE - Execution Error
3	8	DDE - Device Dependent Error
2	4	QYE - Query Error
1	2	RQC - Request Control
0	1	OPC - Operation Complete

Example:

**>\*ESE 32** enable bit 5 (Command Error) of the register

**>\*ESE?** requests the enabled bit(s) in the register  
32

**\*ESR**

**Event Status Register**

**query**

**\*ESR?** return the current contents of the Standard Event Status Register. The value returned is the total weight of all the bits that are enabled when the byte is read. After reading the register, this query is cleared. Table 4-3 offers information on each bit in this register

(See the **\*SRE** and **\*OPC** commands for additional information.)

**Table 4-3**  
**Standard Event Status Register**

Bit:	Weight:	Bit Name:	Condition:
7	128	PON	0 = Not powered-on since last reading. 1 = Powered-on since last reading.
6	64	URQ	Not defined. Always 0.
5	32	CME	Set to 1 when a Command error occurs.
4	16	EXE	Set to 1 when an Execution error occurs.
3	8	DDE	Not defined. Always 0.
2	4	QYE	Set to 1 when a Query error occurs.
1	2	RQC	Request control - not used - always 0.
0	1	OPC	Set to 1 when a program message containing the *OPC command is executed.

Example:

```
>*ESR?          read the Event Status Register
32              a Command error occurred
```

#### \*IDN

#### Identification Query

query

\*IDN? return FIREBERD 6000 identification information, as follows: manufacturer, model, serial number (always 0), and software revision

The \*IDN? query must be the last query in a program. Queries following \*IDN? in a program message are ignored.

Example:

```
>*IDN?          return the FIREBERD identification information
Telecommunications Techniques Corporation, Fireberd 6000, 0, K
```

#### \*IST

#### Individual Status

query

\*IST? return the Individual Status message (IST), which determines how the FIREBERD 6000 responds to a parallel poll

When the controller issues a parallel poll, it sends a sense bit. The FIREBERD respond to the parallel poll only if the IST (Individual Status) value matches the sense of the serial poll. The value of the IST message is determined by the Status Byte Register and the Parallel Poll Enable Register (See the \*PRE and \*STB commands for additional information)

Example:

```
>*IST?          return the Individual Status message
0
```

**\*OPC**

**Operation Complete**

**command/query**

**\*OPC** set the Operation Complete (OPC) bit of the Standard Event Status Register to a value of 1 when all pending device operations are completed

**\*OPC?** return the status of the OPC bit. The **\*OPC?** query places an ASCII "1" in the output queue when all pending device operations are completed (i.e., no operations are pending)

Example:

**>CONFIG:SELF\_LOOP ON;\*OPC** set the OPC bit to a value of 1 after self-loop mode has been established

**>CONFIG:SELF\_LOOP ON;\*OPC?** returns a 1 after self-loop mode has been established

1

**\*OPT**

**Option Identification**

**query**

**\*OPT?** requests the options that are installed in the FIREBERD 6000. Options are reported by field, as follows:

- Field 1: G.703 JIT (G.703 Jitter)
- Field 2: JIT\_S\_A (Jitter Spectrum Analysis)
- Field 3: DS1\_WIDEBAND\_JIT (DS1 Wideband Jitter)
- Field 4: DS1\_JIT\_GEN (DS1 Jitter Generator)
- Field 5: CLK\_RECOV (Clock Recovery)
- Field 6: IEEE488 (IEEE-488 Interface)
- Field 7: REMOTE (Remote Control FIREBERD)
- Field 8: SYNC\_USER\_MSG (Synchronous User Message)
- Field 9: T1\_403\_PRM (ANSI T1.403 Performance Report Message)
- Field 10: FRAME\_RELAY (Frame Relay)
- Field 11: Reserved for future use

When an option is not installed, a 0 appears in place of the option name.

Example:

**>OPT?** identify the options that are installed in the FIREBERD  
 0,0,0,0,0,IEEE488,0,SYNC\_USER\_MSG,0,0,0

**\*PRE****Parallel Poll Enable****command/query****\*PRE**

set the bits in the Parallel Poll Enable Register. The value of these bits determine which bits of the Status Byte will set the Individual Status (IST) message. The IST message is enabled whenever a bit in the Parallel Poll Enable Register and the corresponding bit in the Status Byte Register are set. The IST message is used to determine the response to a parallel poll

**\*PRE?**

return the status of the bits in the Parallel Poll Enable Register. The value returned is the total weight of all the bits that are enabled when the byte is read. Table 4-4 offers information on each bit in the Parallel Poll Enable Register

(See the **\*STB** and **\*IST** commands for more information.)

**Table 4-4**  
**Parallel Poll Enable Register**

Bit:	Weight:	Enables this bit to set IST:
7	128	Not Defined.
6	64	MSS - Master Status Summary.
5	32	ESB - Event Status Bit.
4	16	MAV - Message Available.
3	8	IEB - Interface Event Bit.
2	4	LEB - Line Event Bit.
1	2	PAV - Print Available.
0	1	EAV - Error Message Available.

Example:

```
>*PRE 16          enable MAV to set IST
>*PRE?           read current value of the Parallel Poll Enable Register
16
```

**\*PSC****Power-On Status Clear****command/query****\*PSC**

clear all Status Enable Registers at FIREBERD 6000 power-on. When set to 1, the FIREBERD automatically clears all Status Enable Registers at power-on, which prevents the instrument from generating a service request; when set to 0, the FIREBERD does not clear the Status Enable Registers

**\*PSC?**

return the current status of the activity

Example:

>\*PSC 0 preserve all Status Enable Register settings at power-on

>\*PSC?  
0 return the current setting of the bit

**\*RCL**

**Recall Stored Test Set-ups**

**command**

**\*RCL** recall a stored test set-up for immediate use by the FIREBERD 6000. This command is identical to the **RECALL** function of the FIREBERD 6000 **MENU** switch. Note, however, that the remote control and printer settings specified in auxiliary function 11 are not changed; neither are the RS-232 settings in auxiliary functions 38 or the Status Clear bit (see the **\*PSC** command.) This ensures that remote control operation can continue after the **\*RCL** command is issued. Valid program numbers are 0-9

Example:

>\*RCL 3 recall stored test set-up number 3

**\*RST**

**Reset**

**command**

**\*RST** reset the FIREBERD 6000 to its factory-default settings

Example:

>\*RST set the FIREBERD 6000 to its factory-default settings

**\*SAV**

**Save**

**command**

**\*SAV n** save a stored test set-up (n = 0-9). This command is similar in function to the **STORE** activity on the FIREBERD 6000 **MENU** switch. Valid program numbers are 0-9

Example:

>\*SAV 3 save current configuration as test set-up number 3

**\*SRE****Service Request Enable****command/query****\*SRE**

set the bits in the Service Request Enable Register. The value of these bits determine which bits in the Service Request Enable are enabled. When a bit in the Status Byte Register and its corresponding enable bit are set, the Master Summary Status (MSS) bit of the Status Register is also set. The MSS bit represents the summary of all the status registers, queues and buffers. When set to 1, a service request (SRQ) is signaled by the FIREBERD 6000 when operating under IEEE-488 remote control

**\*SRE?**

return the status of the bits in the Service Request Enable Register. The value returned is the total weight of all the enabled bits at the time the byte is read. Table 4-5 offers information on the bits in the Service Request Enable Register

(See the **\*STB** command and Section 4.7 for more information.)

**Table 4-5**  
**Service Request Enable Register**

Bit:	Weight:	Enables:
7	128	Not defined. Always 0.
6	64	Not defined. Always 0.
5	32	ESB - Event Status Bit.
4	16	MAV - Message Available.
3	8	IEB - Interface Event Bit.
2	4	LEB - Line Event Bit.
1	2	PAV - Print Available.
0	1	EAV - Error Message Available.

Example:

> **\*SRE 16**

bit 4 MAV (Message Available) sets the MSS bit

> **\*SRE?**

read the SRE register

16

FIREBERD responds with the current value of the SRE register

**\*STB**

**Status Byte**

**query**

**\*STB?**

return the current value of the FIREBERD 6000 status byte. The value returned is the total weight of all the bits that are enabled when the byte is read. The Status Byte Register contains the same value that is read by a serial poll over the IEEE-488 bus. Table 4-6 offers information on each bit in the Status Byte Register

(See the **\*SRE** command for more information.)

**Table 4-6  
Status Byte Register**

Bit:	Weight:	Enables:
7	128	Not defined. Always 0.
6	64	MSS - Master Status Summary.
5	32	ESB - Event Status Bit.
4	16	MAV - Message Available.
3	8	IEB - Interface Event Bit.
2	4	LEB - Line Event Bit.
1	2	PAV - Print Available.
0	1	EAV - Error Message Available.

Example:

```
> *STB?          read the FIREBERD Status Byte Register
33              33 indicates that the ESB and EAV bits are set
```

**\*TRG**

**Trigger**

**command**

**\*TRG**

executes a device trigger which clear all results. This command is identical to the **RESULT:CLEAR** command, and performs the same function as a device trigger over the IEEE-488 bus

Example:

```
> *TRG          FIREBERD 6000 clears results
```

**\*TST****Self-Test****query****\*TST?**

requests self-test results. If the **\*TST** query returns a value of 0, no problems were encountered; if a value other than 0 is returned, it indicates that problems occurred during the self-test (e.g., ROM failure, RAM failure, NOVRAM loss, etc.). Table 4-7 offers information on the value returned for the Self Test Byte value

Example:

```
>*TST?
0
```

requests on the last self-test  
self-test was successful

**Table 4-7**  
**Self Test Bit Response Value**

Weight:	Self-Test Failure:
1	ROM Failure.
2	RAM Failure.
4	NOVRAM Failure.
8	NOVRAM Lost.
16	Real-Time Clock Failure.

**\*WAI****Wait****command****\*WAI**

delay execution of any commands until all operations are complete. The **\*WAI** command causes all previous commands to complete before executing any other commands or queries

**NOTE:**

Since the FIREBERD executes all commands serially, the **\*WAI** command does not need to be used. However, because it is a required IEEE-488-standard command, it is included in the Common Command set.

Example:

```
>CONFIG:GEN_CLK; SYNTH*WAI
```

enables all commands prior to **\*WAI** to be executed prior to completing those that were issued after this command was invoked



**CONFIGURATION COMMANDS**

The FIREBERD 6000 features a set of commands and queries that can remotely configure the instrument switches and LEDs. These commands and queries are:

Commands	Queries
CONFIG:ANA_MODE	CONFIG:ANA_MODE?
CONFIG:CHAR_FORMAT:DATA_BITS	CONFIG:CHAR_FORMAT?
CONFIG:CHAR_FORMAT:PARITY	CONFIG:CHAR_FORMAT:DATA_BITS?
CONFIG:CHAR_FORMAT:STOP_BITS	CONFIG:CHAR_FORMAT:PARITY?
CONFIG:DM	CONFIG:CHAR_FORMAT:STOP_BITS?
CONFIG:DSR	CONFIG:DM?
CONFIG:DTR	CONFIG:DSR?
CONFIG:ERR_INSERT	CONFIG:DTR?
CONFIG:FREQ	CONFIG:ERR_INSERT?
CONFIG:GEN_CLK	CONFIG:FREQ?
CONFIG:LOOP	CONFIG:GEN_CLK?
CONFIG:PATTERN	CONFIG:PATTERN?
CONFIG:RLSD	CONFIG:RLSD?
CONFIG:RR	CONFIG:RR?
CONFIG:RTS	CONFIG:RTS?
CONFIG:SELF_LOOP	CONFIG:SELF_LOOP?
CONFIG:TEST_INT	CONFIG:TEST_INT?
CONFIG:TIMING_MODE	CONFIG:TIMING_MODE?
CONFIG:TPZ	CONFIG:TPZ?

**ANA\_MODE**

**Analysis Mode** **command/query**

**CONFIG:ANA\_MODE**  
**[SINGLE|CONTINUOUS]** set the FIREBERD analysis mode. In SINGLE analysis mode, the actual length of the test is determined by the **CONFIG:TEST\_INT** remote control command; in CONTINUOUS analysis mode, a test runs indefinitely and continues to accumulate test results

**CONFIG:ANA\_MODE?** requests the current analysis mode

This remote control command is identical in function to the **ANALYSIS MODE** switch, located on the FIREBERD 6000 front panel.

Example:

>**CONFIG:ANA\_MODE?**  
 SINGLE requests the current mode of analysis  
 the current analysis mode is SINGLE

>**CONFIG:ANA\_MODE CONTINUOUS** change the analysis mode to CONTINUOUS

---

**CHAR\_FORMAT**

---

**Asynchronous Character Format**

command/query

<b>CONFIG:CHAR_FORMAT: DATA_BITS [5 6 7 8]</b>	set the number of data bits*
<b>CONFIG:CHAR_FORMAT: PARITY [ODD EVEN NONE]</b>	set the parity
<b>CONFIG:CHAR_FORMAT: STOP_BITS [1 1.5 2]</b>	set the number of stop bits
<b>CONFIG:CHAR_FORMAT: DATA_BITS?</b>	requests the current number of data bits
<b>CONFIG:CHAR_FORMAT: PARITY?</b>	requests the current parity setting
<b>CONFIG:CHAR_FORMAT: STOP_BITS?</b>	requests the current number of stop bits
<b>CONFIG:CHAR_FORMAT?</b>	requests the current data bit, parity, and stop bit settings

This series of commands and queries is dedicated to selection of the asynchronous character format.

This remote control command is identical in function to the CHAR\_FORMAT category of the FIREBERD 6000 MENU switch.

- \* 5=BCD
- 6=BAUDOT
- 7=ASCII
- 8=EBCDIC

Example:

<b>&gt;CONFIG:CHAR_FORMAT? 7, ODD, 1.5</b>	requests the data bit, parity, and stop bit settings
<b>&gt;CONFIG:CHAR_FORMAT:PARITY EVEN</b>	change the parity setting to even
<b>&gt;CONFIG:CHAR_FORMAT:PARITY? EVEN</b>	requests the new parity setting

**DM**

---

**DM Line Control** **command/query****CONFIG:DM [ON|OFF]** sets the state of the RS-449 DM signaling lead (i.e., ON or OFF). It is only valid when the FIREBERD 6000 is operating in DCE mode**CONFIG:DM?** requests the current state of the DM signaling lead

Example:

**>CONFIG:DM?** requests the current state of the DM signaling lead  
OFF**>CONFIG:DM ON** turn the DM signaling lead**DSR**

---

**DSR Line Control** **command/query****CONFIG:DSR [ON|OFF]** sets the state of the RS-232 DSR signaling lead (i.e., ON or OFF). It is only valid when the FIREBERD 6000 is operating in DCE mode**CONFIG:DSR?** requests the current state of the DSR signaling lead

Example:

**>CONFIG:DSR?** requests the current state of the DSR signaling lead  
ON**>CONFIG:DSR OFF** turn the DSR signaling lead off**DTR**

---

**DTR Line Control** **command/query****CONFIG:DTR [ON|OFF]** sets the state of the DTR (for RS-232) or the TR (for RS-449) signaling lead (i.e., ON or OFF). It is only valid when the FIREBERD 6000 is operating in DTE mode**CONFIG:DTR?** requests the current state of the DTR signaling lead

Example:

**>CONFIG:DTR?** requests the current state of the DTR signaling lead  
OFF**>CONFIG:DTR ON** turn the DTR signaling lead on

**ERR\_INSERT**

**Logic Error Insertion**

**command/query**

**CONFIG:ERR\_INSERT [OFF|SINGLE|1.0E-3]** set error insertion status. OFF disables automatic error insertion; SINGLE causes a single error to be inserted into the generated data; 1.0E-3 causes one error to be inserted per 1000 bits of generated data

**CONFIG:ERR\_INSERT?** requests the current error insertion status

**NOTE:** Single error insertion terminates 1.0E-3 insertion, if it is in effect.

This remote control command is identical in function to the **ERROR INSERT** switch on the FIREBERD 6000 front panel.

Example:

- >**CONFIG:ERR\_INSERT OFF** turn off automatic error insertion
- >**CONFIG:ERR\_INSERT?** requests the current error insertion status  
OFF
- >**CONFIG:ERR\_INSERT 1.0E-3** enable automatic error insertion
- >**CONFIG:ERR\_INSERT SINGLE** insert a single error
- >**CONFIG:ERR\_INSERT?** requests the current error insertion status  
OFF  
the 1.0E-3 rate is terminated

**FREQ**

**Set Synthesizer Frequency**

**command/query**

**CONFIG:FREQ (frequency)** set the synthesizer frequency in kHz. The (frequency) can be any valid kHz value within the range of .05 kHz to 15000 kHz

**CONFIG:FREQ?** requests the current synthesizer frequency

This remote control command is identical in function to the SYNTH FREQ category of the FIREBERD 6000 **MENU** switch.

Certain combinations of synthesizer frequency, data pattern, and timing mode settings are not valid. If the FIREBERD new frequency setting is invalid, a contention error appears in the error buffer and the previous frequency setting is retained.

To reduce the possibility of an invalid configuration, the FIREBERD delays execution of this command until all other commands of the program message are read. The delayed commands are considered simultaneously and an error is flagged only if the final configuration is invalid.

Example:

- >**CONFIG:FREQ?** requests the current synthesizer frequency  
9.6
- >**CONFIG:FREQ 1544;** set the frequency synthesizer to 1544 kHz and timing mode to synchronous  
**TIMING\_MODE SYNC** this prevents a potential asynchronous frequency contention

**GEN\_CLK**

**Generator Clock Select**

**command/query**

**CONFIG:GEN\_CLK [SYNTH|INTF|BNC]** set the generator clock. SYNTH sets the FIREBERD built-in frequency synthesizer as the source of signal timing; INTF selects the clock originating from the network or the clock in the interface module as the source of signal timing; BNC selects an external timing source. If BNC is selected, the external timing source must be connected to the BNC connector labeled GEN CLK IN, on the FIREBERD 6000 rear panel

**CONFIG:GEN\_CLK?** requests the current generator clock setting

This remote control command is identical in function to the GEN CLK category on the FIREBERD 6000 **MENU** switch.

Example:

>**CONFIG:GEN\_CLK SYNTH** select the synthesizer as the source of signal timing

>**CONFIG:FREQ?** requests the current synthesizer frequency  
9.6

>**CONFIG:GEN\_CLK?** requests the current generator clock setting  
SYNTH

**LOOP**

**Generator Loop Codes**

**command**

**CONFIG:LOOP [UP|DOWN]** generate loop up or loop down codes for T1 interfaces or the DDS DS0A/B Interface. In such instances, loop code transmission is valid only when testing out-of-service. To send either loop code, the interface must be placed in either alternating or latching loopback mode

**NOTE:** The **CONFIG:LOOP DOWN** command should always be used at the end of any loopback test to remove the effect of loop-up code (transmitted by the **CONFIG:LOOP UP** command) on the circuit under test.

Example:

>**CONFIG:LOOP UP** generate loop up code  
Transmitting Loop Code  
> loop-up code transmission is successful

>**CONFIG:LOOP DOWN** loop down code is transmitted at the conclusion of the test to return the circuit to normal operation  
Transmitting Loop Code  
> loop-down code transmission is successful

## PATTERN

## Select a Data Pattern

command/query

**CONFIG:PATTERN [MARK|1:1|63|511|2047|2<sup>15</sup>-1|2<sup>20</sup>-1|2<sup>23</sup>-1|QRSS|PRGM|FOX|USER]** select a data pattern

**CONFIG:PATTERN?** return the current data pattern

The **CONFIG:PATTERN** command selects a data pattern to be generated by the FIREBERD. The data pattern selected may be any one of the following:

MARK	all Marks
1:1	alternating Mark and Space
63	63-bit pseudorandom pattern
511	511-bit pseudorandom pattern
2047	2047-bit pseudorandom pattern
2 <sup>15</sup> -1	2 <sup>15</sup> -1 pseudorandom pattern
2 <sup>20</sup> -1	2 <sup>20</sup> -1 pseudorandom pattern
2 <sup>23</sup> -1	2 <sup>23</sup> -1 pseudorandom pattern
QRSS	QRSS pattern
PRGM	programmable pattern
FOX	QUICK BROWN FOX message
USER	user-defined message

This remote control command is identical in function to the **DATA** switch on the FIREBERD 6000 front panel.

Section 2 of this manual describes all data patterns generated by the FIREBERD 6000.

Certain combinations of synthesizer frequency, data pattern, and timing mode settings are not valid. If the new pattern setting is invalid, a contention error appears in the error buffer and the previous pattern setting is retained.

To reduce the possibility of an invalid configuration, the FIREBERD delays execution of this command until all other commands of the program message are read. The delayed commands are considered simultaneously and an error is flagged only if the final configuration is invalid.

Example:

**>CONFIG:PATTERN?** requests the current data pattern  
511

**>CONFIG:PATTERN QRSS** select the QRSS data pattern

**RLSD****RLSD Line Control****command/query**

**CONFIG:RLSD [ON|OFF]** sets the state of the RS-232 RLSD signaling lead (i.e., ON or OFF). It is only valid when the FIREBERD 6000 is operating in DCE mode

**CONFIG:RLSD?** requests the current state of the RLSD signaling lead

Example:

>**CONFIG:RLSD?**  
ON requests the current state of the RLSD signaling lead

>**CONFIG:RLSD OFF** turn the RLSD signaling lead off

**RR****RR Line Control****command/query**

**CONFIG:RR [ON|OFF]** sets the state of the RS-449 RR signaling lead (i.e., ON or OFF). It is only valid when the FIREBERD 6000 is operating in DCE modes

**CONFIG:RR?** requests the current state of the RR signaling lead

Example:

>**CONFIG:RR?**  
OFF requests the current state of the RR signaling lead

>**CONFIG:RR ON** turn the RLSD signaling lead on

**RTS****RTS Line Control****command/query**

**CONFIG:RTS [ON|OFF]** sets the state of the RS-232 RTS or the RS-449 signaling lead (i.e., ON or OFF). It is only valid when the FIREBERD 6000 is operating in DTE mode

**CONFIG:RTS?** requests the current state of the RTS signaling lead

Example:

>**CONFIG:RTS?**  
ON requests the current state of the RTS signaling lead

>**CONFIG:RTS OFF** turn the RTS signaling lead off

**SELF\_LOOP**

**Self-Loop Select** **command/query**

**CONFIG:SELF\_LOOP [ON|OFF]** sets the FIREBERD self-loop status

**CONFIG:SELF\_LOOP?** requests the current self-loop state

This remote control command is identical in function to the **SELF LOOP** switch on the FIREBERD 6000 front panel.

Example:

>**CONFIG:SELF\_LOOP?** requests the current self-loop state  
 OFF self-loop is OFF

>**CONFIG:SELF\_LOOP ON** turn self-loop ON

**TEST\_INT**

**Select Test Interval** **command/query**

**CONFIG:TEST\_INT ["1.0E4"|"1.0E5"|"1.0E6"|"1.0E7"|"1.0E8"|"1.0E9"|"1.0E10"]("hh:mm:ss")** select the number of bits in the test interval or select a timed test interval when SINGLE analysis mode is selected using the **CONFIG:ANA\_MODE** command. This interval may be a number of bits within the range 1.0E-4 to 1.0E-10, and must be placed within quotation marks. The test interval may also be a time period, expressed in hours, minutes, and seconds within quotation marks

**CONFIG:TEST\_INT?** requests the current test interval

This remote control command is identical in function to the TEST INTERVAL category of the FIREBERD 6000 **MENU** switch.

Example:

>**CONFIG:TEST\_INT?** requests the current test interval  
 "1.0E6" the current test interval is 1.0E6 bits

>**CONFIG:TEST\_INT "00:10:00"** set a timed test interval of 10 minutes

>**CONFIG:TEST\_INT?** requests the current test interval  
 "00:10:00"



**TIMING\_MODE**

Select Timing Mode

command/query

**CONFIG:TIMING\_MODE**  
**[SYNC|ASYNC|RECOVD]**

select a timing mode. SYNC selects synchronous timing; ASYNC selects asynchronous timing; RECOVD selects recovered timing. Each is discussed in detail in Section 2 of this manual

**CONFIG:TIMING\_MODE?**

requests the currently selected timing mode. When the current interface does not require a timing mode setting, the message N/A is returned

This remote control command is identical in function to the **TIMING MODE** switch on the FIREBERD 6000 front panel.

Certain combinations of synthesizer frequency, data pattern, and timing mode settings are not valid. If the new timing mode setting is invalid, a contention error appears in the error buffer and the previous timing mode setting is retained.

To reduce the possibility of an invalid configuration, the FIREBERD delays execution of this command until all other commands of the program message are read. The delayed commands are considered simultaneously and an error is flagged only if the final configuration is invalid.

See Section 2 of this manual for a description of the invalid settings.

Example:

>**CONFIG:TIMING\_MODE?**  
SYNC

requests the current timing mode  
synchronous timing is currently selected

>**CONFIG:TIMING\_MODE ASYNC;**  
**FREQ 1.2**

change the current timing mode to asynchronous and frequency to 1200 baud.  
This avoids a potential asynchronous frequency contention

**TPZ**

Set State of Rear-Panel Test Point

command/query

**CONFIG:TPZ [HIGH|LOW]**

set the state of the rear-panel test point. HIGH sets the test point to +5 volts; LOW sets the test point to 0 volts

**CONFIG:TPZ?**

requests the state of the rear-panel test point

Example:

>**CONFIG:TPZ?**  
LOW

requests the current state of the rear-panel test point  
the rear-panel test point is at 0 volts

>**CONFIG:TPZ HIGH**

change the state of the rear-panel test point



**Selecting an Interface Installed in an ISU-2000**

To find out what modular interface is installed in a slot in an ISU-2000, the interface in the ISU-2000 must be selected before the FIREBERD can determine what interface is installed in the designated slot.

- INTF:ISU2000 [REMOTE|LOCAL]** sets the ISU2000 operating mode
- INTF:ISU2000?** requests the ISU2000 operating mode
- INTF:ISU2000:SELECT [1|2|3|4]** select the interface installed in the selected slot. The ISU menus first be configured for remote control for this command to be functional

Example:

- >INTF:ISU2000?** request the ISU operating mode
- LOCAL**
- >INTF:ISU2000 REMOTE** set the ISU to remote operating mode
- >INTF:ISU2000:SELECT 2** select the interface installed in slot 2 of the ISU2000

**INT232**

---

**Internal RS-232 Interface Control** **command/query**

- INTF:INT232 [DTE|DCE]** emulate DTE or DCE
- INTF:INT232:DCE:RI [ON|OFF]** control RI signal
- INTF:INT232:DCE:CTS [ON|OFF|AUTO]** control CTS signal
- INTF:INT232?** requests current emulation
- INTF:INT232:DCE:RI?** requests current RI signal status
- INTF:INT232:DCE:CTS?** requests current CTS signal status

This series of commands and queries enables remote control of the FIREBERD 6000 internal RS-232 Interface.

For more information on the RS-232 interface, refer to Section 2 of this manual.

Example:

- >INTF:INT232?** requests the current emulation
- DTE**
- >INTF:INT232 DCE** enable DCE emulation
- >INTF:INT232:DCE:RI?** requests the current RI signal status
- OFF**
- >INTF:INT232:DCE:RI ON** turn the RI signal on

**JITTER COMMANDS**

The FIREBERD 6000 features a set of commands that configure, operate, and query the status of its jitter generation and measurement capability.

The jitter commands and queries accepted by the FIREBERD 6000 are:

Commands	Queries
JITTER:FILTER	JITTER:FILTER?
	JITTER:GEN?
JITTER:GEN:AMP	JITTER:GEN:AMP?
JITTER:GEN:FREQ	JITTER:GEN:FREQ?
JITTER:GEN:MOD	JITTER:GEN:MOD?
JITTER:HITS_THRESH	JITTER:HITS_THRESH?
JITTER:MASK	JITTER:MASK?
JITTER:RANGE	JITTER:RANGE?
	JITTER:SA?
JITTER:SA:FREQ	JITTER:SA:FREQ?
JITTER:SA:GRAPH	
JITTER:SA:LIST	
JITTER:SA:SWEEP	JITTER:SA:SWEEP?

**FILTER**

**Select DS1 Jitter Bandwidth**

**command/query**

<b>JITTER:FILTER</b> <b>[FULL]&gt;8KHZ]</b>	select jitter bandwidth measurement criteria. FULL measures the entire jitter bandwidth; >8KHZ only measures jitter above 8 kHz
<b>JITTER:FILTER?</b>	requests how jitter is currently measured
Example:	
> <b>JITTER:FILTER?</b> FULL	requests the DS1 jitter bandwidth full jitter bandwidth is measured
> <b>JITTER:FILTER &gt;8KHZ</b>	set the 8 kHz jitter filter

**GEN**

**Jitter Generation**

**command/query**

<b>JITTER:GEN:MOD [OFF SINE </b> <b>SQUARE TRIANGLE RAMP </b> <b>EXT EXT1 EXT2]</b>	set jitter generator modulation. Using this command, these waveforms can be selected:
<b>OFF</b>	no modulation takes place
<b>SINE</b>	sine wave
<b>SQUARE</b>	square wave

<b>TRIANGLE</b>	triangle wave
<b>RAMP</b>	ramp wave
<b>EXT</b>	external waveform (DS1)
<b>EXT1</b>	external waveform using jitter generator band 1 (G.703)
<b>EXT2</b>	external waveform using jitter generator band 2 (G.703)

**JITTER:GEN:FREQ**  
**[(frequency)]UP|DOWN|**  
**SWEEP]**

set jitter generator frequency. FREQ (frequency) sets a fixed frequency between 10 Hz and 40 kHz; the fixed frequency is limited to not more than 4 significant digits. UP and DOWN raises or lowers the fixed frequency to the next higher or lower value on the list of 40 valid frequencies. SWEEP sweeps the jitter generator across the same 40 frequencies as the spectrum analyzer, permitting synchronization between both components

**JITTER:GEN:AMP**  
**[(amplitude)]MASK|**  
**XFER50%|XFER75%|UP|DOWN]**

set jitter generator amplitude. The (amplitude) must be in the range of 0.00-13.00 unit intervals (UIs); UP and DOWN increases or decreases the amplitude by 0.02 UIs, respectively. MASK sets the amplitude to the mask currently selected by the **JITTER:MASK** command; XFER50% and XFER75% sets the amplitude to one-half or three-fourths of the selected mask

**JITTER:GEN?**

requests the current jitter modulation, frequency, and amplitude

**JITTER:GEN:MOD?**

requests the current jitter generator modulation

**JITTER:GEN:FREQ?**

requests the current jitter generator frequency

**JITTER:GEN:AMP?**

requests the current jitter generator amplitude

Refer to Sections 3 and Appendix B for additional information about jitter generator frequencies.

Certain combinations of jitter generator, modulation, frequency, and amplitude settings are invalid. If the FIREBERD is configured for an invalid combination of settings, the execution error message **Jitter contention** appears in the error buffer, and the jitter generator keeps its last valid values. The FIREBERD 6000 can be in contention when under front panel control, but not when under remote control. If a contention exists at the time remote control is entered, some parameters are automatically selected to remove the contention condition. In this case, jitter generator modulation is turned off.

To reduce the possibility of an invalid configuration, the FIREBERD delays processing jitter generator commands until all of the commands of the program message have been read. The delayed commands are considered at the same time; an error is flagged only if this final configuration is invalid.

Refer to Appendix B for a description of all valid settings.

Example:

> <b>JITTER:GEN:AMP 3.5</b>	set the jitter generator amplitude to 3.5
> <b>JITTER:GEN:MOD OFF</b>	turn jitter generator modulation off
> <b>JITTER:GEN:AMP?</b> 03.50	requests the current jitter generator amplitude
> <b>JITTER:GEN:MOD?</b> OFF	requests the current jitter generator modulation
> <b>JITTER:GEN?</b> OFF, 10, 03.50	requests the current jitter generator modulation, frequency, and amplitude

**HITS\_THRESH**

**Jitter Hits**

**command/query**

**JITTER:HITS\_THRESH [(threshold)]UP|DOWN]** set the jitter hit threshold

**JITTER:HITS\_THRESH?** requests the current jitter hit threshold. UP or DOWN can be used to respectively raise or lower the peak jitter threshold by 0.1 UI.

When testing DS1 jitter, (threshold) is an amplitude ranging from 0.0 to 6.5 UIs, expressed as *n.n*. When testing G.703 jitter, the value of (threshold) is based on the band (i.e., BAND1 or BAND2) and the interface installed, (64 kb/s or 2048 kb/s), as follows:

<u>Interface</u>	<u>Band</u>	<u>Range</u>	<u>Increments</u>
2048 kb/s	Band 1	0.1 to 6.0 UIp	.1 UIp
	Band 2	0.05 to 0.60 UIp	.05 UIp
64 kb/s	Band 1	0.05 to 0.75 UIp	.05 UIp
	Band 2	0.05 to 0.15 UIp	.05 UIp

Example:

>**JITTER:HITS\_THRESH 0.10** set the jitter hit threshold to 0.10

>**JITTER:HITS\_THRESH?** requests the current jitter hit threshold  
0.10

**MASK**

**Jitter Masks**

**command/query**

**JITTER:MASK ["O.171"]["41451"] ["62411-1983"] ["62411-1985"] ["43801"] ["G.823"] ["G.823n"] ["D.PTT"]]** select a jitter mask. The T1 jitter masks which can be selected reflect the standards set forth in CCITT Recommendation O.171, and Bell Technical Reference Publications PUB41451, PUB43801, and PUB62411 (1983 and 1985 issues). The G.703 jitter masks which can be selected reflect the standards set forth in CCITT Recommendations O.171 and G.823, as well as DUTCH PTT standards

**JITTER:MASK?** requests the currently selected jitter mask

Example:

>**JITTER:MASK "O.171"** select the O.171 jitter mask

>**JITTER:MASK?** requests the currently selected jitter mask  
"O.171"

---

**RANGE**

---

**G.703 Jitter Measurement Range****command/query**

**JITTER:RANGE**  
**[BAND1|BAND2]** select the measurement range

**JITTER:RANGE?** requests the currently selected measurement range (BAND1 or BAND2)

The **JITTER:RANGE** command determines the range of G.703 jitter bandwidth that is measured during any given test. The range is based on the BAND selected and the interface installed, as follows:

- |                     |   |
|---------------------|---|
| 2048 kb/s Interface | <ul style="list-style-type: none"><li>• BAND1 — Up to 12.00 UI p-p.</li><li>• BAND2 — Up to 1.200 UI p-p.</li></ul> |
| 64 kb/s Interface   | <ul style="list-style-type: none"><li>• BAND1 — Up to 1.500 UI p-p.</li><li>• BAND2 — Up to 0.300 UI p-p.</li></ul> |

Example:

**>JITTER:RANGE?**  
BAND2 requests the currently selected range band

**>JITTER:RANGE BAND1** select BAND1

---

**SA**

---

**Jitter Spectrum Analyzer****command/query**

**JITTER:SA:SWEEP**  
**[OFF|ON]** set spectrum analyzer sweep. ON sweeps jitter through all 40 frequencies; OFF turns the spectrum analyzer sweep off. When using any T1 interface with jitter capability, the spectrum analyzer sweeps these frequencies:

10, 20, 30, 40, 50, 60, 70, 80,  
100, 133, 166, 200, 233, 300, 400, 500, 600, 700, 800,  
1000, 1330, 1660, 2000, 2330, 3000, 4000, 5000, 6000, 7000, 8000,  
10000, 13300, 16600, 20000, 23300, 26600, 30000, 33300, 36600, and 40000 Hz.

When using the 64 kb/s G.703 Interface, the spectrum analyzer sweeps these frequencies:

10, 20, 30, 40, 50, 60, 70, 80, 100, 133, 166, 200, 233, 300, 400, 500, 600, 700,  
800, 1000, 1330, 1660, 2000, 2330, 3000, 4000, 5000, 6000, 7000, 8000,  
10000, 13300, 16600, 20000, 23300, 26600, and 30000 Hz.

When using the 2048 kb/s G.704 Interface, the spectrum analyzer sweeps these frequencies:

10, 20, 30, 40, 50, 60, 70, 80, 100, 133, 166, 200, 233, 300, 400, 500, 600, 700, 800, 1000, 1330, 1660, 2000, 2330, 3000, 4000, 5000, 6000, 7000, 8000, 10000, 13300, 16600, 20000, 23300, 26600, 30000, 36600, 40000, 43300, 46600, 50000, 53300, 56600, 60000, 63300, 66000, 70000, 73300, 76600, 80000, 83300, 86600, 90000, 93300, 96600, and 100000 Hz.

When the jitter spectrum analyzer sweep is turned OFF, the **JITTER:SA:FREQ** command is used to select a single frequency. (frequency) is the frequency to be monitored for jitter; UP or DOWN changes the current selection to the next highest or lowest frequency based on the interface that is selected

<b>JITTER:SA:FREQ</b> <b>[(frequency)]UP DOWN]</b>	set jitter spectrum analyzer frequency
<b>JITTER:SA:LIST</b>	send a list of spectrum analyzer results to the printer buffer
<b>JITTER:SA:GRAPH</b>	graph spectrum analyzer results
<b>JITTER:SA?</b>	requests the current jitter spectrum analyzer sweep and frequency settings
<b>JITTER:SA:SWEEP?</b>	requests the current state of the jitter spectrum analyzer sweep
<b>JITTER:SA:FREQ?</b>	requests the current jitter spectrum analyzer frequency

Example:

<b>&gt;JITTER:SA:SWEEP?</b> OFF	requests the current state of the spectrum analyzer sweep
<b>&gt;JITTER:SA:SWEEP ON</b>	set the spectrum analyzer to sweep all frequencies
<b>&gt;JITTER:SA:SWEEP OFF</b>	turn the spectrum analyzer sweep off
<b>&gt;JITTER:SA:FREQ 1330</b>	monitor jitter at 1330 Hz (valid frequency for T1 interfaces)
<b>&gt;JITTER:SA?</b> OFF, 1330	requests the current spectrum analyzer sweep and frequency settings



**PRINT COMMANDS**

PRINT commands control the FIREBERD 6000 print capability. These commands can be used to obtain a hardcopy test results or a printout of the current FIREBERD configuration.

The print commands and queries are:

<b>Commands</b>	<b>Queries</b>
PRINT:CONTROLS	PRINT:CONTROLS?
PRINT:DEVICE	PRINT:DEVICE?
PRINT:EVENT	PRINT:EVENT?
	PRINT:EVENT:NORMAL?
PRINT:EVENT:NORMAL:ERROR	PRINT:EVENT:NORMAL:ERROR?
PRINT:EVENT:NORMAL:SYNC_LOSS	PRINT:EVENT:NORMAL:SYNC_LOSS?
PRINT:EVENT:NORMAL:TEST_INT	PRINT:EVENT:NORMAL:TEST_INT?
PRINT:EVENT:NORMAL:TIMED	PRINT:EVENT:NORMAL:TIMED?
PRINT:HISTOGRAM	
PRINT:HISTOGRAM:AUTO	PRINT:HISTOGRAM:AUTO?
PRINT:HISTOGRAM:FORMAT	PRINT:HISTOGRAM:FORMAT?
PRINT:HISTOGRAM:PERIOD	PRINT:HISTOGRAM:PERIOD?
PRINT:HISTOGRAM:RESULT	PRINT:HISTOGRAM:RESULT?
PRINT:HISTOGRAM:SAMPLES	PRINT:HISTOGRAM:SAMPLES?
PRINT:HISTOGRAM:VSCALE	PRINT:HISTOGRAM:VSCALE?
PRINT:MODE	PRINT:MODE?
PRINT:PRINTER	PRINT:PRINTER?
PRINT:RESULTS	PRINT:RESULTS?
PRINT:RESULTS:CUSTOM	PRINT:RESULTS:CUSTOM?
PRINT:RESULTS:TYPE	PRINT:RESULTS:TYPE?
PRINT:STATUS	PRINT:STATUS?
PRINT:TERM	PRINT:TERM?
PRINT:WIDTH	PRINT:WIDTH?

**CONTROLS**

**Controls Printouts** **command/query**

**PRINT:CONTROLS?** requests a controls printout be sent to the selected remote control port. A controls print lists the current state of all FIREBERD 6000 mainframe controls. When applicable, the state of interface controls are also listed

**PRINT:CONTROLS** sends a controls printout to the selected printer

Example:

>**PRINT:CONTROLS?** requests a controls printout be sent to the selected remote control device

.  
.  
.  
a controls print is sent to your terminal or computer

>**PRINT:CONTROLS** provides a controls printout to the printer

DEVICE

Printer Device Selection

command/query

**PRINT:DEVICE**  
**[NONE|232|488|REMOTE]**

select a printer output device. 232, 488, and REMOTE select a print device at an RS-232, IEEE-488, or remote output, respectively. NONE indicates that none of the three printer output devices are selected. Note that a printer and a remote control device cannot share the same output

**PRINT:DEVICE?**

requests the current printer output selection

Example:

>**PRINT:DEVICE?**  
 232

requests the current printer output device selection

>**PRINT:DEVICE NONE**

change the current printer output device selection to none

EVENT

Print Event Selection

command/query

**PRINT:EVENT [NORMAL|DELTA]**

select normal or delta printouts. NORMAL provides cumulative results based on one or more specific events: a time interval, an error, a synchronization loss, and a test interval. DELTA only provides those results accumulated during the most recent test interval

**PRINT:EVENT:NORMAL:ERROR (result),[OFF|ON]**

print on the occurrence of a specific error. Error events can be:

- BIT\_ERRS** :bit errors
- BLK\_ERRS** :block errors
- BPVS** :bipolar violations
- CODE\_ERR** :code error
- CRC\_ERR** :cyclic redundancy check error
- SES** :severely errored seconds
- FAS\_ERR** :frame alignment signal error
- FRA\_ERR** :frame error
- JTR\_HITS** :jitter hits
- PAT\_SLIP** :pattern slip

ON and OFF enable or disable the print error event activity.

**PRINT:EVENT:NORMAL:TIMED [OFF|(minutes)]**

print on a timed interval. The time interval is specified in minutes, and (minutes) can be any value within the range 1-1440; ON and OFF enable or disable the timed print event activity

**PRINT:EVENT:NORMAL:SYNC\_LOSS [OFF|ON]**

print on a synchronization loss. The results that are sent to the printer are those accumulated from 2 to 4 seconds preceding the synchronization loss. ON and OFF enable or disable the synchronization loss print event activity

## PRINT COMMANDS

<b>PRINT:EVENT:NORMAL: TEST_INT [OFF ON]</b>	print on a test interval. Test interval settings are controlled by the <b>CONFIG:TEST_INT</b> command. ON and OFF turn the test interval print event activity on and off, respectively
<b>PRINT:EVENT?</b>	requests the current printout selection (NORMAL or DELTA)
<b>PRINT:EVENT:NORMAL?</b>	requests all currently selected normal print events. Since the response to this query may change in size in the future, caution is advised when issuing this query
<b>PRINT:EVENT:NORMAL: ERROR? (result)</b>	requests the current print event status of any error (enabled or disabled)
<b>PRINT:EVENT:NORMAL: TIMED?</b>	requests the current timed print event setting
<b>PRINT:EVENT:NORMAL: SYNC_LOSS?</b>	requests the current synchronization loss print event setting
<b>PRINT:EVENT:NORMAL: TEST_INT?</b>	requests the current test interval print event setting

These commands and queries are dedicated to *print events*. Print events determine when the FIREBERD 6000 automatically generates a results printout.

Example:

<b>&gt;PRINT:EVENT? DELTA</b>	requests the current print event
<b>&gt;PRINT:EVENT NORMAL</b>	set the print event to normal
<b>&gt;PRINT:EVENT:NORMAL:TIMED? 60</b>	request the current timed interval generate a printout every hour
<b>&gt;PRINT:EVENT:NORMAL:TEST_INT ON</b>	enable test interval
<b>&gt;CONFIG:TEST_INT? "1.0E6"</b>	request the current test interval
<b>&gt;CONFIG:TEST_INT "1.0E4"</b>	printouts are generated at the completion of the 1.0E4 test interval
<b>&gt;PRINT:EVENT:NORMAL: ERROR? BPVS OFF</b>	requests the status of print events caused by BPVs no printouts are generated during the occurrence of BPVs
<b>&gt;PRINT:EVENT:NORMAL: ERROR BPVS,ON</b>	enable printouts during the occurrence of BPVs

## HISTOGRAM

### Histogram Setup

command/query

<b>PRINT:HISTOGRAM:AUTO [ON OFF]</b>	enable or disable results histogram printouts
--	---

<b>PRINT:HISTOGRAM:RESULT</b> <b>[1 2 3],[OFF](result)]</b>	select the result to be histogrammed and assign it a number (1 to 3)
<b>PRINT:HISTOGRAM [1 2 3]</b>	print any or all results histograms
<b>PRINT:HISTOGRAM:VSCALE</b> <b>[1 2 3],[scale)</b>	select the vertical scale for the histogram number specified. The (scale) can be any of the following:  <b>10, 20, 50, 100, 200, 500, 1K, 2K, 5K, 10K, 20K, 50K, 100K, 200K, 500K, 1M, 2M, 5M, 10M, 20M, 50M, AUTO</b>
<b>PRINT:HISTOGRAM:SAMPLES</b> <b>[5-60]</b>	select the number of samples for automatic histograms. Any number within the range 5 to 60 can be specified
<b>PRINT:HISTOGRAM:PERIOD</b> <b>[1MIN 15MIN 1HOUR 1DAY]</b>	select a sampling period
<b>PRINT:HISTOGRAM:FORMAT</b> <b>[GRAPH LIST]</b>	select a histogram format
<b>PRINT:HISTOGRAM:AUTO?</b>	requests the current status of histogram printouts (enabled or disabled)
<b>PRINT:HISTOGRAM:RESULT?</b> <b>[1 2 3]</b>	requests the current result to be histogrammed by number (1 to 3)
<b>PRINT:HISTOGRAM:</b> <b>VSCALE? [1 2 3]</b>	requests the current vertical scale for the histogram number specified (1 to 3)
<b>PRINT:HISTOGRAM:</b> <b>SAMPLES?</b>	requests the current number of samples for automatic histograms
<b>PRINT:HISTOGRAM:</b> <b>PERIOD?</b>	requests the current sampling period
<b>PRINT:HISTOGRAM:</b> <b>FORMAT?</b>	requests the current histogram format

This series of commands and queries is dedicated to histograms. Histograms offer a way to measure how a FIREBERD 6000 test result changes with time. For example, a histogram can be used to monitor bit errors that have accumulated in each hour over a 60-hour period.

The **PRINT:HISTOGRAM:RESULT** command allows the selection of up to 3 results by number (1 to 3). The (result) can be set **OFF** or to any of the following:

<b>1S_DEN_S</b>	:ones density violation seconds
<b>1SEC_CRC</b>	:one-second CRC errors
<b>ABRT_FRM</b>	:aborted frames
<b>AIS_SEC</b>	:alarm indication signal
<b>AVG_TPUT</b>	:average throughput
<b>AVL_SEC</b>	:available seconds
<b>BECN_FRM</b>	:backward explicit congestion notification frames
<b>BIT_ERRS</b>	:bit errors
<b>BIT_ERRS</b>	:bit errors
<b>BLK_ERRS</b>	:block errors
<b>BLOCKS</b>	:block errors
<b>BPV_SEC</b>	:bipolar violation seconds

## PRINT COMMANDS

BPVs	:bipolar violations
C-D_CHA	:clock-data phase changes
CHAR_ERR	:asynchronous character errors
CLK_LOSS	:clock loss
CODE_ERR	:code error
CPAR_ERR	:C-bit parity errors
CPE_S_A	:C-bit errored seconds (type A)
CPE_S_B	:C-bit errored seconds (type B)
CPE_S_C	:C-bit errored seconds (type C)
CRC_ERR	:cyclic redundancy check error
DAT_LOSS	:data loss
DE_FRM	:discard eligibility frames
DEG_MIN	:degraded minutes
EA_SEC	:errored analysis seconds
EF_EAS	:error-free error analysis seconds
ERR-SES	:bit errors minus severely errored seconds
ERR_EAS	:errored error analysis seconds
ERR_FRM	:errored frame
F_BPV_S	:far end BPV seconds
F_CRC_E	:far end CRC error events
F_F_SES	:far end severely errored framing seconds
F_FR_ES	:far end frame error seconds
F_HI_CRC	:far end high CRC error seconds
F_HS_CRC	:far end high and severe CRC error seconds
F_LO_CRC	:far end low CRC error seconds
F_MD_CRC	:far end medium CRC error seconds
F_MH_CRC	:far end medium-high CRC error seconds
F_SI_CRC	:far end single CRC error seconds
F_SLP_S	:far end controlled slip seconds
F_SV_CRC	:far end severely CRC error seconds
FAS_ERR	:frame alignment signal error
FAS_DIS_S	:frame alignment signal distant seconds
FCS_ERR	:frame check sequence errors
FEBE	:far end bit errors
FEBE_S_A	:far end bit errored seconds (Type A)
FEBE_S_B	:far end bit errored seconds (Type B)
FEBE_S_C	:far end bit errored seconds (Type C)
FEOOF_S	:far end out-of-frame seconds
FRA_ERR	:frame error
FRA_LOSS	:frame loss
FRM_CNT	:frame count
FRM_OCT	:frame octets
FRMR	:frame rejection frames
G_EFS	:G.821 error-free seconds
G_VFS	:G.821 violation-free seconds
GERR_SEC	:G.821 errored seconds
L2_ABORT	:layer 2 frame aborts
L2_F_ERR	:layer 2 frame errors
L2_FRMS	:number of layer 2 frames
LOST_FRM	:lost frames
MFAS_ERR	:multiframe alignment signal error
MF_DIS_S	:multiframe alignment signal distant seconds
NEOOF_S	:near end out-of-frame seconds
PAR_ERR	:parity errors
PAT_LOSS	:pattern synchronization loss
PAT_SLIP	:pattern slip

<b>PATL_SEC</b>	:pattern loss seconds
<b>PRM_TIM</b>	:performance report message time
<b>REBE</b>	:remote end block errors
<b>REJ_FRM</b>	:rejection frames
<b>SES</b>	:severely errored seconds
<b>SIG_LOSS</b>	:signal loss
<b>SIGL_SEC</b>	:signal loss seconds
<b>SVS</b>	:severely violated seconds
<b>T16AIS_S</b>	:Timeslot 16 alignment indication signal seconds
<b>UNA_SEC</b>	:unavailable seconds
<b>V_FR_SEC</b>	:violated frame seconds
<b>VF_EAS</b>	:violation-free error analysis seconds
<b>XS0_SEC</b>	:excess zero seconds
<b>YEL_SEC</b>	:yellow alarm seconds

**PRINT:HISTOGRAM:RESULT OFF** disables any of the histogram results listed.

The **PRINT:HISTOGRAM:FORMAT** command selects a graph or list histogram format. See Section 3 of this manual for a sample of both histogram formats. Be sure Auxiliary Function 11 is set to **REMOTE**.

Example:

```
>PRINT:HISTOGRAM:RESULT 1,BIT_ERRS      assign bit errors as histogram 1

>PRINT:HISTOGRAM:PERIOD?                 requests the current histogram period
15MIN

>PRINT:HISTOGRAM:PERIOD 1DAY             the new histogram period is 1 day

>PRINT:HISTOGRAM:VSCALE? 1              requests the current vertical scale for histogram 1
100

>PRINT:HISTOGRAM:VSCALE 1,200           the new vertical scale is 200

>PRINT:HISTOGRAM:FORMAT GRAPH           select a histogram graph

>PRINT:HISTOGRAM 1                      histogram 1 is sent to the print buffer

>STATUS:PRINT?                          requests a printout of the information in the print buffer
HISTOGRAM GRAPH
.
.
.
a bit error histogram graph is printed
```

## MODE

Select Fast or Slow Print Mode

command/query

**PRINT:MODE [FAST|SLOW]**

set the printer mode. **FAST** enables printing as fast as the FIREBERD can print; **SLOW** sets the print speed to no more than 20 characters per second with an additional one-half second delay at the end of each printed line

## PRINT COMMANDS

---

**PRINT:MODE?** requests the current print mode

Example:

>**PRINT:MODE?**  
SLOW requests the current print mode setting

>**PRINT:MODE FAST** change the print mode to fast

## PRINTER

---

**Enable/Disable Printer Output** **command/query**

**PRINT:PRINTER**  
**[ON|OFF]** enable or disable printer output. ON enables printer output; OFF disables all print functions and clears the print buffer. When OFF is selected, no printouts are generated except those that are specifically requested via the **PRINT:RESULTS** or **PRINT:CONTROLS** commands.

**PRINT:PRINTER?** requests the current state of printer output

Example:

>**PRINT:PRINTER?**  
OFF requests the current print mode setting

>**PRINT:PRINTER ON** enable printer output

## RESULTS

---

**Results Printouts** **command/query**

**PRINT:RESULTS?** send a results printout to the selected remote control device

**PRINT:RESULTS** send a controls printout to the selected printer

**PRINT:RESULTS:TYPE**  
**[STD|LONG|CUSTOM]** select a results printout format. STD prints an abbreviated list of key results; LONG prints all available results; CUSTOM customizes a printout to include any combination of test results. If desired, the results printout can be customized to include a specific set of test results. Before enabling custom printouts, use the **PRINT:RESULT:CUSTOM** command to do the actual customizing

**PRINT:RESULTS:CUSTOM**  
**[(result)|ALL],[OFF|ON]** include/exclude a specific result from a customized printout or include/exclude all results

**PRINT:RESULTS:TYPE?** requests the current results printout format

**PRINT:RESULTS:CUSTOM?**  
**[(result)|ALL]** requests the current state of any result

This series of commands and queries are dedicated to results printouts. A results print is a hardcopy of the results accumulated by the FIREBERD 6000. The remote control device and the printer is determined by auxiliary function 11 or by using the **PRINT:DEVICE** command. When the printer is set to Remote, the printout is sent to an internal remote control buffer and is not sent to a printer. The remote control buffer is accessed by sending **STATUS:PRINT?**. This causes the printout information to be sent to the remote control device.

The **PRINT:RESULTS:TYPE:CUSTOM** command is used to include or exclude a specific result from a customized printout, or include/exclude all results from the customized printout. ON includes results; OFF excludes results. After customizing the printout, use the **PRINT:RESULTS:TYPE** command to enable custom printing.

The (result) names that can be customized can be any of the following:

<b>%_MASK</b>	:percent jitter mask
<b>%ACT_SEC</b>	:percent active seconds
<b>%AVL_SEC</b>	:percent available seconds
<b>%DEG_MIN</b>	:percent degraded minutes
<b>%PAT_SEC</b>	:percent pattern sync seconds
<b>%SES</b>	:percent severely errored seconds
<b>%SVS</b>	:percent severely violated seconds
<b>%VF_EAS</b>	:percent violation free violated error analysis seconds
<b>+_LVL_dB</b>	:positive signal level (in dB)
<b>+_LVL_V</b>	:positive signal level (in volts)
<b>+_WNDR</b>	:positive wander
<b>-_LVL_dB</b>	:negative signal level (in dB)
<b>-_LVL_V</b>	:negative signal level (in volts)
<b>-_WNDR</b>	:negative wander
<b>15M_WNDR</b>	:15 minute wander
<b>1_DEN_S</b>	:ones density violation seconds
<b>1SEC_CRC</b>	:one-second CRC errors
<b>1SEC_JTR</b>	:one-second jitter
<b>24H_WNDR</b>	:24 hour wander (maximum peak-to-peak)
<b>ABRT_FRM</b>	:aborted frames
<b>AIS_SEC</b>	:alarm indication signal seconds
<b>AVG%UTIL</b>	:average percent utilization
<b>AVG_BER</b>	:average bit error rate
<b>AVG_BLER</b>	:average block error rate
<b>AVG_BPVR</b>	:average bipolar violation ratio
<b>AVG_CER</b>	:average code error rate
<b>AVG_CPER</b>	:average C-bit parity error rate
<b>AVG_CRC</b>	:average cyclic redundancy check errors
<b>AVG_FAS</b>	:average frame alignment signal error rate
<b>AVG_FEBE</b>	:average far end block error rate
<b>AVG_FER</b>	:average frame error rate
<b>AVG_FRM</b>	:average frame size
<b>AVG_MFAS</b>	:average multiframe alignment signal error rate
<b>AVG_PER</b>	:average parity error rate
<b>AVG_REBE</b>	:average remote end block error rate
<b>AVG_TPUT</b>	:average throughput
<b>AVL_SEC</b>	:available seconds
<b>BECN_FRM</b>	:backward explicit congestion notification frame
<b>BER</b>	:bit error rate
<b>BER-SES</b>	:bit error rate in non-severely errored seconds
<b>BIT_ERRS</b>	:bit errors
<b>BIT_SLIP</b>	:bit slips
<b>BLK_ERRS</b>	:block errors



## PRINT COMMANDS

<b>BLOCKS</b>	:blocks
<b>BPV_%EFS</b>	:bipolar violation percent error free seconds
<b>BPV_RATE</b>	:bipolar violation ratio
<b>BPV_SEC</b>	:bipolar violation seconds
<b>BPVs</b>	:bipolar violations
<b>CER</b>	:code error ratio
<b>C-D_CHA</b>	:clock-data phase changes
<b>CHAR_ERR</b>	:asynchronous character errors
<b>CLK_INV</b>	:clock invert
<b>CLK_LOSS</b>	:clock losses
<b>CODE_ERR</b>	:code errors
<b>CP_E_RT</b>	:C-bit parity error rate
<b>CPAR_ERR</b>	:C-bit parity errors
<b>CPE_S_A</b>	:C-bit errored seconds (Type A)
<b>CPE_S_B</b>	:C-bit errored seconds (Type B)
<b>CPE_S_C</b>	:C-bit errored seconds (Type C)
<b>CRC_E_RT</b>	:cyclic redundancy check error rate
<b>CRC_ERR</b>	:cyclic redundancy check errors
<b>DAT_INV</b>	:data invert
<b>DAT_LOSS</b>	:data loss
<b>DAT_RATE</b>	:data rate
<b>DATA_STATUS</b>	:ISDN data call status
<b>DATA_TEI</b>	:data terminal endpoint identifier
<b>DE_FRM</b>	:discard eligibility frame
<b>DEG_MIN</b>	:degraded minutes
<b>DELAY</b>	:delay
<b>EA_SEC</b>	:error analysis seconds
<b>EF_EAS</b>	:error-free error analysis seconds
<b>ELAP_SEC</b>	:elapsed seconds
<b>ERR-SES</b>	:bit errors in non-severely errored seconds
<b>ERR_EAS</b>	:errored error analysis seconds
<b>ERR_FRM</b>	:errored frame
<b>F_BPV_S</b>	:far end BPV seconds
<b>F_CRC_E</b>	:far end CRC error events
<b>F_F_SES</b>	:far end severely errored framing seconds
<b>F_FR_ES</b>	:far end frame error seconds
<b>F_HI_CRC</b>	:far end high CRC error seconds
<b>F_HS_CRC</b>	:far end high and severe CRC error seconds
<b>F_LO_CRC</b>	:far end low CRC error seconds
<b>F_MD_CRC</b>	:far end medium CRC error seconds
<b>F_MH_CRC</b>	:far end medium-high CRC error seconds
<b>F_SI_CRC</b>	:far end single CRC error seconds
<b>F_SLP_S</b>	:far end controlled slip seconds
<b>F_SV_CRC</b>	:far end severely CRC error seconds
<b>FAS_E_RT</b>	:frame alignment signal error rate
<b>FAS_ERR</b>	:frame alignment signal errors
<b>FASDIS_S</b>	:frame alignment signal distant seconds
<b>FCS_ERR</b>	:frame check sequence errors
<b>FE_RATE</b>	:frame error rate
<b>FEBE</b>	:far end block errors
<b>FEBE_RT</b>	:far end block error rate
<b>FEBE_S_A</b>	:far end bit errored seconds (Type A)
<b>FEBE_S_B</b>	:far end bit errored seconds (Type B)
<b>FEBE_S_C</b>	:far end bit errored seconds (Type C)
<b>FEOF_S</b>	:far end out-of-frame seconds
<b>FECN_FRM</b>	:forward explicit congestion notification frame

<b>FRA_ERR</b>	:frame errors
<b>FRA_LOSS</b>	:frame losses
<b>FRM_CNT</b>	:frame count
<b>FRM_OCTS</b>	:frame octets
<b>FRMR</b>	:frame reject frames
<b>G%EFS</b>	:G.821 percent error-free seconds
<b>G%VFS</b>	:G.821 percent violation-free seconds
<b>G_EFS</b>	:G.821 error-free seconds
<b>G_VFS</b>	:G.821 violation-free seconds
<b>GEN_FREQ</b>	:generator frequency
<b>GERR_SEC</b>	:G.821 errored seconds
<b>INTERFACE</b>	:interface label
<b>JTR_FREQS</b>	:jitter print header
<b>JTR_HITS</b>	:jitter hits
<b>L2_ABORT</b>	:layer 2 aborts
<b>L2_F_ERR</b>	:layer 2 frame errors
<b>L2_FRMS</b>	:number of layer 2 frames
<b>LMI_ERRS</b>	:local management interface errors
<b>LMI_TMOS</b>	:local management interface timeouts
<b>LOST_FRM</b>	:lost frames
<b>LVL_DBM</b>	:signal level (in dBm)
<b>MAX%UTIL</b>	:maximum percent utilization
<b>MAX_JTR</b>	:maximum jitter
<b>MAX_TPUT</b>	:maximum throughput
<b>MAX_ZERO</b>	:maximum zeros
<b>MFAS_ERR</b>	:multiframe alignment signal word errors
<b>MF_DIS_S</b>	:multiframe alignment signal distant seconds
<b>MFS_E_RT</b>	:multiframe alignment signal error rate
<b>NEOF_S</b>	:near end out-of-frame seconds
<b>PAR_E_RT</b>	:parity error rate
<b>PAR_ERR</b>	:parity errors
<b>PAT_LOSS</b>	:pattern sync losses
<b>PAT_SLIP</b>	:pattern slips
<b>PATL_SEC</b>	:pattern sync loss seconds
<b>PAY_SRC</b>	:payload source and loopback status
<b>PP_WNDR</b>	:peak-to-peak wander
<b>PP_LVL_V</b>	:peak-to-peak level (in volts)
<b>PRM_TIM</b>	:performance report message time
<b>PVC_STAT</b>	:permanent virtual circuit status
<b>PWR_LOSS</b>	:power losses
<b>PWR_STAT</b>	:ISDN power feeding status
<b>R_LVL_DB</b>	:receive level (in dB)
<b>R_LVL_V</b>	:receive level (in volts)
<b>RCV_BOM</b>	:receive bit oriented message
<b>RCV_BYTE</b>	:received byte
<b>RCV_CODE</b>	:received code
<b>RCV_FAS</b>	:received frame alignment signal word
<b>RCV_FEAC</b>	:received FEAC code
<b>RCV_FREQ</b>	:receive frequency
<b>RCV_MFAS</b>	:received multiframe alignment signal word
<b>RCV_NFAS</b>	:received not frame alignment signal word
<b>REBE</b>	:remote end block errors
<b>REBE_RT</b>	:remote end block error rate
<b>REJ_FRM</b>	:reject frames
<b>RT_DELAY</b>	:round trip delay
<b>RX_ABCD</b>	:received ABCD (signaling bits)

## PRINT COMMANDS

<b>RX_INFO</b>	:receiver INFO state
<b>RX_X1_X2</b>	:received X bits
<b>SELF_LOOP</b>	:self loop
<b>SES</b>	:severely errored seconds
<b>SHRT_FRM</b>	:short frames
<b>SIG_LOSS</b>	:signal losses
<b>SIGL_SEC</b>	:signal loss seconds
<b>SIGNALING</b>	:signaling LEDs
<b>SITE_ID</b>	:site identification
<b>SMPX_CUR</b>	:simplex current
<b>SVS</b>	:severely violated seconds
<b>T16AIS_S</b>	:timeslot 16 alignment indication signal seconds
<b>TEI</b>	:terminal endpoint identifier
<b>TIME_DATE</b>	:time and date
<b>TOT_OCTS</b>	:total octets
<b>TX_INFO</b>	:transmitter INFO state
<b>UNA_SEC</b>	:unavailable seconds
<b>V_FR_SEC</b>	:violated frame seconds
<b>VCE_TEI</b>	:voice terminal endpoint identifier
<b>VF_EAS</b>	:violation-free error analysis seconds
<b>VOICE_STATUS</b>	:ISDN voice call status
<b>XS0_SEC</b>	:excess zero seconds
<b>YEL_SEC</b>	:yellow alarm seconds

Example:

<b>&gt;PRINT:RESULTS_TYPE LONG</b>	select long results printout
<b>&gt;PRINT:RESULTS?</b>	requests the long results printout be generated
.	
.	
.	a long results print is sent to the selected print device
<b>&gt;PRINT:RESULTS</b>	generates a long results printout

## STATUS

### Status Printouts

command/query

**PRINT:STATUS (type),[OFF|ON]** include/exclude a specific status print that cause a printout to be generated. Enabling the status event (turning it ON) allows a printout to be generated when the enabled event occurs. The (type) can be any of the following:

<b>ASYNCH_FRAME_ERROR</b>	:asynchronous frame error
<b>CLOCK_LOSS</b>	:clock loss
<b>DATA_LOSS</b>	:data loss
<b>FRAME_SYNC_LOSS</b>	:frame sync loss
<b>G821_TRANSITION</b>	:G.821 transition
<b>INTERFACE</b>	:interface

<b>RCVR_CLK_POL_CHNG</b>	:receiver clock polarity change
<b>POWER_UP</b>	:power up
<b>SIGNALING_CHANGE</b>	:frame sync loss
<b>SIGNAL_LOSS</b>	:signal loss
<b>SYNC_ACQUIRED</b>	:sync acquired
<b>SYNC_LOSS</b>	:sync loss
<b>TEST_RESTART</b>	:test restart

**PRINT:STATUS? (type)** requests the current state of status printouts

Note that status printouts are only generated when the **PRINT:PRINTER** command is ON (i.e., the FIREBERD 6000 print capability is enabled).

Example:

**>PRINT:STATUS? SYNC\_LOSS** requests the current state of status printouts when synchronization is lost  
ON

**>PRINT:STATUS? DATA LOSS, OFF** disable status prints when data is lost

**TERM**

**Line Terminator** **command/query**

**PRINT:TERM**  
**[CR|LF|CRLF]** set the line terminator sequence that is transmitted at the end of each printed line. Valid line terminators are carriage return (CR), linefeed (LF), and carriage return/linefeed pair (CRLF)

**PRINT:TERM?** requests the currently selected line terminator

Example:

**>PRINT:TERM LF** set the line terminator to line feed

**>PRINT:TERM?** requests the current line terminator  
LF

**WIDTH**

**Printout Width** **command/query**

**PRINT:WIDTH**  
**[20|40|80]** set the number of characters per line; 20, 40, or 80 columns can be specified. Note that the width should be set in accordance with the size of the printer or CRT being used

## PRINT COMMANDS

---

**PRINT:WIDTH?** requests the current printer width

Example:

**>PRINT:WIDTH 40** set width to 40 columns

**>PRINT:WIDTH?** requests the current line width

40

**REMOTE CONTROL COMMANDS**

REMOTE CONTROL commands are used to set FIREBERD 6000 functions that are not grouped with other commands.

The REMOTE CONTROL commands and queries are:

Commands	Queries
LOCAL	
LOCKOUT	LOCKED?
RC_MODE	RC_MODE?
UNLOCK	

**LOCAL**

**Local Mode** **command**

**LOCAL** returns the FIREBERD 6000 to local mode and makes the front-panel switches active. The FIREBERD remains in local mode until it receives a valid remote control command or query from the controller

This command is not valid when using the IEEE-488 interface. When the IEEE-488 Interface is used, the Go-To-Local (GTL) bus-level command performs a similar function. See your controller documentation.

Example:

>**LOCAL** enter local (front panel) mode

**LOCKOUT**

**Front-Panel Lockout (RS-232 Only)** **command**

**LOCKOUT** lock out the front panel

**UNLOCK** enables the **ENTER** key on the FIREBERD 6000 MENU keypad. When pressed, the **ENTER** key returns the FIREBERD to front-panel control. This command does not directly enable all front-panel controls

**LOCKED?** requests whether the front panel is locked out. Displays the current status of this command. ON indicates the front panel is completely disabled; OFF indicates that the **ENTER** key can be pressed to restore front-panel operation

The **LOCKOUT** command disables all FIREBERD 6000 front-panel control so that it is not possible to affect a test from the front panel.

See the **LOCAL** command.

## REMOTE CONTROL COMMANDS

These commands are not valid when using the IEEE-488 Interface. When the IEEE-488 Interface is used, the bus-level local-lockout (LLO) command performs a similar function. See your controller documentation.

Example:

- >**LOCKOUT**                           the front panel is disabled
- >**LOCKED?**                           check the locked state  
ON
- >**UNLOCK**                           press the **ENTER** key on the front panel to restore front-panel operation

### RC\_MODE

---

**Remote Control Mode** **command/query**

**RC\_MODE [TERMINAL|  
COMPUTER]**                           place the FIREBERD in terminal or computer mode

**RC\_MODE?**                           requests the current remote control mode

When using the RS-232 Remote Control Interface, the **RC\_MODE** command places the FIREBERD 6000 in either terminal or computer remote control mode. Computer mode is specified when using a programmed controller; terminal mode is specified when using a dumb terminal.

Example:

- >**RC\_MODE?**                           requests the remote control mode  
TERMINAL
- >**RC\_MODE COMPUTER**               place the FIREBERD 6000 in computer mode

**NOTE:** When using the RS-232 Printer/Controller Interface, a CTRL-C (Control C) places the FIREBERD 6000 in the terminal mode, just as the **RC\_MODE TERMINAL** command does.

**RESULT COMMANDS**

The RESULT commands and queries are used to retrieve test results. In addition to the basic ability to query individual measurements, it is also possible to capture all of the results that are available in a single test.

The RESULTS commands and queries are:

Commands	Queries
RESULT:CLEAR	
RESULT:DISPLAY:HOLD	RESULT?
RESULT:DISPLAY	RESULT:DISPLAY:HOLD?
	RESULT:DISPLAY?
	RESULT:HELD?
RESULT:DISPLAY:PRE_SYNCLOSS	
RESULT:HOLD	
RESULT:PRE_SYNCLOSS	
RESULT:RESTART	

**CLEAR**

---

**Clear Result** **command**

**RESULT:CLEAR**                      clears all test result values without forcing the receiver to resynchronize. This command does not cause a test restart

Example:

>**RESULT:CLEAR**                      clear all test result values

**DISPLAY**

---

**Control Results Display** **command/query**

**RESULT:DISPLAY [1|2],**                      show the specified (result\_name) in the left or right results display (1 or 2, respectively)  
**(result\_name)**

**RESULT:DISPLAY? [1|2]**                      return the name of the result in the left or right results display

The following list contains all valid result names and the category in which they occur.

Category	Result Command	Result Description
ERROR	ABRT_FRM	Aborted Frames
	AVG_BER	Average Bit Error Rate
	AVG_BLER	Average Block Error Rate
	AVG_FRM	Average Frame Size
	BECN_FRM	Backward Explicit Congestion Notification Frame
	BER	Bit Error Rate
	BIT_ERRS	Bit Errors
	BLK_ERRS	Block Errors



## RESULT COMMANDS

Category	Result Command	Result Description
	BLOCKS	Blocks
	CHAR_ERR	Asynchronous Character Errors
	DE_FRM	Discard Eligibility Frame
	ERR_FRM	Errored Frame
	FECN_FRM	Forward Explicit Congestion Notification Frame
	FRM_CNT	Frame Count
	FRM_OCTS	Frame Octets
	LMI_ERRS	Local Management Interface Errors
	LMI_TMOS	Local Management Interface Timeouts
	LOST_FRM	Lost Frames
	PAT_SLIP	Pattern Slips
	PVC_STAT	Permanent Virtual Circuit Status
	SHRT_FRM	Short Frames
	TOT_OCTS	Total Octets
PERFORMANCE	%AVL_SEC	Percent Available Seconds
	%DEG_MIN	Percent Degraded Minutes
	%SES	Percent Severely Errored Seconds
	%SVS	Percent Severely Violated Seconds
	AVG%UTIL	Average Percent Utilization
	AVG_TPUT	Average Throughput
	AVL_SEC	Available Seconds
	BER-SES	Bit Error Rate Over non-Severely Errored Seconds
	DEG_MIN	Degraded Minutes
	ERR-SES	Bit Errors Over non-Severely Errored Seconds
	G_%EFS	G.821 Percent Error Free Seconds
	G_%VFS	G.821 Percent Violation Free Seconds
	G_EFS	G.821 Error Free Seconds
	G_VFS	G.821 Violation Free Seconds
	GERR_SEC	G.821 Errored Seconds
	MAX_TPUT	Maximum Throughput
	MAX%UTIL	Maximum Percent Utilization
	SES	Severely Errored Seconds
	SVS	Severely Violated Seconds
	UNA_SEC	Unavailable Seconds
TIME	%ACT_SEC	Percent Active Seconds
	%PAT_SEC	Percent Synchronized Seconds
	BPV_%EFS	Bipolar Violation Percent Error Free Seconds
	BPV_SEC	Bipolar Violation Seconds
	CPE_S_A	C-bit Parity Errored Seconds (Type A)
	CPE_S_B	C-bit Parity Errored Seconds (Type B)
	CPE_S_C	C-bit Parity Errored Seconds (Type C)
	DATE	Date
	EA_SEC	Error Analysis Seconds
	EF_EAS	Error Free Error Analysis Seconds
	ELAP_SEC	Elapsed Seconds
	ERR_EAS	Errored Error Analysis Seconds
	FEBE_S_A	Far End Block Errored Seconds (Type A)
	FEBE_S_B	Far End Block Errored Seconds (Type B)
	FEBE_S_C	Far End Block Errored Seconds (Type C)
	PATL_SEC	Pattern Sync Loss Seconds
	SIGL_SEC	Signal Loss Seconds
	TIME	Time

Category	Result Command	Result Description
SIGNAL	%_MASK	Maximum Percent of Jitter Mask
	+_LVL_DB	Positive Level in Decibels
	+_LVL_V	Positive Level in Volts
	+_WNDR	Positive Peak-to-Peak Wander
	-_LVL_DB	Negative Level in Decibels
	-_LVL_V	Negative Level in Volts
	-_WNDR	Negative Peak-to-Peak Wander
	1SEC_JTR	One-Second Jitter
	15M_WNDR	15-Minute Wander
	24H_WNDR	24-Hour Wander
SIGNAL	DAT_RATE	Data Rate
	GEN_FREQ	Generator Clock Frequency
	JTR_HITS	Jitter Hits
	LVL_DBM	Power Level of All-Ones Signal in dBm
	MAX_JTR	Maximum Jitter
	PP_LVL_V	Peak-to-Peak Level in Volts
	PP_WNDR	Peak-to-Peak Wander
	PWR_STAT	ISDN Power Feeding Status
	R_LVL_DB	Receiver Signal Level in Decibels
	R_LVL_V	Receiver Signal Level in Volts
	RCV_BYTE	Receive Byte
	RCV_CODE	Receive Code
	RCV_FREQ	Receiver Clock Frequency
	RT_DELAY	Round Trip Delay
	RX_INFO	Receiver Information Sequence State
	SA_FREQ	Spectrum Analyzer Frequency
	SMPX_CUR	Simplex Current
	TEI	Terminal Endpoint Identifier Assigned
	TX_INFO	Transmitter Information Sequence State
	VOICE_TEI	Voice Terminal Endpoint Identifier
T-CARRIER	%VF_EAS	Percent Violation Free Error Analysis Seconds
	1SEC_CRC	One-Second CRC Errors
	AVG_BPVR	Average Bipolar Violation Rate
	AVG_CER	Average Code Error Ratio
	AVG_CPER	Average C-bit Parity Error Rate
	AVG_CRC	Average CRC Errors
	AVG_FAS	Average Frame Alignment Signal Error Rate
	AVG_FEBE	Average Far End Block Error Rate
	AVG_FER	Average Frame Error Rate
	AVG_MFAS	Average Multiframe Alignment Signal Error Rate
	AVG_PER	Average Parity Error Rate
	AVG_REBE	Average Remote End Block Errors
	BIT_SLIP	Bit Slips
	BPV_RATE	Bipolar Violation Rate
	BPVS	Bipolar Violations
	CER	Code Error Rate
	CODE_ERR	Code Errors

## RESULT COMMANDS

Category	Result Command	Result Description
T-CARRIER	CP_E_RT	C-bit Parity Error Rate
	CPAR_ERR	C-bit Parity Errors
	CRC_E_RT	CRC Error Rate
	CRC_ERR	CRC Errors
	F_BPV_S	Far End BPV Seconds
	F_CRC_E	Far End CRC Error Events
	F_F_SES	Far End Severely Errored Framing Seconds
	F_FR_ES	Far End Frame Error Seconds
	F_HI_CRC	Far End High CRC Error Seconds
	F_HS_CRC	Far End High and Severe CRC Error Seconds
	F_LO_CRC	Far End Low CRC Error Seconds
	F_MD_CRC	Far End Medium CRC Error Seconds
	F_MH_CRC	Far End Medium-High CRC Error Seconds
	F_SI_CRC	Far End Single CRC Error Seconds
	F_SLP_S	Far End Controlled Slip Seconds
	F_SV_CRC	Far End Severely Errored CRC Seconds
	FAS_E_RT	Frame Alignment Signal Error Rate
	FAS_ERR	Frame Alignment Signal Errors
	FCS_ERR	Frame Check Sequence Errors
	FE_RATE	Frame Error Rate
	FEBE	Far End Block Errors
	FEBE_RT	Far End Block Error Rate
	FRA_ERR	Frame Errors
	FRA_LOSS	Frame Synchronization Loss Count
	FRMR	Frame Reject Frames
	L2_ABORT	Layer 2 Aborts
	L2_F_ERR	Layer 2 Frame Errors
	L2_FRMS	Number of Layer 2 Frames
	MAX_ZERO	Maximum Consecutive Zeros
	MFAS_ERR	Multiframe Alignment Signal Word Errors
	MFS_E_RT	Multiframe Alignment Signal Error Rate
	PAR_E_RT	Parity Error Rate
	PAR_ERR	Parity Errors
	PAY_SRC	Payload Source and Loopback Status
	PRM_TIM	Performance Report Message Time
	RCV_BOM	Received Bit-Oriented Message
	RCV_FAS	Received Frame Alignment Signal Word
	RCV_FEAC	Received FEAC Code
	RCV_MFAS	Received Multiframe Alignment Signal Word
	RCV_NFAS	Received Not Frame Alignment Signal Word
	REBE	Remote End Block Errors
	REBE_RT	Remote End Block Error Rate
REJ_FRM	Reject Frames	
RX_ABCD	DS0 ABCD Signal	
RX_X1_X2	Received X Bits	
VF_EAS	Violation free Error Analysis Seconds	

Category	Result Command	Result Description
ALARM	IS_DEN_S	Ones Density Violation Seconds
	C-D_CHA	Clock-Data Phase Change
	PWR_LOSS	Power Loss
	V_FRA_SEC	Violated Frame Seconds
	PAT_LOSS	Pattern Sync Loss Count
	DAT_LOSS	Receiver Data Loss Count
	CLK_LOSS	Receiver Clock Loss Count
	SIG_LOSS	Receiver Signal Loss Count
	YEL_SEC	Yellow Alarm Seconds
	FASDIS_S	Frame Alignment Signal Distant Alarm Seconds
	XS0_SEC	Excess Zeros Seconds
	AIS_SEC	Alarm Indication Signal Seconds
	T16AIS_S	Timeslot 16 Alarm Indication Signal Seconds
	MF_DIS_S	Multiframe Alignment Signal Distant Alarm Seconds
	FEOOF_S	Far End Out-of-Frame Seconds
	NEOOF_S	Near End Out-of-Frame Seconds

Example:

>**RESULT:DISPLAY? 1**  
BIT\_ERRS return the result in the left results display

>**RESULT:DISPLAY 1,BER** display the current BER in the left results display

## DISPLAY:HOLD

**Control Display Hold** command/query

**RESULT:DISPLAY:HOLD** turn display hold ON or OFF. ON enables display hold; OFF turns display hold off

[ON|OFF]

**RESULT:DISPLAY:HOLD?** return the current state of the display hold activity

This command is identical in function to the **DISPLAY HOLD** switch, located on the FIREBERD front panel.

Example:

>**RESULT:DISPLAY:HOLD?**  
OFF requests the current setting

>**RESULT:DISPLAY:HOLD ON** enable display hold

**DISPLAY:PRE\_SYNCLOSS**

---

**View Pre-Sync Loss Results at Front Panel****command****RESULT:DISPLAY:  
PRE\_SYNCLOSS** display pre-sync loss test results on the FIREBERD front panel

This remote control command automatically initiates a **RESULT:DISPLAY:HOLD** command so that these results can be examined over an extended period of time.

Example:

**>RESULT:DISPLAY:PRE\_SYNCLOSS** recall pre-sync loss results; a pre-sync loss results listing is displayed**>RESULT:DISPLAY:HOLD OFF** release the automatically generated display hold**HELD**

---

**Read Held Results****query****RESULT:HELD?  
(result\_name)** read the results that are held in the remote control RESULTS HOLD buffer

The storing of test results is invoked by the **RESULT:HOLD** command.

Example:

**>RESULT:HOLD** store all test results in the RESULTS HOLD buffer**>RESULT:HELD? BIT\_ERRS  
1** read the number of bit errors that were counted when the **RESULT:HOLD** command was specified**>RESULT? BIT\_ERRS  
2** show the current bit error count**HOLD**

---

**Result Hold****command****RESULT:HOLD  
[ON|OFF]** hold or release current test results in the RESULTS HOLD buffer

This allows the user to read test results without their values changing. (See also: **RESULT:HELD**.)

Example:

**>RESULT:HOLD** store all test results in the remote control RESULTS HOLD buffer

**PRE\_SYNCLOSS****Pre-Sync Loss Results at Remote Controller****command****RESULT:PRE\_SYNCLOSS** display pre-sync loss test results at the remote controller

The **RESULT:PRE\_SYNCLOSS** command enables pre-sync loss test results to be displayed at the remote control RESULTS HOLD buffer. This remote control command automatically initiates a **RESULT:HOLD** command so that these results may be examined for an extended period of time.

Example:

>**RESULT:PRE\_SYNCLOSS** recall pre-sync loss results  
a pre-sync loss results listing is displayed in the remote control RESULTS HOLD buffer

>**RESULT:HOLD OFF** release the display hold which is automatically generated by the **RESULT:PRE\_SYNCLOSS** command

**RESTART****Test Restart****command****RESULT:RESTART** restart a test

The **RESULT:RESTART** command clears all test results and alarms, forces the receiver to resynchronize to the incoming data pattern, and starts a new test.

Example:

>**RESULT:RESTART** restart a test

**RESULT****Result Value****query**

**RESULT? (result\_name)** return the current value of the specified result

## RESULT COMMANDS

The **RESULT** query returns the current value of the specified (result\_name). If the result is not applicable in the current test mode, no response is generated. If the result is applicable but “not ready,” a special value is returned, as follows:

Result	Not-Ready Value	Definition
%_MASK	“NOT READY”	Maximum Percent of Jitter Mask
%ACT_SEC	“NOT READY”	Percent Active Seconds
%AVL_SEC	“NOT READY”	Percent Available Seconds
%DEG_MIN	“NOT READY”	Percent Degraded Minutes
%PAT_SEC	“NOT READY”	Percent Synchronized Seconds
%SES	“NOT READY”	Percent Severely Errored Seconds
%SVS	“NOT READY”	Percent Severely Violated Seconds
%VF_EAS	“NOT READY”	Percent Violation Free Error Analysis Seconds
+_LVL_DB	“NOT READY”	Positive Level in dB
+_LVL_V	“NOT READY”	Positive Level in Volts
+_WNDR	“NOT READY”	Positive Peak-to-Peak Wander
-_LVL_DB	“NOT READY”	Negative Level in dB
-_LVL_V	“NOT READY”	Negative Level in Volts
-_WNDR	“NOT READY”	Negative Peak-to-Peak Wander
15M_WNDR	“NOT READY”	15-Minute Wander
1S_DEN_S	-1	Ones Density Violation Seconds
1SEC_CRC	-1	One Second CRC Errors
1SEC_JTR	“NOT READY”	One Second Jitter
24H_WNDR	“NOT READY”	24-Hour Wander
ABRT_FRM	“NOT READY”	Aborted Frames
AIS_SEC	-1	Alarm Indication Signal Seconds
AVG_BER	-1.0E+0	Average Bit Error Rate
AVG_BLER	-1.0E+0	Average Block Error Rate
AVG_BPVR	-1.0E+0	Average Bipolar Violation Rate
AVG_CER	-1.0E+0	Average Code Error Ratio
AVG_CPER	-1.0E+0	Average C-bit parity Error Rate
AVG_CRC	-1.0E+0	Average CRC Errors
AVG_FAS	-1.0E+0	Average Frame Alignment Signal Error Rate
AVG_FEBE	-1.0E+0	Average Far End Block Error Rate
AVG_FER	-1.0E+0	Average Frame Error Rate
AVG_FRM	“NOT READY”	Average Frame Size
AVG_MFAS	-1.0E+0	Average Multiframe Alignment Signal Error Rate
AVG_PER	-1.0E+0	Average Parity Error Rate
AVG_REBE	-1.0E+0	Average Remote End Block Errors
AVG_TPUT	“NOT READY”	Average Throughput
AVG%UTIL	“NOT READY”	Average Percent Utilization
AVL_SEC	-1	Available Seconds
BECN_FRM	“NOT READY”	Backward Explicit Congestion Notification Frame
BER	-1.0E+0	Bit Error Rate
BER-SES	-1.0E+0	Bit Error Rate Over non-Severely Errored Seconds
BIT_ERRS	-1	Bit Errors
BIT_SLIP	-1	Bit Slips
BLK_ERRS	-1	Block Errors
BLOCKS	-1	Blocks
BPV_%EFS	-1.0E+0	Bipolar Violation Percent Error Free Seconds
BPV_RATE	-1.0E+0	Bipolar Violation Rate
BPV_SEC	-1	Bipolar Violation Seconds
BPVS	-1	Bipolar Violations
C-D_CHA	-1	Clock-Data Phase Changes
CER	-1.0E+0	Code Error Rate

Result	Not-Ready Value	Definition
CHAR_ERR	-1	Asynchronous Character Errors
CLK_INV	"NOT READY"	Clock Inversion
CLK_LOSS	-1	Clock Losses
CODE_ERR	-1	Code Errors
CP_E_RT	-1.0E+0	C-bit Parity Error Rate
CPAR_ERR	-1	C-bit Parity Errors
CPE_S_A	-1	C-bit Parity Errored Seconds (Type A)
CPE_S_B	-1	C-bit Parity Errored Seconds (Type B)
CPE_S_C	-1	C-bit Parity Errored Seconds (Type C)
CRC_E_RT	-1.0E+0	CRC Error Rate
CRC_ERR	-1	CRC Errors
DAT_INV	"NOT READY"	Data Inversion
DAT_LOSS	-1	Receiver Data Loss Count
DAT_RATE	-1.00	Data Rate
DATA_STATUS	"NOT READY"	ISDN Data Call Status
DATA_TEI	"NOT READY"	Data Terminal Endpoint Identifier
DATE	"NOT READY"	Date
DE_FRM	"NOT READY"	Discard Eligibility Frame
DEG_MIN	-1	Degraded Minutes
DELAY	"NOT READY"	Delay
EA_SEC	-1	Error Analysis Seconds
EF_EAS	-1	Error Free Error Analysis Seconds
ELAP_SEC	-1	Elapsed Seconds
ERR_SES	-1	Bit Errors Over Non-Severely Errored Seconds
ERR_EAS	-1	Errored Error Analysis Seconds
ERR_FRM	"NOT READY"	Errored Frame
F_BPV_S	-1	Far End BPV Seconds
F_CRC_E	-1	Far End CRC Error Events
F_F_SES	-1	Far End Severely Errored Framing Seconds
F_FR_ES	-1	Far End Frame Error Seconds
F_HI_CRC	-1	Far End High CRC Error Seconds
F_HS_CRC	-1	Far End High and Severe CRC Error Seconds
F_LO_CRC	-1	Far End Low CRC Error Seconds
F_M_CRC	-1	Far End Medium CRC Error Seconds
F_MH_CRC	-1	Far End Medium-High CRC Error Seconds
F_SI_CRC	-1	Far End Single CRC Error Seconds
F_SLP_S	-1	Far End Controlled Slip Seconds
F_SV_CRC	-1	Far End Severely Errored CRC Seconds
FAS_E_RT	-1.0E+0	Frame Alignment Signal Error Rate
FAS_ERR	-1	Frame Alignment Signal Errors
FASDIS_S	-1	Frame Alignment Signal Distant Alarm Seconds
FCS_ERR	-1	Frame Check Sequence Errors
FE_RATE	-1.0E+0	Frame Error Rate
FEBE	-1	Far End Block Errors
FEBE_RT	-1.0E+0	Far End Block Error Rate
FEBE_S_A	-1	Far End Block Errored Seconds (Type A)
FEBE_S_B	-1	Far End Block Errored Seconds (Type B)
FEBE_S_C	-1	Far End Block Errored Seconds (Type C)
FECN_FRM	"NOT READY"	Forward Explicit Congestion Notification Frame
FEOOF_S	-1	Far End Out-of-Frame Seconds
FRA_ERR	-1	Frame Errors
FRA_LOSS	-1	Frame Synchronization Loss Count
FRM_CNT	"NOT READY"	Frame Count



## RESULT COMMANDS

Result	Not-Ready Value	Definition
FRM_OCTS	"NOT READY"	Frame Octets
FRMR	-1	Frame Reject Frames
G_%EFS	"NOT READY"	G.821 Percent Error Free Seconds
G_%VFS	"NOT READY"	G.821 Percent Violation Free Seconds
G_EFS	-1	G.821 Error Free Seconds
G_VFS	-1	G.821 Violation Free Seconds
GEN_FREQ	"NOT READY"	Generator Clock frequency
GERR_SEC	-1	G.821 Errored Seconds
INTERFACE	"NOT READY"	Interface Label
JTR_FREQS	"NOT READY"	Jitter Print Header
JTR_HITS	-1	Jitter Hits
L2_ABORT	-1	Layer 2 Aborts
L2_F_ERR	-1	Layer 2 Frame Errors
L2_FRMS	-1	Number of Layer 2 Frames
LMI_ERRS	"NOT READY"	Local Management Interface Errors
LMI_TMOS	"NOT READY"	Local Management Interface Timeouts
LOST_FRM	"NOT READY"	Lost Frames
LVL_DBM	"NOT READY"	Power Level of All-Ones Signal in dBm
MAX_JTR	"NOT READY"	Maximum Jitter
MAX_TPUT	"NOT READY"	Maximum Throughput
MAX_ZERO	-1	Maximum Consecutive Zeros
MAX%UTIL	"NOT READY"	Maximum Percent Utilization
MF_DIS_S	-1	Multiframe Alignment Signal Distant Alarm Seconds
MFAS_ERR	-1	Multiframe Alignment Signal Word Errors
MFS_E_RT	-1.0E+0	Multiframe Alignment Signal Word Error Rate
NEOF_S	-1	Near End Out-of-Frame Seconds
PAR_E_RT	-1.0E+0	Parity Error Rate
PAR_ERR	-1	Parity Errors
PAT_LOSS	-1	Pattern Sync Loss Count
PAT_SLIP	-1	Pattern Slips
PATL_SEC	-1	Pattern Sync Loss Seconds
PAY_SRC	"NOT READY"	Payload Source and Loopback Status
PVC_STAT	-1	Permanent Virtual Circuit Status
PRM_TIM	-1	Performance Report Message Time
PP_LVL_V	"NOT READY"	Peak-to-Peak Level in Volts
PP_WNDR	"NOT READY"	Peak-to-Peak Wander
PWR_LOSS	-1	Power Loss
PRW_STAT	"NOT READY"	ISDN Power Feeding Status
R_LVL_DB	-1.00	Receiver Signal Level in Decibels
R_LVL_V	-1.00	Receiver Signal Level in Volts
RCV_BOM	"NOT READY"	Received Bit-Oriented Message
RCV_BYTE	"NOT READY"	Receive Byte
RCV_CODE	"NOT READY"	Receive Code
RCV_FAS	"NOT READY"	Received Frame Alignment Signal Word
RCV_FEAC	"NOT READY"	Received FEAC Code
RCV_MFAS	"NOT READY"	Received Multiframe Alignment Signal Word
RCV_NFAS	"NOT READY"	Received Not Frame Alignment Signal Word
REBE	-1	Remote End Block Errors
REBE_RT	-1.0E+0	Remote End Block Error Rate
REJ_FRM	-1	Reject Frames
RT_DELAY	"NOT READY"	Round Trip Delay
RX_ABCD	"NOT READY"	DS0 ABCD Signal
RX_INFO	"NOT READY"	Receiver Information Sequence State

Result	Not-Ready Value	Definition
RX_X1_X2	"NOT READY"	Received X bits
S_A	"NOT READY"	Spectrum Analyzer Frequency
SELF_LOOP	"NOT READY"	Self Loop
SES	-1	Severely Errored Seconds
SHRT_FRM	"NOT READY"	Short Frames
SIG_LOSS	-1	Receiver Signal Loss Count
SIGL_SEC	-1	Signal Loss Seconds
SIGNALING	"NOT READY"	Signaling LEDs
SITE_ID	"NOT READY"	Site Identification
SMPX_CUR	"NOT READY"	Simplex Current
SVS	-1	Severely Violated Seconds
T16AIS_S	-1	Timeslot 16 Alarm Indication Seconds
TEI	"NOT READY"	Terminal Endpoint Identifier
TEST_SEC	-1	Test Seconds
TIME	"NOT READY"	Time
TIME_DATE	"NOT READY"	Time and Date
TOT_OCTS	"NOT READY"	Total Octets
TX_INFO	"NOT READY"	Transmitter Information Sequence State
UNA_SEC	-1	Unavailable Seconds
V_FR_SEC	-1	Violated Frame Seconds
VCE_TEI	"NOT READY"	Voice Terminal Endpoint Identifier
VF_EAS	-1	Violation Free Error Analysis Seconds
VOICE_STATUS	"NOT READY"	ISDN Voice Call Status
XS0_SEC	-1	Excess Zeros Seconds
YEL_SEC	-1	Yellow Alarm Seconds

Example:

```
>RESULT? BIT_ERRS      requests value of bit errors
-1                      shows that BIT_ERRS are not ready
```

**STATUS COMMANDS**

The STATUS commands and queries are used to set and read the status reporting registers, queues, and buffers. For additional information see Status Registers, found later in this section.

The STATUS commands and queries are:

Command	Query
STATUS:CLEAR_ERR STATUS:CLEAR_PRINT	STATUS:ERROR?
STATUS:INTF_HIST_EN	STATUS:INTF? STATUS:INTF_HIST? STATUS:INTF_HIST_EN?
STATUS:INTF_LOSS_EN	STATUS:INTF_LOSS? STATUS:INTF_LOSS_EN?
STATUS:LINE_HIST_EN	STATUS:LINE? STATUS:LINE_HIST? STATUS:LINE_HIST_EN?
STATUS:LINE_LOSS_EN	STATUS:LINE_LOSS? STATUS:LINE_LOSS_EN?
	STATUS:PRINT?

**CLEAR\_ERR**

---

**Clear Error Queue**

**command**

**STATUS:CLEAR\_ERR** clear the error message queue

Example:

>**STATUS:ERROR?** requests the latest error message  
 "ERROR(107): Unrecognized Command"

>**STATUS:CLEAR\_ERR** clear the error message

>**STATUS:ERROR?** requests the most recent error message  
 "No Errors"

**CLEAR\_PRINT**

---

**Clear Print Buffer**

**command**

**STATUS:CLEAR\_PRINT** clear remote control print buffer

Example:

>**STATUS:CLEAR\_PRINT** clear the RC print queue

>**STATUS:PRINT?** return the next printout in the remote control buffer  
 "ERROR(219): Print buffer is empty."

**ERROR**

**Error Buffer**

query

**STATUS:ERROR?** return the most recent error message from the error buffer

A complete list of errors messages is located later in this section. If no errors are present in the error buffer, the message **No Error** is returned. The response is an error message enclosed in double quotes.

Example:

>**ASDF** ASDF is an unrecognized command  
 "ERROR(107): Unrecognized command."

>**STATUS:ERROR?** return the most recent error message  
 "ERROR(107): Unrecognized command."

**INTF**

**Interface Status Register**

query

**STATUS:INTF?** requests the current value of the Interface Status Register

This register provides the status of various DTE/DCE signaling leads. A one (1) in any bit position indicates that the corresponding signaling lead is active. When read, the value returned is the total weight of the bits that are set high. Table 4-8 describes the standard bit settings for the Interface Status Register, along with their corresponding weight values. This status register is also described later in this section.

**NOTE:** The bit settings shown in Table 4-8 do not apply to the DDS Local Loop Interface (Model 41131/41231). Please see Section 3 of the *DDS Local Loop Interface Manual* for a description of the bit settings that are valid for this interface.

**Table 4-8**  
**Interface Status Register**

Bit:	Weight:	Name:	Meaning:
7	128	—	Not used. Always set to zero.
6	64	—	Not used. Always set to zero.
5	32	DSR/DTR	Set to one when the DSR (DCE emulation) or DTR (DTE emulation) signaling switch is set to ON.
4	16	RLSD/RTS	Set to one when the RLSD (DCE emulation) or RTS (DTE emulation) signaling switch is set to ON.
3	8	RL/TM	Set to one when the RL (DCE emulation) or TM (DTE emulation) is set high.
2	4	LL/CTS	Set to one when the LL (DCE emulation) or CTS (DTE emulation) is set high.
1	2	DTR/DSR	Set to one when the DTR (DCE emulation) or DSR (DTE emulation) is set high.
0	1	RTS/RLSD	Set to one when the RTS (DCE emulation) or RLSD (DTE emulation) is set high.

Example:

```
>STATUS:INTF?      read Interface Status Register
2                  assuming the FIREBERD is emulating a DCE, the value of 2 indicates that the DTR
                  signaling lead is set high
```

**INTF\_HIST**

**Interface History Status Register**

query

**STATUS:INTF\_HIST?** requests the current value of the Interface History Status Register

This register provides a history of DTE/DCE signaling leads that have switched from off to on since this register was last read. When read, the value returned is the total weight of the bits set high (i.e., 1) at the time the byte is read. Reading the register resets all bits to zero. Table 4-9 contains information on each bit and bit weight in the Interface History Status Register. Note that this status register is described later in this section.

**Table 4-9**  
**Interface History Status Register**

Bit:	Weight:	Name:	Meaning:
7	128	—	Not used. Always set to zero.
6	64	—	Not used. Always set to zero.
5	32	DSR/DTR	Set to one when the DSR (DCE emulation) or DTR (DTE emulation) signaling switch is set from OFF to ON.
4	16	RLSD/RTS	Set to one when the RLSD (DCE emulation) or RTS (DTE emulation) signaling switch is set from OFF to ON.
3	8	RL/TM	Set to one when the RL (DCE emulation) or TM (DTE emulation) is set from low to high.
2	4	LL/CTS	Set to one when the LL (DCE emulation) or CTS (DTE emulation) is set from low to high.
1	2	DTR/DSR	Set to one when the DTR (DCE emulation) or DSR (DTE emulation) is set from low to high.
0	1	RTS/RLSD	Set to one when the RTS (DCE emulation) or RLSD (DTE emulation) is set from low to high.

Example:

```
>STATUS:INTF_HIST? read Interface History Status Register
2                  assuming the FIREBERD is emulating a DCE, the value of 2 indicates that the DTR
                  signaling lead is set high
```

## INTF\_HIST\_EN

Set Enable Mask

command/query

**STATUS:INTF\_HIST\_EN (mask)** set the Interface History Enable Status Register**STATUS:INTF\_HIST\_EN?** return the value of the Interface History Enable Status Register

The Interface History Enable Register determines how the Interface Summary bit of the Status Byte Register is set. The Interface Summary bit is set when corresponding bits in the Interface History Register and the Interface History Enable Register are set.

The Interface History Enable Status Register contains a mask value for the bits to be enabled in the Interface History Register. Table 4-10 describes the Interface History Enable Status Register. Note that this status register is described again later in this section.

**Table 4-10**  
**Interface History Enable Status Register**

Bit:	Weight:	Name:	Meaning:
7	128	—	Not used. Always set to zero.
6	64	—	Not used. Always set to zero.
5	32	DSR/DTR	Set to one when the DSR (DCE emulation) or DTR (DTE emulation) signaling switch is set from OFF to ON.
4	16	RLSD/RTS	Set to one when the RLSD (DCE emulation) or RTS (DTE emulation) signaling switch is set from OFF to ON.
3	8	RL/TM	Set to one when the RL (DCE emulation) or TM (DTE emulation) is set from low to high.
2	4	LL/CTS	Set to one when the LL (DCE emulation) or CTS (DTE emulation) is set from low to high.
1	2	DTR/DSR	Set to one when the DTR (DCE emulation) or DSR (DTE emulation) is set from low to high.
0	1	RTS/RLSD	Set to one when the RTS (DCE emulation) or RLSD (DTE emulation) is set from low to high.

Example:

**>STATUS:INTF\_HIST\_EN 7** assuming the FIREBERD is emulating a DTE, the value of 7 enables the CTS, DSR, and RLSD signaling leads to set the Interface Summary bit (4 + 2 + 1)

**>STATUS:INTF\_HIST\_EN?** read the Interface History Enable Register  
7 the Interface Summary bit is set if the CTS, DSR, or RLSD bits are set in the Interface History Register

**INTF\_LOSS**

**Read Interface Loss Register**

**query**

**STATUS:INTF\_LOSS?** requests the current value of the Interface Loss Status Register

This register provides a history of signaling leads that have switched from on to off. A bit is set if this event has occurred since this register was last read. Table 4-11 describes the Interface Loss Status Register. Note that this status register is described again later in this section.

**Table 4-11  
Interface Loss Status Register**

Bit:	Weight:	Name:	Meaning:
7	128	—	Not used. Always set to zero.
6	64	—	Not used. Always set to zero.
5	32	DSR/DTR	Set to one when the DSR (DCE emulation) or DTR (DTE emulation) signaling switch is set from OFF to ON.
4	16	RLSD/RTS	Set to one when the RLSD (DCE emulation) or RTS (DTE emulation) is set from low to high.
3	8	RL/TM	Set to one when the RL (DCE emulation) or TM (DTE emulation) is set from high to low.
2	4	LL/CTS	Set to one when the LL (DCE emulation) or CTS (DTE emulation) is set from high to low.
1	2	DTR/DSR	Set to one when the DTR (DCE emulation) or DSR (DTE emulation) is set from high to low.
0	1	RTS/RLSD	Set to one when the RTS (DCE emulation) or RLSD (DTE emulation) is set from high to low.

Example:

```
>STATUS:INTF_LOSS?      read Interface Loss Status Register
4                        assuming the FIREBERD is emulating a DTE, the value of 4 indicates that the CTS
                        signaling lead was switched from on to off since this register was last read
```

**INTF\_LOSS\_EN**

**Set Enable Mask**

**command/query**

**STATUS:INTF\_LOSS\_EN (mask)** set the Interface Loss Enable Status Register

**STATUS:INTF\_LOSS\_EN?** return the value of the Interface Loss Enable Status Register

The Interface Loss Enable Register determines how the Interface Summary bit of the Status Byte Register is set. The Interface Summary bit is set when corresponding bits in the Interface History Register and the Interface History Enable Register are set.

The Interface Loss Enable Status Register contains a mask value for the bits to be enabled in the Interface Loss Register. Table 4-12 describes the Interface Loss Enable Status Register. Note that this status register is described again later in this section.

**Table 4-12**  
**Interface Loss Enable Status Register**

Bit:	Weight:	Name:	Meaning:
7	128	—	Not used. Always set to zero.
6	64	—	Not used. Always set to zero.
5	32	DSR/DTR	Set to one when the DSR (DCE emulation) or DTR (DTE emulation) signaling switch is set from ON to OFF.
4	16	RLSD/RTS	Set to one when the RLSD (DCE emulation) or RTS (DTE emulation) signaling switch is set from ON to OFF.
3	8	RL/TM	Set to one when the RL (DCE emulation) or TM (DTE emulation) is set from high to low.
2	4	LL/CTS	Set to one when the LL (DCE emulation) or CTS (DTE emulation) is set from high to low.
1	2	DTR/DSR	Set to one when the DTR (DCE emulation) or DSR (DTE emulation) is set from high to low.
0	1	RTS/RLSD	Set to one when the RTS (DCE emulation) or RLSD (DTE emulation) is set from high to low.

Example:

**>STATUS:INTF\_LOSS\_EN 7** assuming the FIREBERD is emulating a DTE, the value of 7 enables the CTS, DSR, and RLSD signaling leads to set the Interface Summary bit (4 + 2 + 1).

**>STATUS:INTF\_LOSS\_EN?** read the Interface Loss Enable Register  
7 the Interface Summary bit is set if the CTS, DSR, or RLSD bits are set in the Interface Loss Register

## LINE

### Line Status Register

query

**STATUS:LINE?** requests the current value of the Line Status Register

This register provides the current state of various signal indicators. When read, the value returned is the total weight of the bits that are high (i.e., set to 1) at the time the byte is read. Table 4-13 describes each bit in the Line Status Register and its corresponding weight value. Note that this status register is described again later in this section.



**Table 4-13  
Line Status Register**

Bit:	Weight:	Name:	Meaning:
7	128	—	Not used. Always set to zero.
6	64	TEST COMPLETE	Set to one when the test is complete.
5	32	RCV CLK INV	Set to one when an inverted clock is received.
4	16	RCV DATA INV	Set to one when inverted data is received.
3	8	GEN CLK PRES	Set to one when generated clock is present.
2	4	PATTERN SYNC	Set to one when pattern sync is achieved.
1	2	FRAME SYNC	Set to one when frame sync is achieved.
0	1	SIGNAL PRESENT	Set to one when signal activity is detected at the input.

Example:

```
>STATUS:LINE?          read line status register
37                      the value of 37 indicates that the FIREBERD 6000 is receiving an inverted clock, is in pattern
                        sync, and detects signal presence (37 = 32 + 4 + 1)
```

**LINE\_HIST**

**Line History Status Register**

**query**

```
STATUS:LINE_HIST?      requests the value of the Line History Status Register
```

This register provides a history of signal indicators that have switched from off to on since this register was last read. When read, the value returned is the total weight of the bits that are high (i.e., set to 1). Reading the register resets all bits to zero. Table 4-14 contains information on each bit and bit weight in the Line History Status Register. Note that this status register is described again later in this section.

**Table 4-14  
Line History Status Register**

Bit:	Weight:	Name:	Meaning:
7	128	—	Not used. Always set to zero.
6	64	TEST COMPLETE	Set to one when the test is complete.
5	32	RCV CLK INV	Set to one when an inverted clock is received.
4	16	RCV DATA INV	Set to one when inverted data is received.
3	8	GEN CLK PRES	Set to one when generated clock is present.
2	4	PATTERN SYNC	Set to one when pattern sync is achieved.
1	2	FRAME SYNC	Set to one when frame sync is achieved.
0	1	SIGNAL PRESENT	Set to one when signal activity is detected at the input.

Example:

```
>STATUS:LINE_HIST?    read the line history status register
28                    the value 28 indicates that the FIREBERD received inverted data, detected generator clock
                        presence, and achieved pattern sync since this register was last read (28 = 16 + 8 + 4)
```

**LINE\_HIST\_EN****Set Enable Mask****command/query****STATUS:****LINE\_HIST\_EN (mask)** set the Line History Enable Status Register**STATUS:****LINE\_HIST\_EN?** return the value of the Line History Enable Status Register

The Line History Enable Register determines how the Line Summary bit of the Status Byte Register is set. The Line Summary bit is set when corresponding bits in the Line History Register and the Line History Enable Register are set.

The Line History Enable Status Register contains a mask value for the bits to be enabled in the Interface History Register. Table 4-15 describes the Line History Enable Status Register. Note that this status register is described again later in this section.

**Table 4-15**  
**Line History Enable Status Register**

Bit:	Weight:	Name:	Meaning:
7	128	—	Not used. Always set to zero.
6	64	TST COMP	Set to one when the test is complete.
5	32	RCV CLK INV	Set to one when an inverted clock is received.
4	16	RCV DATA INV	Set to one when inverted data is received.
3	8	GEN CLK PRES	Set to one when generated clock is present.
2	4	PATTERN SYNC	Set to one when pattern sync is achieved.
1	2	FRAME SYNC	Set to one when frame sync is achieved.
0	1	SIGNAL PRESENT	Set to one when signal activity is detected at the input.

Example:

>**STATUS:LINE\_HIST\_EN 37** the value of 37 enables inverted clock, pattern sync, and signal presence to set the Line Summary bit (32 + 4 + 1)

>**STATUS:LINE\_HIST\_EN?** read Line History Enable Register  
37 the Line Summary bit is set if the inverted clock, pattern sync, or signal presence bit is set in the Line History Register

**LINE\_LOSS****Read Line Loss Register****query****STATUS:LINE\_LOSS?** requests the current value of the Line Loss Status Register

This register provides a history of signal loss, synchronization loss, and generated clock loss. A bit is set if any of these events have occurred since the register was last read. Table 4-16 describes the Line Loss Status Register. Note that this status register is described again later in this section.

**Table 4-16  
Line Loss Status Register**

Bit:	Weight:	Name:	Meaning:
7	128	—	Not used. Always set to zero.
6	64	—	Not used. Always set to zero.
5	32	—	Not used. Always set to zero.
4	16	—	Not used. Always set to zero.
3	8	GEN CLK LOSS	Generated clock was lost since this register was last read.
2	4	PATTERN SYNC LOSS	Pattern synchronization was lost since this register was last read.
1	2	FRAME SYNC LOSS	Frame synchronization was lost since this register was last read.
0	1	SIGNAL LOSS	Signal presence was lost since this register was last read.

**LINE\_LOSS (Continued)**

**Read Line Loss Register**

**query**

Example:

**>STATUS:LINE\_LOSS?** read the line loss status register  
 14 the value 14 indicates that the FIREBERD lost the generator clock, pattern synchronization, and frame synchronization since this register was last read (14 = 8 + 4 + 2)

**LINE\_LOSS\_EN**

**Set Enable Mask**

**command/query**

**STATUS:LINE\_LOSS\_EN (mask)** set the Line Loss Enable Status Register

**STATUS:LINE\_LOSS\_EN?** return the value of the Line Loss Enable Status Register

The Line Loss Enable Register determines how the Line Summary bit of the Status Byte Register is set. The Line Summary bit is set when corresponding bits in the Line History Register and the Line History Enable Register are set.

The Line Loss Enable Status Register contains a mask value for the bits to be enabled in the Interface History Register. Table 4-17 describes the Line Loss Enable Status Register. Note that this status register is described again later in this section.



## 4.7 STATUS REPORTING

The FIREBERD 6000 uses a set of internal registers, queues, and buffers to store information about test status, line conditions, alarms, error conditions, and printer data. This information can be accessed using some of the FIREBERD queries.

### 4.7.1 Register Groups

The FIREBERD 6000 has four groups of registers: Status Byte Registers, Event Status Registers, Line Status Registers, and Interface Status Registers (Figure 4-1).

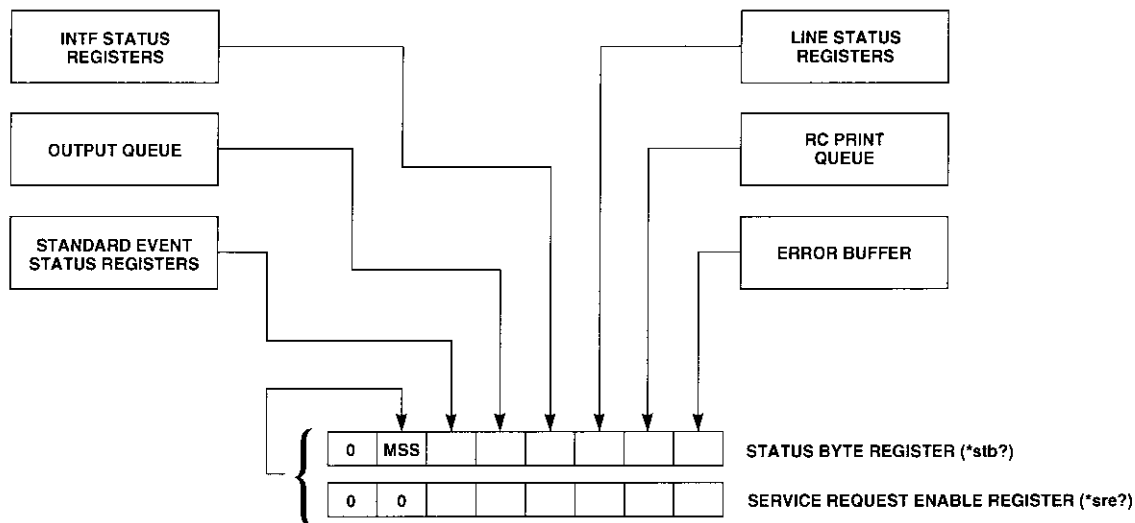

**Figure 4-1**  
**FIREBERD 6000 Registers**

Each group of registers captures specific events. Within each group of registers is a status register which is composed of 8 bits representing up to 8 events. When a specific event occurs, the corresponding bit is set to 1. In this way, the bits in each status register can provide the user with information about the test in progress.

Each group of registers requests both present and past events. Status registers convey present signal status; history and loss registers report changes that have occurred since these registers were last read. A history bit is set when a signal is switched from OFF to ON; a loss bit is set when a signal is switched from ON to OFF.

Additionally, each group of registers contains one or two writable 8-bit enable registers. The bits in each enable register can be programmed to report selected events in the corresponding status register. Setting the bits in the enable register controls the generation of the summary bit for each register group.

The summary bit is set when a status register bit and its corresponding enable register bit are both set. In the Interface and Line Register groups, the summary bit is set when:

- A loss bit and its corresponding loss enable bit are set
- A history bit and its corresponding history enable bit are set

Registers may be read using an associated query. Enable registers may be written to using an associated command. The \*CLS command clears all event registers, buffers, and queues except the output queue.

### An Example of Registers Operation

In Figure 4-2, the value 36 has been written to Enable Register 1. This value sets bits 2 and 5 of Enable Register 1. Since bit 5 of both Status Register 1 and Enable Register 1 is set, the summary bit is set in Status Register 2.

This process is duplicated with each group of registers until all of the summary information is directed to the Status Byte Register. The information contained in the Status Byte register enables the SRQ signal on the IEEE-488 bus. In this way, programmers can have the FIREBERD signal the occurrence of an event of interest.

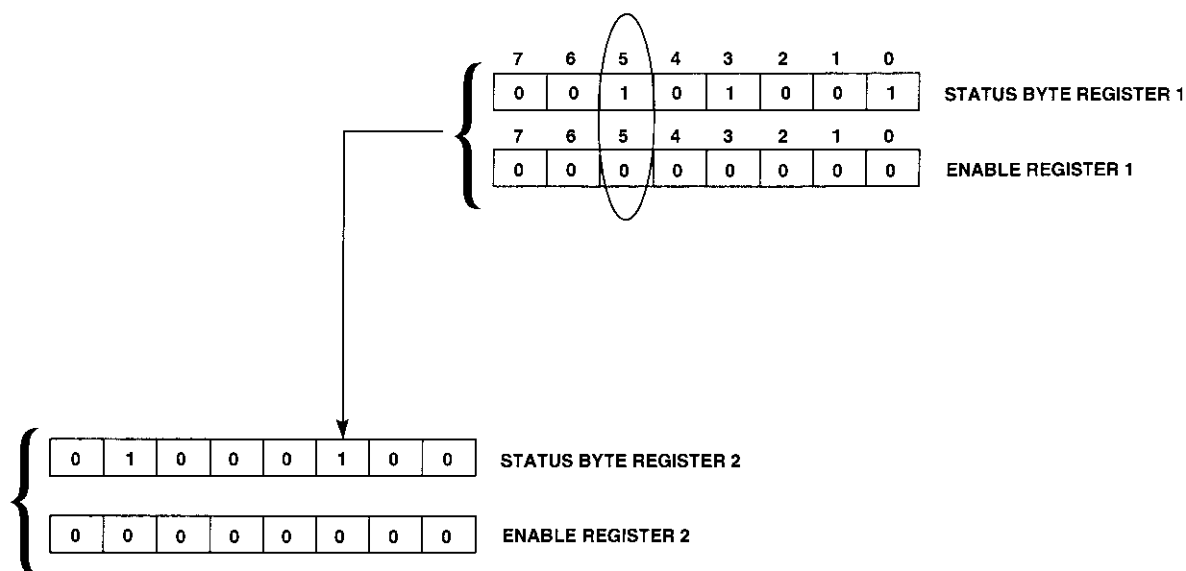

**Figure 4-2**  
**Register Operation**

#### 4.7.2 Queue and Buffer Operation

##### **Output Queue**

All responses generated by the FIREBERD 6000 are placed in the Output Queue. In RS-232 remote control operation, the contents of the Output Queue are immediately transmitted to the terminal. In IEEE-488 remote control operation, responses are stored in the Output Queue until the FIREBERD is addressed to TALK. When a response is in the Output Queue, the Message Available indicator (bit 4 of the Status Byte Register) is set to 1.

##### **Print Queue**

Printouts generated by the FIREBERD 6000 can be sent to an internal buffer called the RC Print Queue. A printout in the RC Print Queue sets the Print Available indicator (bit 1 of the Status Byte Register) to 1. This activity is enabled by setting the printer driver to REMOTE. Printouts are read using the **STATUS:PRINT?** query.

### Error Buffer

The Error Buffer is an internal buffer that stores the last generated error message. It is read using the **STATUS:ERROR?** query and is cleared using the **STATUS:CLEAR\_ERR** command. When an error message is present in the Error Buffer, the Error Available indicator (bit 0 of the Status Byte Register) is set to 1. Errors messages are also transmitted directly to the terminal in RS-232 terminal mode operation.

### 4.7.3 Status Byte Register Group

The Status Byte Register group consists of two 8 bit registers: Status Byte Register and Status Byte Enable Register. This register group summarizes the data structures reporting to it (see Figure 4-3).

### Status Byte Register

The Status Byte Register contains summary bits from the data structures reporting to it. Each bit reports whether a specific event or condition has occurred. The FIREBERD 6000 defines 7 of the 8 bits in the Status Byte Register. The other bit is always set to 0.

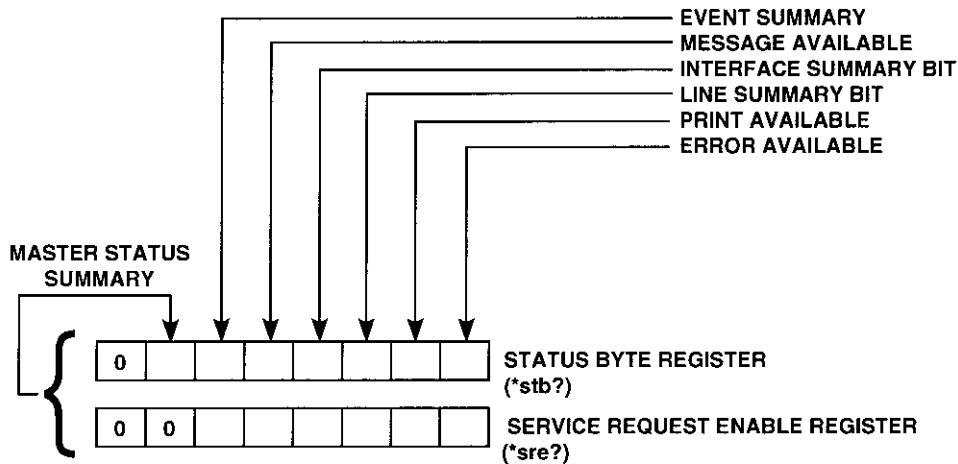

Figure 4-3  
Status Byte Register Group

The controller can read the Status Byte Register using a serial poll or using the **\*STB?** query. When a serial poll is used, bit 6 is returned as a Request Service (RQS); when the **\*STB?** query is used, bit 6 is returned as a Master Summary Status (MSS).

When the Status Byte Register is read, a weighted integer is returned. This integer represents the decimal equivalent of the enabled bits in the register. To determine the status of the bits in the Status Byte Register, convert the returned value to binary.

Bit 7 Not used. Always zero.

Bit 6 **MSS - Master Status Summary**

Represents the summary of all other bits in the Status Byte Register. The corresponding enabling bit in the Service Request Enabling Register (\*SRE) is not programmable. When this bit is set to 1, an SRQ is asserted on the IEEE-488 bus.

- Bit 5 **ESB - Event Status Bit**  
Indicates that an enabled event has occurred in the Standard Event Status Register. Read the Standard Event Status Register to determine the specifics of the event.
- Bit 4 **MAV - Message Available**  
Indicates that a response is available in the output queue. The FIREBERD does not talk on an IEEE-488 bus until the MAV bit is set to 1.
- Bit 3 **INT - Interface Summary Bit**  
Indicates a status change in the Interface Status Register. Read the Interface History and Loss Registers to determine the specifics of the status change.
- Bit 2 **LSB - Line Summary Bit**  
Indicates a status change in the Line Status Register. Read the History and Loss Registers to determine the specifics of the status change.
- Bit 1 **PAB - Print Buffer Available**  
Indicates that a printout is available in the remote control print buffer (see **STATUS:PRINT?**).
- Bit 0 **EAB - Error Buffer Available**  
Indicates that an error message is available in the error buffer (see **STATUS:ERROR?** and **STATUS:CLEAR\_ERR**).

**Status Byte Enable Register**

Status Byte Enable Register is an 8-bit register that determines which bits of the Status Byte Register can cause the MSS bit to be set. The MSS bit is used to assert SRQ when using an IEEE-488 bus. This means that the Service Request Enable register effectively determines when the FIREBERD 6000 requests service. Use the **\*SRE** command to write to the Service Request Enable Register.

**4.7.4 Event Status Register Group**

The Event Status Register group detects specific IEEE-488-defined events (Figure 4-4). It consists of two 8-bit registers: the Event Status Register and the Event Status Enable Register.

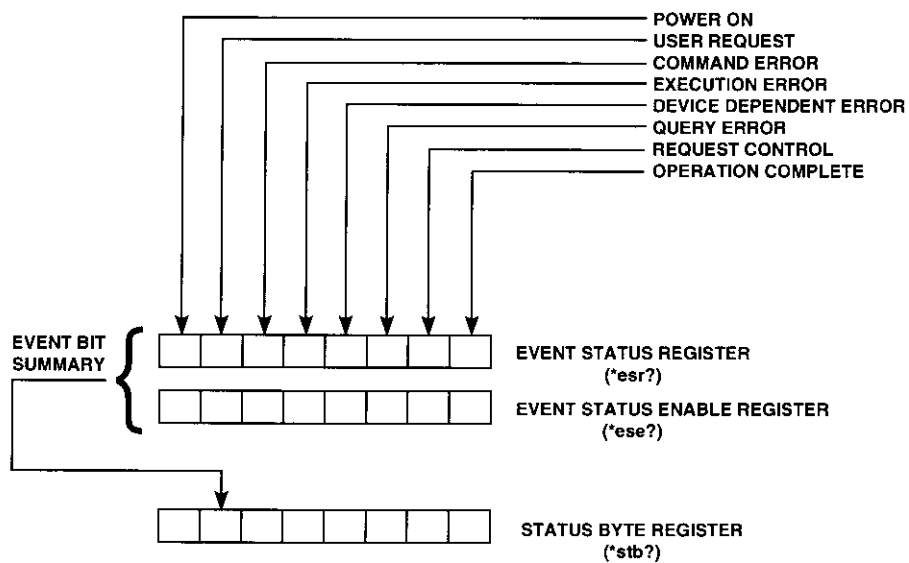

**Figure 4-4**  
**Event Status Register Group**



## Remote Control

### The Event Status Register

The Event Status Register (ESR) assigns specific IEEE-488.2-defined events to each of the bits within the register. A bit is set in the Event Status Register when the event that corresponds to that bit has occurred since the register was last read or cleared. This register is cleared each time it is read.

- Bit 7 **PON - Power On**  
Power has been cycled OFF and ON since the last time the Event Status Register was read.
- Bit 6 **URQ - User Request**  
Not used. Always reads zero.
- Bit 5 **CME - Command Error**  
Indicates that a command received by the FIREBERD 6000 was not executed because it was not understood.
- Bit 4 **EXE - Execution Error**  
Indicates that the FIREBERD is unable to execute a command.
- Bit 3 **DDE - Device-Dependent Error**  
Not used. Always reads zero.
- Bit 2 **QYE - Query Error**  
Indicates that the controller has attempted to read the FIREBERD output queue when nothing was available to be read, or that data in that queue has been lost.
- Bit 1 **RQC - Request Control**  
Not used. Always reads zero.
- Bit 0 **OPC - Operation Complete**  
Indicates that all pending operations are complete (see the \*OPC command).

### The Event Status Enable Register

Event Status Enable Register is an 8-bit register that allows the controller to enable or disable each bit in the Event Status Register. When a bit in the Event Status Enable Register is set to 1, the corresponding bit in the Event Status Register is enabled. When an enabled bit in the Event Status Register is set to 1, the ESB bit in the Status Byte Register is also set to 1.

#### 4.7.5 Line Summary Register Group

The Line Summary Register group consists of 5 registers: the Line Status Register, Line History Register, Line History Enable Register, Line Loss Register, and Line Loss Enable Register (Figure 4-5).

### The Line Status Register

The Line Status Register gives the current state of various signal indicators. The Line Status Register is read using the query: **STATUS:LINE?**.

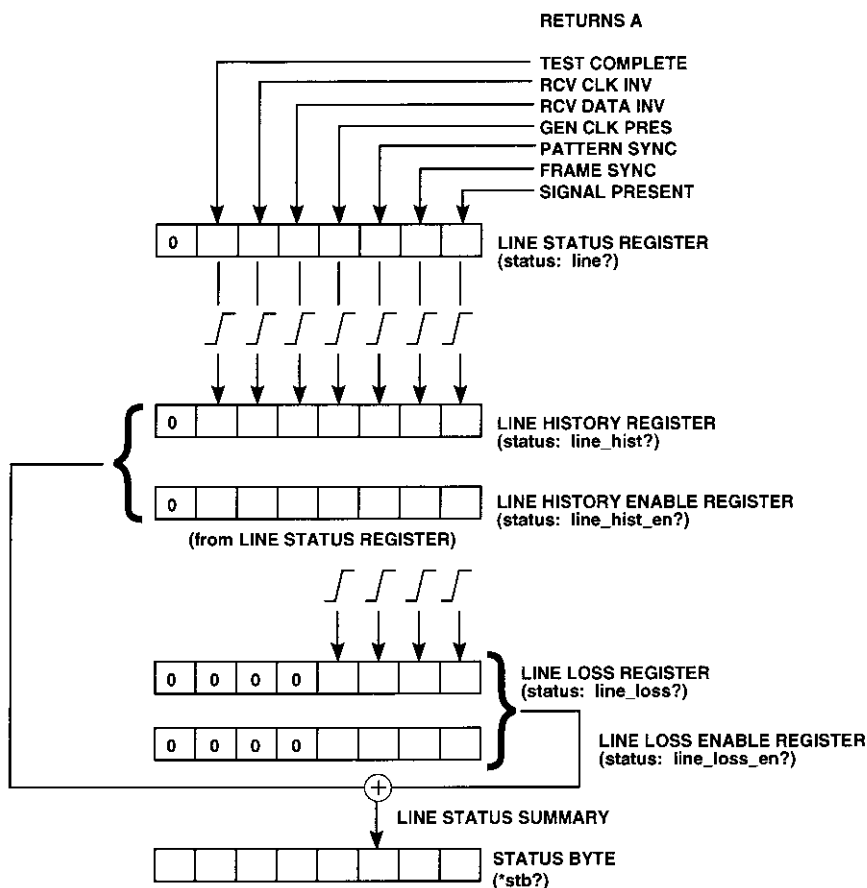

**Figure 4-5**  
**Line Summary Register Group**

- Bit 7 Not used. Always 0.
- Bit 6 **TEST COMPLETE**  
Set to 1 when the test is complete.
- Bit 5 **RCV CLK INV**  
Set to 1 when an inverted clock is received.
- Bit 4 **RCV DATA INV**  
Set to 1 when inverted data is received.
- Bit 3 **GEN CLK PRES**  
Set to 1 when generated clock is present.
- Bit 2 **PATTERN SYNC**  
Set to 1 when pattern sync is achieved.
- Bit 1 **FRAME SYNC**  
Set to 1 when the FIREBERD detects frame synchronization.
- Bit 0 **SIGNAL PRESENT**  
Set to 1 when an input signal is present.

## Remote Control

### The Line History Register

The Line History Register provides the history of various signal indicators since this register was last read. When a bit is set, it indicates that at some point there was no generated clock, pattern sync, frame sync, etc.; and then the clock or sync was gained. This may indicate that during the preceding time interval an error occurred and was then recovered from (e.g., sync was lost and then re-established); or it may indicate a deliberate RESULT RESTART generally indicates that an error has occurred or synchronization was lost during the interval since the register was last read. The Line History Register is read using the query: **STATUS:LINE HIST?**.

- Bit 7 Not used. Always 0.
- Bit 6 **TEST COMPLETE**  
Set to 1 when the test is complete.
- Bit 5 **RCV CLK INV**  
Set to 1 when an inverted clock is received.
- Bit 4 **RCV DATA INV**  
Set to 1 when inverted data is received.
- Bit 3 **GEN CLK PRES**  
Indicates that the generated clock was present since this register was last read.
- Bit 2 **PATTERN SYNC**  
Indicates that the FIREBERD synchronized to the received pattern since this register was last read.
- Bit 1 **FRAME SYNC**  
Indicates that frame synchronization was detected since this register was last read.
- Bit 0 **SIGNAL PRESENT**  
Indicates that signal presence was detected since this register was last read.

### The Line History Enable Register

The Line History Enable Register determines how the Line Summary bit of the Status Byte Register is set. The Line Summary bit is set when corresponding bits in the Line History Register and the Line History Enable Register are set. The Line History Enable Register is read with the query: **STATUS:LINE\_HIST\_EN?**.

### The Line Loss Register

The Line Loss Register provides a history of signal loss, synchronization loss, and generated clock loss. A bit is set if any of these events have occurred since the register was last read. The Line Loss Register is read using the query **STATUS:LINE\_LOSS?**.

- Bit 7 Not used. Always set to zero.
- Bit 6 Not used. Always set to zero.
- Bit 5 Not used. Always set to zero.
- Bit 4 Not used. Always set to zero.
- Bit 3 **GEN CLK LOSS**  
Indicates that the generated clock was lost since this register was last read.

- Bit 2 **PATTERN SYNC LOSS**  
Indicates that the FIREBERD lost synchronization to the received pattern since this register was last read.
- Bit 1 **FRAME SYNC LOSS**  
Indicates that frame synchronization was lost since this register was last read.
- Bit 0 **SIGNAL LOSS**  
Indicates that signal presence was lost since this register was last read.

### The Line Loss Enable Register

The Line Loss Enable Register determines how the Line Summary bit of the Status Byte Register is set. The Line Summary bit is set when corresponding bits in the Line Loss Register and the Line Loss Enable Register are set. Thus, either the Line History Register or Line Loss Register determine how the Line Summary bit is set. The Line Loss Enable Register is read using the query **STATUS:LINE\_LOSS\_EN?**.

#### 4.7.6 Interface Status Register Group

The Interface Status Register group consists of 5 registers: the Interface Status Register, Interface History Register, Interface History Enable Register, Interface Loss Register, and Interface Loss Enable Register (Figure 4-6).

### The Interface Status Register

The Interface Status Register indicates the current status of the interface signal. A 1 in any bit position indicates that the corresponding signal is active. The Interface Status Register is read using the query: **STATUS:INTF?**.

**NOTE:** The bit settings immediately following do not apply to the DDS Local Loop Interface (Model 41131/41231). Refer to Section 3 of the *DDS Local Loop Interface Manual* for a description of the bit settings that are valid for this interface.

- Bit 7 Not used. Always 0.
- Bit 6 Not used. Always 0.
- Bit 5 **DSR/DTR**  
Set to 1 when the DSR (DCE emulation) or DTR (DTE emulation) signaling switch is set to ON.
- Bit 4 **RLSD/RTS**  
Set to 1 when the RLSD (DCE emulation) or RTS (DTE emulation) signaling switch is set to ON.
- Bit 3 **RL/TM**  
Set to 1 when the RL (DCE emulation) or TM (DTE emulation) signaling lead is set high.
- Bit 2 **LL/CTS**  
Set to 1 when the LL (DCE emulation) or CTS (DTE emulation) signaling lead is set high.
- Bit 1 **DTR/DSR**  
Set to 1 when the DTR (DCE emulation) or DSR (DTE emulation) signaling lead is set high.
- Bit 0 **RTS/RLSD**  
Set to 1 when the RTS (DCE emulation) or RLSD (DTE emulation) signaling lead is set high.

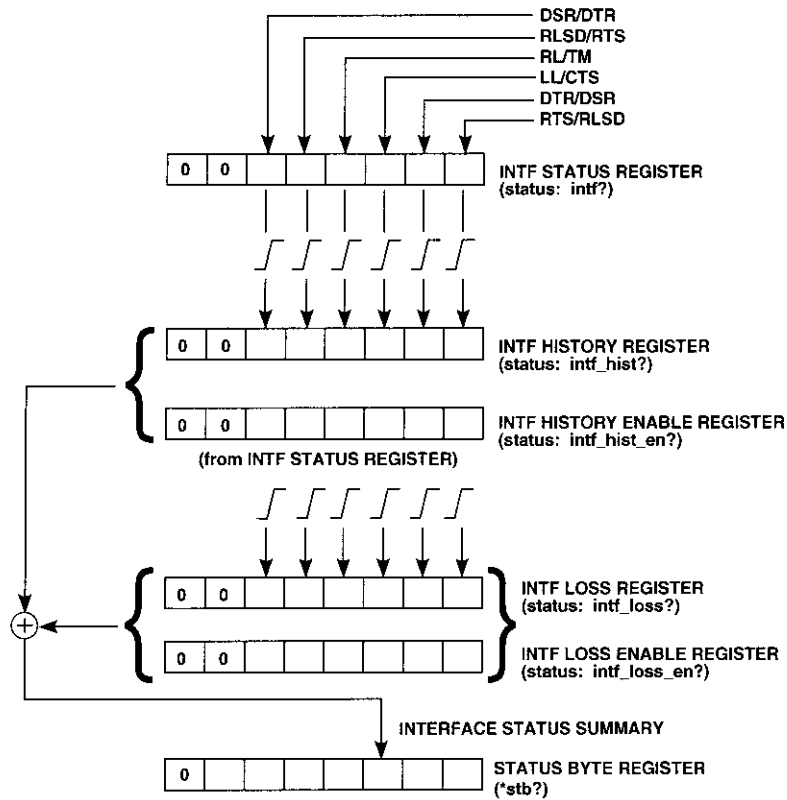

**Figure 4-6**  
**Interface Status Register**

### The Interface History Register

The Interface History Register provides the history of the interface signal since this register was last read. A bit in this register is set when the corresponding bit in the Interface Status Register changes from 0 (idle) to 1 (active). The bit in the Interface History Register remains set until this register is read. The Interface History Register is read using the query: **STATUS:INTF\_HIST?**.

Bit 7 Not used. Always 0.

Bit 6 Not used. Always 0.

Bit 5 **DSR/DTR**  
Set to 1 when the DSR (DCE emulation) or DTR (DTE emulation) signaling switch is set to ON.

Bit 4 **RLSD/RTS**  
Set to 1 when the RLSD (DCE emulation) or RTS (DTE emulation) signaling switch is set to ON.

Bit 3 **RL/TM**  
Set to 1 when the RL (DCE emulation) or TM (DTE emulation) signaling lead is set high.

Bit 2 **LL/CTS**  
Set to 1 when the LL (DCE emulation) or CTS (DTE emulation) signaling lead is set high.

Bit 1 **DTR/DSR**  
Set to 1 when the DTR (DCE emulation) or DSR (DTE emulation) signaling lead is set high.

Bit 0 **RTS/RLSD**  
Set to 1 when the RTS (DCE emulation) or RLSD (DTE emulation) signaling lead is set high.

### The Interface History Enable Register

The Interface History Enable Register determines how the Interface Summary bit of the Status Byte Register is set. The Interface Summary bit is set when corresponding bits in the Interface History Register and the Interface History Enable Register are set. The Interface History Enable Register is read with the query: **STATUS:INTF\_HIST\_EN?**

### The Interface Loss Register

The Interface Loss Register provides a history of interface signal losses. A bit is set if any interface signal has been lost since the register was last read. The Interface Loss Register is read using the query **STATUS:INTF\_LOSS?**

Bit 7 Not used. Always 0.

Bit 6 Not used. Always 0.

Bit 5 **DSR/DTR**

Set to 1 when the DSR (DCE emulation) or DTR (DTE emulation) signaling switch goes from ON to OFF.

Bit 4 **RLSD/RTS**

Set to 1 when the RLSD (DCE emulation) or RTS (DTE emulation) signaling switch goes from ON to OFF.

Bit 3 **RL/TM**

Set to 1 when the RL (DCE emulation) or TM (DTE emulation) signaling lead goes from high to low.

Bit 2 **LL/CTS**

Set to 1 when the LL (DCE emulation) or CTS (DTE emulation) signaling lead goes from high to low.

Bit 1 **DTR/DSR**

Set to 1 when the DTR (DCE emulation) or DSR (DTE emulation) signaling lead goes from high to low.

Bit 0 **RTS/RLSD**

Set to 1 when the RTS (DCE emulation) or RLSD (DTE emulation) signaling lead goes from high to low.

### The Interface Loss Enable Register

The Interface Loss Enable Register determines how the Interface Summary bit of the Status Byte Register is set. The Interface Summary bit is set when corresponding bits in the Interface Loss Register and the Interface Loss Enable Register are set. Thus, either the Interface History Register or Interface Loss Register determine how the Interface Summary bit is set.

## 4.8 ERROR MESSAGES

An error message indicates an error in an unprocessed remote control command. Error messages are generated according to the FIREBERD 6000 remote control mode of choice: RS-232 terminal, RS-232 computer, or IEEE-488.

### RS-232 Terminal Mode

In terminal mode, the FIREBERD operates interactively. Therefore, error messages are transmitted to the terminal as soon as they occur. The error message is also placed in the error buffer, causing the Error Available indicator (bit 0 of the Status Byte Register) to be set.

## **Remote Control**

### **RS-232 Computer Mode**

In computer mode, the FIREBERD operates with a programmed computer which requires predictable results. Therefore, error messages are not sent to the computer when they occur, but are instead sent to the error buffer. This causes the Error Available indicator (bit 0 of the Status Byte Register) to be set.

### **IEEE-488 Computer Mode**

When the FIREBERD 6000 operates via an IEEE-488 bus, error messages are sent to the error buffer. This causes the Error Available indicator (bit 0 of the Status Byte Register) to be set.

The error buffer holds one error message at a time. The error message currently held is the last error message generated. The error buffer is read using the **STATUS:ERROR?** query and is cleared using the **STATUS:CLEAR\_ERR** command. When an error message is present in the error buffer, the Error Available indicator (bit 0 of the Status Byte Register) is set. In computer mode, error message must be cleared before issuing the next command.

### **4.8.1 Error Messages**

The following is a complete list of error messages reported by the FIREBERD 6000.

#### **Command Errors**

##### **Argument Too Long (100)**

Cause: An invalid command argument is specified.

##### **Invalid Argument (101)**

Cause: A command argument that does not match the expected argument syntax is specified.

##### **Invalid Hexadecimal Argument (102)**

Cause: A command argument that does not match the syntax of the expected hexadecimal argument is specified.

##### **Invalid Numeric Argument (103)**

Cause: The FIREBERD does not recognize the argument entered in the command line because it is not in numeric format.

##### **String Argument Expected (104)**

Cause: A command is issued without the argument enclosed in quotes.

##### **String Too Long (105)**

Cause: A specified command contains a string with more than 254 characters.

##### **Syntax Error (106)**

Cause: The FIREBERD does not recognize the input as a valid command. This error message may appear when a comma or semicolon is missing, or when a command is misspelled.

##### **Unrecognized Command (107)**

Cause: An unrecognizable command or query was received.

#### **Execution Errors**

##### **An empty slot cannot be selected (200)**

Cause: The specified interface slot is empty.

##### **Asynchronous frequency contention (201)**

Cause: The specified frequency is invalid in asynchronous timing mode.

**Asynchronous pattern contention (202)**

Cause: The specified pattern is invalid in asynchronous timing mode.

**Cannot set while line is active (203)**

Cause: A parameter change is not allowed while the line is active.

**Device in use (204)**

Cause: The printer driver specified is also the one used by remote control.

**Illegal phone number (205)**

Cause: The data specified does not constitute a legal phone number.

**Illegal result name (206)**

Cause: The data specified does not constitute a legal result.

**Illegal type name (207)**

Cause: The data specified does not constitute a legal type.

**Illegal user message string (208)**

Cause: The specified user message string is either not in the correct format or contains ASCII characters which are invalid.

**Illegal user message byte position (209)**

Cause: The byte position is not within the boundaries of the specified user message.

**Illegal value (210)**

Cause: The value specified with a command is not within the legal range of the requested function.

**Inconsistent with current configuration (211)**

Cause: The requested function is not applicable in the FIREBERD 6000 current mode.

**Inconsistent with interface or interface mode (212)**

Cause: The requested command is not supported by the current interface, or is not applicable or available in the current interface mode.

**ISU-6000 is installed (213)**

Cause: A command to select the external interface is specified while the ISU-6000 is installed.

**ISU-6000 is not installed (214)**

Cause: An ISU-6000 command is specified when the option is not installed.

**ISU-2000 is not in remote mode (215)**

Cause: A remote command was issued for the ISU-2000 while in local mode.

**Jitter generation contention (216)**

Cause: The command specified caused contention in the jitter generator.

**Option not installed (217)**

Cause: The specified command requires an option that is not installed.

**Presynchronization/power loss unavailable (218)**

Cause: Synchronization losses or power losses have not occurred.

**Print buffer is empty (219)**

Cause: A command to read the print buffer is issued when no printouts are available.

**Remote control using RS232 (220)**

Cause: A change in an RS-232 parameter is encountered while remote control is using the RS-232 driver.



## ***Remote Control***

### **Result not applicable (221)**

Cause: The result specified is not applicable in the current timing or interface mode.

### **Software error (222)**

Cause: An internal software error has occurred.

### **Synchronous pattern contention (223)**

Cause: The pattern specified is invalid when synchronous timing is selected.

### **Unrecognized parameter (224)**

Cause: The FIREBERD recognizes but cannot interpret the command parameter specified.

## **Query Errors**

### **Command unterminated (300)**

Cause: The controller tried to read a response before a complete program message had been sent to the FIREBERD. No response is sent.

### **Deadlock detected (301)**

Cause: When a very long program message produces a very long response message, the commands in the input buffer. If this condition occurs, the entire response message is discarded. All commands sent are processed normally.

### **Response interrupted (302)**

Cause: The controller sent the FIREBERD a command or query before reading the entire response from a previous query. The response of the previous query is discarded.

1

2

3  
4  
5  
6  
7  
8  
9  
10  
11  
12  
13  
14  
15  
16  
17  
18  
19  
20  
21  
22  
23  
24  
25  
26  
27  
28  
29  
30  
31  
32  
33  
34  
35  
36  
37  
38  
39  
40  
41  
42  
43  
44  
45  
46  
47  
48  
49  
50  
51  
52  
53  
54  
55  
56  
57  
58  
59  
60  
61  
62  
63  
64  
65  
66  
67  
68  
69  
70  
71  
72  
73  
74  
75  
76  
77  
78  
79  
80  
81  
82  
83  
84  
85  
86  
87  
88  
89  
90  
91  
92  
93  
94  
95  
96  
97  
98  
99  
100  
101  
102  
103  
104  
105  
106  
107  
108  
109  
110  
111  
112  
113  
114  
115  
116  
117  
118  
119  
120  
121  
122  
123  
124  
125  
126  
127  
128  
129  
130  
131  
132  
133  
134  
135  
136  
137  
138  
139  
140  
141  
142  
143  
144  
145  
146  
147  
148  
149  
150  
151  
152  
153  
154  
155  
156  
157  
158  
159  
160  
161  
162  
163  
164  
165  
166  
167  
168  
169  
170  
171  
172  
173  
174  
175  
176  
177  
178  
179  
180  
181  
182  
183  
184  
185  
186  
187  
188  
189  
190  
191  
192  
193  
194  
195  
196  
197  
198  
199  
200  
201  
202  
203  
204  
205  
206  
207  
208  
209  
210  
211  
212  
213  
214  
215  
216  
217  
218  
219  
220  
221  
222  
223  
224  
225  
226  
227  
228  
229  
230  
231  
232  
233  
234  
235  
236  
237  
238  
239  
240  
241  
242  
243  
244  
245  
246  
247  
248  
249  
250  
251  
252  
253  
254  
255  
256  
257  
258  
259  
260  
261  
262  
263  
264  
265  
266  
267  
268  
269  
270  
271  
272  
273  
274  
275  
276  
277  
278  
279  
280  
281  
282  
283  
284  
285  
286  
287  
288  
289  
290  
291  
292  
293  
294  
295  
296  
297  
298  
299  
300  
301  
302  
303  
304  
305  
306  
307  
308  
309  
310  
311  
312  
313  
314  
315  
316  
317  
318  
319  
320  
321  
322  
323  
324  
325  
326  
327  
328  
329  
330  
331  
332  
333  
334  
335  
336  
337  
338  
339  
340  
341  
342  
343  
344  
345  
346  
347  
348  
349  
350  
351  
352  
353  
354  
355  
356  
357  
358  
359  
360  
361  
362  
363  
364  
365  
366  
367  
368  
369  
370  
371  
372  
373  
374  
375  
376  
377  
378  
379  
380  
381  
382  
383  
384  
385  
386  
387  
388  
389  
390  
391  
392  
393  
394  
395  
396  
397  
398  
399  
400  
401  
402  
403  
404  
405  
406  
407  
408  
409  
410  
411  
412  
413  
414  
415  
416  
417  
418  
419  
420  
421  
422  
423  
424  
425  
426  
427  
428  
429  
430  
431  
432  
433  
434  
435  
436  
437  
438  
439  
440  
441  
442  
443  
444  
445  
446  
447  
448  
449  
450  
451  
452  
453  
454  
455  
456  
457  
458  
459  
460  
461  
462  
463  
464  
465  
466  
467  
468  
469  
470  
471  
472  
473  
474  
475  
476  
477  
478  
479  
480  
481  
482  
483  
484  
485  
486  
487  
488  
489  
490  
491  
492  
493  
494  
495  
496  
497  
498  
499  
500  
501  
502  
503  
504  
505  
506  
507  
508  
509  
510  
511  
512  
513  
514  
515  
516  
517  
518  
519  
520  
521  
522  
523  
524  
525  
526  
527  
528  
529  
530  
531  
532  
533  
534  
535  
536  
537  
538  
539  
540  
541  
542  
543  
544  
545  
546  
547  
548  
549  
550  
551  
552  
553  
554  
555  
556  
557  
558  
559  
560  
561  
562  
563  
564  
565  
566  
567  
568  
569  
570  
571  
572  
573  
574  
575  
576  
577  
578  
579  
580  
581  
582  
583  
584  
585  
586  
587  
588  
589  
590  
591  
592  
593  
594  
595  
596  
597  
598  
599  
600  
601  
602  
603  
604  
605  
606  
607  
608  
609  
610  
611  
612  
613  
614  
615  
616  
617  
618  
619  
620  
621  
622  
623  
624  
625  
626  
627  
628  
629  
630  
631  
632  
633  
634  
635  
636  
637  
638  
639  
640  
641  
642  
643  
644  
645  
646  
647  
648  
649  
650  
651  
652  
653  
654  
655  
656  
657  
658  
659  
660  
661  
662  
663  
664  
665  
666  
667  
668  
669  
670  
671  
672  
673  
674  
675  
676  
677  
678  
679  
680  
681  
682  
683  
684  
685  
686  
687  
688  
689  
690  
691  
692  
693  
694  
695  
696  
697  
698  
699  
700  
701  
702  
703  
704  
705  
706  
707  
708  
709  
710  
711  
712  
713  
714  
715  
716  
717  
718  
719  
720  
721  
722  
723  
724  
725  
726  
727  
728  
729  
730  
731  
732  
733  
734  
735  
736  
737  
738  
739  
740  
741  
742  
743  
744  
745  
746  
747  
748  
749  
750  
751  
752  
753  
754  
755  
756  
757  
758  
759  
760  
761  
762  
763  
764  
765  
766  
767  
768  
769  
770  
771  
772  
773  
774  
775  
776  
777  
778  
779  
780  
781  
782  
783  
784  
785  
786  
787  
788  
789  
790  
791  
792  
793  
794  
795  
796  
797  
798  
799  
800  
801  
802  
803  
804  
805  
806  
807  
808  
809  
810  
811  
812  
813  
814  
815  
816  
817  
818  
819  
820  
821  
822  
823  
824  
825  
826  
827  
828  
829  
830  
831  
832  
833  
834  
835  
836  
837  
838  
839  
840  
841  
842  
843  
844  
845  
846  
847  
848  
849  
850  
851  
852  
853  
854  
855  
856  
857  
858  
859  
860  
861  
862  
863  
864  
865  
866  
867  
868  
869  
870  
871  
872  
873  
874  
875  
876  
877  
878  
879  
880  
881  
882  
883  
884  
885  
886  
887  
888  
889  
890  
891  
892  
893  
894  
895  
896  
897  
898  
899  
900  
901  
902  
903  
904  
905  
906  
907  
908  
909  
910  
911  
912  
913  
914  
915  
916  
917  
918  
919  
920  
921  
922  
923  
924  
925  
926  
927  
928  
929  
930  
931  
932  
933  
934  
935  
936  
937  
938  
939  
940  
941  
942  
943  
944  
945  
946  
947  
948  
949  
950  
951  
952  
953  
954  
955  
956  
957  
958  
959  
960  
961  
962  
963  
964  
965  
966  
967  
968  
969  
970  
971  
972  
973  
974  
975  
976  
977  
978  
979  
980  
981  
982  
983  
984  
985  
986  
987  
988  
989  
990  
991  
992  
993  
994  
995  
996  
997  
998  
999  
1000

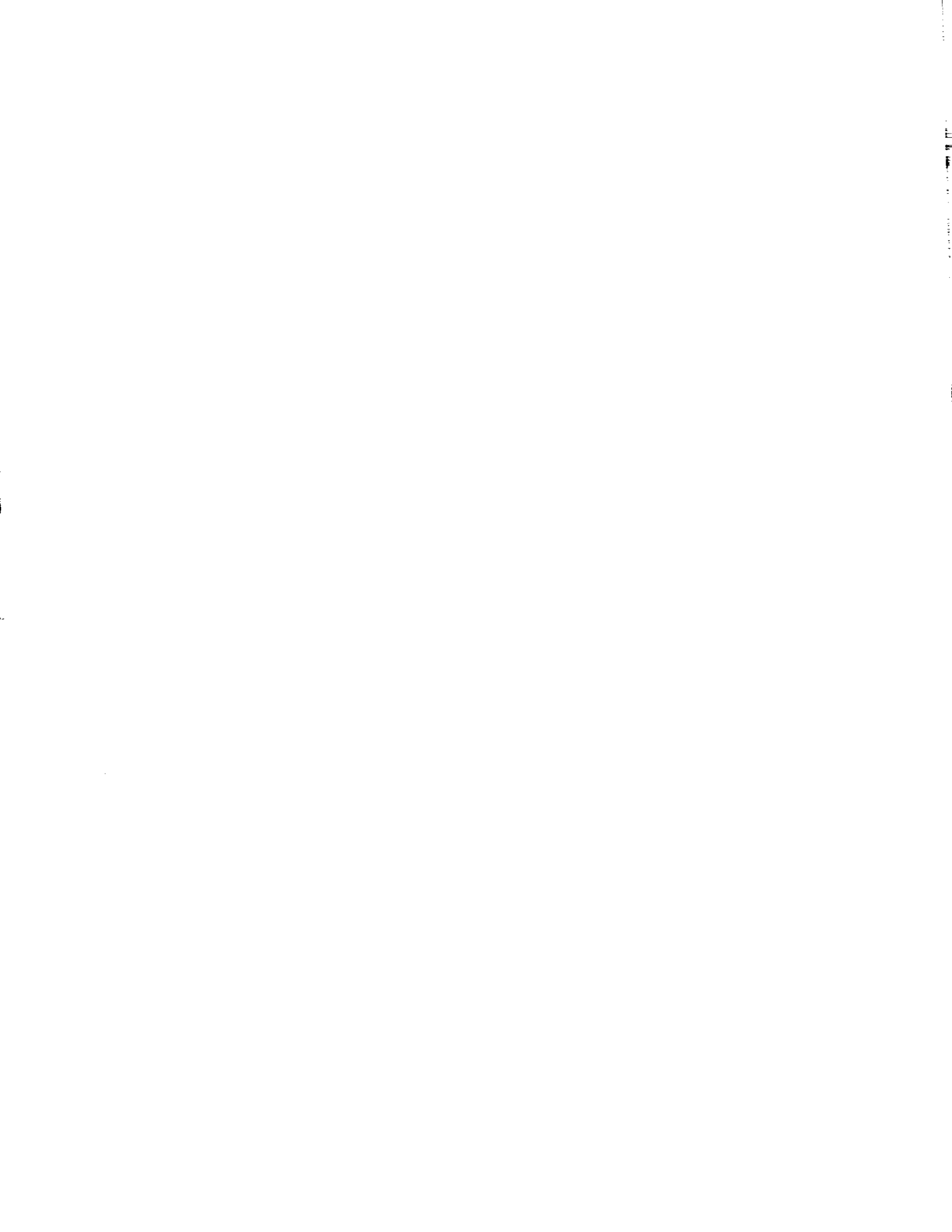

## SECTION 5 OPTIONS AND ACCESSORIES

### 5.1 SECTION SUMMARY

This section describes some of the options and accessories available for use with the FIREBERD 6000. Specifically described are the Metal Case and Remote Control options and such accessories as the printers, rack mounts, and carrying cases. This section also includes, for ordering purposes, a list of all accessories available (including cables and data interfaces) with their corresponding model numbers.

### 5.2 OPTIONS

Various hardware and software options are available for the FIREBERD 6000. Two of these, the Metal Case option and the Remote Control option, are described in the following paragraphs. The other available options are discussed in detail elsewhere in this manual. Section 5.2.3 lists these options and their model numbers.

#### 5.2.1 FIREBERD MC6000 (Metal Case Option)

The FIREBERD MC6000 is the ruggedized version of the standard FIREBERD 6000. Performance characteristics, front and rear panel formats, and internal electronic sub-assemblies are identical.

The FIREBERD MC6000 housing is of metal construction and quite rugged. The unit comes with a front snap-on cover. With the cover in place, the instrument is completely protected and can be carried and handled like a piece of luggage. The manual or two extra interface modules can be stored in the snap-on back pouch.

The FIREBERD MC6000 is 6 1/2" high (including the feet), 14 1/2" wide and 14" deep (including the cover). The unit weighs approximately 19 pounds, 3 ounces with interface, all options, front cover, and power cord.

#### 5.2.2 FIREBERD 6000R (Remote Control Communications Analyzer)

The FIREBERD 6000R has all of the capability of the FIREBERD 6000, but it will operate only under remote control. It is packaged in the FIREBERD 6000 plastic case but has a blank front panel with only a power switch and an indicator that lights while the FIREBERD is being remotely controlled. It weighs 19 pounds with all options, a data interface, and the IEEE-488 Remote Control Interface installed.

## Options and Accessories

### 5.2.3 Options List

The following is a list of other available options and their part numbers. Listed in parentheses next to each option is the location in this manual of a description of the option.

<b>Option Number:</b>	<b>Description:</b>	<b>Location:</b>
6001	DS1 Wideband Jitter Measurement	(Appendix B)
6002	DS1 Jitter Spectral Analysis	(Appendix B)
6003	DS1 Jitter Generation	(Appendix B)
6004	Clock Recovery	(Section 2)
6005	IEEE-488 Remote Control/Printer Interface	(Section 4)
6006	Precision Time Base (1ppm)	(Section 2)
6007	G.703 64 kb/s and 2048 kb/s Wideband Jitter Generation and Measurement	(Appendix B)
6008	G.703 64 kb/s and 2048 kb/s Jitter Spectral Analysis	(Appendix B)
6009	ANSI T1.403 Performance Report Messages (PRMs)	(T1/FT1 Intf. Manual)
6010	Frame Relay	(Appendix F)
6011	Frame Relay Retrofit	(Appendix F)

## 5.3 ACCESSORIES

Various accessories for the FIREBERD 6000 are described below. Also included are instructions for those accessories requiring installation.

### 5.3.1 Interface Modules

The FIREBERD 6000 can support only one optional interface module at a time. However, if two ISUs are used, the number of interface modules supported can be up to 8. This allows the user to choose one of several interfaces without having to remove an installed interface module and install another. The following list describes the interface module, when it is used, and applicable specifications to which the interface conforms.

#### FIREBERD 6000 Data Interfaces

<b>Model Number:</b>	<b>Manual Number:</b>	<b>Interface Label:</b>	<b>Description:</b>
30608	ML10898	64G703	CCITT G.703 64 kb/s Data Interface — Meets CCITT Recommendation G.703 for testing either co-directional or contra-directional communications equipment operating at 64 kb/s.
41800	ML12028	2M/n64	2M/n64 Data Interface — Complies with CCITT Recommendations G.703, G.704, G.732, G.821, G.823, O.161, and O.171 for framed or unframed data.
30609	ML10899	2MG704	CCITT G.704 2048 kb/s Data Interface — Meets CCITT Recommendation G.703 and G.704 for testing communications equipment operating at 2048 kb/s.
30524	ML10706	8MG703	CCITT G.703 8448 kb/s Data Interface — Meets CCITT Recommendation G.703 for testing communications equipment operating at 8448 kb/s.

## FIREBERD 6000 Data Interfaces (Continued)

<u>Model Number:</u>	<u>Manual Number:</u>	<u>Interface Label:</u>	<u>Description:</u>
41131	ML11319	DDS	DDS LOCAL LOOP Interface — meets requirements for testing Digital Data Service (DDS) equipment connections to the local loop. Tests at rates from 2.4 to 56 kb/s with secondary channel capability.
30678	ML11033	DS0A/B	DDS DS0A/DS0B Data Interface — Meets Bellcore and AT&T requirements for DDS testing at DS0 (64 kb/s), DS0A (2.4, 4.8, 9.6, 19.2, and 56 kb/s), and DS0B (2.4, 4.8, and 9.6 kb/s) data rates over all DDS circuits.
30481	ML10633	DS0	DDS DS0/DS0A Data Interface — Meets Bellcore and AT&T requirements for DDS testing at DS0 (64 kb/s) and DS0A (2.4, 4.8, 9.6, and 56 kb/s) data rates.
41440	ML11668	T1/FT1	T1/FT1 Data Interface — Meets AT&T, Bellcore, and CCITT specifications for T1 (DS1) 1.544 Mb/s and fractional T1. Supports Performance Report Messages (PRMs) with Option 6009 installed.
40540	ML11035	DS1/T1	DS1/T1/D4/ESF/SLC-96 Data Interface — Meets AT&T, Bellcore, and CCITT specifications for T1 (DS1), AT&T PUB54016 specifications for Extended Superframe (ESF), and AT&T specifications for Subscriber Loop Carrier (SLC) circuits.
30447A	ML10980	DS1C/2	DS1C/DS2 Data Interface — Meets AT&T and Bellcore DSX-1C, DSX-2, or DS2H interface specifications for testing data communications systems operating at DS1C (3152 kb/s) and DS2 (6312 kb/s) data rates.
41945	ML12029	DS3	DS3 Data Interface — Complies with CB119, applicable sections of CCITT Recommendation G.703 for 44.736 Mb/s, and ANSI T1.102.
—	ML10607	INT232	Internal RS-232-C Data Interface — Meets EIA RS-232-C specification for testing synchronous and asynchronous circuits, to 64 kb/s and 20 kb/s, respectively. This interface is built into the FIREBERD 6000 mainframe.
40202	ML11031	V.35	V.35/306 DTE/DCE Data Interface — Meets CCITT V.35 Recommendation and AT&T PUB41304 for 306-type wideband data sets and PUB41450 for DDS Data Service Unit (DSU) specifications.
40200	ML11032	RS-449	RS-449 (422/423) DTE/DCE Data Interface — Meets EIA RS-449, EIA RS-422, and EIA RS-423 standards and CCITT Recommendations V.10 and V.11. This interface offers 3 modes of operation: RS-423/V.10 (unbalanced), RS-422/V.11 (balanced) terminated, and RS-422/V.11 (balanced) unterminated.
41400	ML11623	RS-449/MIL	RS-449/MIL Data Interface — Meets EIA RS-449/RS-530/RS-422/RS-MIL 423, MIL-STD-188-114, and MIL-STD-188C specifications. This interface can be configured as a DTE or a DCE device through the interface set-up menu. A crossover cable is not required.

## FIREBERD 6000 Data Interfaces (Continued)

<u>Model Number:</u>	<u>Manual Number:</u>	<u>Interface Label:</u>	<u>Description:</u>
42522	ML12569	449/V35	Combined Data Interface — Supports DCE and DTE operating modes for RS-449, V.35, 306, and X.21, relevant loopbacks, along with applicable specifications.
42219	ML12504	HSSI	High Speed Serial Interface — Complies with design specifications of cisco Systems, Inc. and T3 Plus Networking, Inc. Supports DCE operating mode with all specified loopbacks up to 52 Mb/s.
40226	ML11267	MILUNB	MIL188C/MIL118-114 Unbalanced Data Interface — Meets MIL-STD-118-114 bipolar unbalanced and MIL-STD-188C specifications.
40298	ML10511	MILBAL	MIL188-114 Balanced Data Interface — Meets MIL-STD-118-114 bipolar balanced specifications.
40182	ML11038	WEC303	WECO 303 Data Interface — Meets AT&T PUB41302 specifications for testing 303-type wideband data stations.
41910	ML11924	ACCESS	Test Access Interface — When used with a T1 or E1 data interface provides the functions of a switch, allowing the span to be sectionalized or tested from end to end.
41075	ML11256	ISDN	ISDN S/T TE Data Interface — Meets ANSI and CCITT standards for the ISDN S and T reference points.
40204	ML11037	LAB	LAB (TTL) Data Interface — Tests a variety of data handling devices, with BNC connections for received data and clock inputs, transmit data and clock outputs, and an external transmit clock input operating from 50 Hz to 15 MHz, with bipolar or unipolar balanced or unbalanced data. This interface can also control the clock and data phasing and match a variety of input and output impedances.
42242	ML12432	DTE IF	Diphase Data Interface — Meets TT-B1-1208-0130 specification for manchester diphase or conditioned diphase over extremely long cable runs at data rates from 1.2 kb/s to 4.608 Mb/s.

The following procedure describes the steps for installing an optional interface module in a FIREBERD 6000. Refer to Figure 1-3 for the interface slot location.

**CAUTION****TURN THE MAINFRAME POWER OFF BEFORE INSTALLING THE INTERFACE MODULE IN THE FIREBERD.**

1. Ensure that the **POWER** switch, on the FIREBERD front panel, is in the OFF position.
2. Turn the FIREBERD 6000 around to expose the vacant rear panel interface slot.
3. Insert the interface module into the vacant interface slot, with the printed circuit (PC) board facing up. The PC board edges fit into slides on either side at the top edges of the interface slot.

4. Press the interface module firmly into the mainframe mating connector, until the back of the interface faceplate is flush with the mainframe rear panel.
5. Secure the interface module in the mainframe by turning the two thumbscrews on the interface front panel clockwise, until finger tight.

This completes the interface installation procedure. The installed interface can be selected from the front panel by pressing the **MENU** switch to illuminate the LED next to the INTF SETUP label and then pressing the softkey below the installed interface label. Refer to Section 4 of this manual or the interface operating manual on how to remotely select the installed interface.

### **Interface Installation with an ISU**

Using the FIREBERD 6000 with an ISU (Interface Switching Unit) allows multiple interfaces to be installed in the ISU and selected one at a time. Up to four interfaces can be installed in an ISU and selected from the FIREBERD front panel or remotely by using a remote controller. Refer to Section 4 for a description of remotely controlling the FIREBERD.

The following procedure describes the steps required to select an interface that is installed in an ISU.

1. Ensure that the **POWER** switch, on the FIREBERD front panel, is in the OFF position.
2. Turn the FIREBERD 6000 around to expose the vacant rear panel interface slot.
3. Insert the Cable Interface Adaptor module into the vacant interface slot, with the printed circuit (PC) board facing up. The PC board edges fit into slides on either side at the top edges of the interface slot.
4. Press the Cable Interface Adaptor module firmly into the mainframe mating connector, until the back of the adaptor faceplate is flush with the mainframe rear panel.
5. Secure the adaptor module in the mainframe by turning the two thumbscrews on the interface front panel clockwise, until finger tight.
6. Install and secure the interface(s) in the ISU slot(s).
7. Turn the FIREBERD and ISU power on.

### **5.3.2 PR-40A Printer**

The PR-40A is an alphanumeric and graphics printer utilizing thermal dot matrix printing. The PR-40A features 40- and 80-column printing in a self-contained housing including complete control and interface electronics. It also provides bit-mapped histograms and jitter graphics. It can be powered by a built-in nickel cadmium battery or through an AC adaptor. This compact and portable printer connects to the RS-232 Printer/Controller Interface through a male-to-male printer cable.

For more information on the PR-40A printer, see the *PR-40A Operating Manual*.

### **5.3.3 PR-2000 Thermal Printer**

The PR-2000 is a non-impact alphanumeric thermal printer. It is capable of printing the full ASCII character set with up to 20 characters per line. The characters are input in a serial asynchronous format with start, stop, and parity bits. The printer may be rack-mounted along with the FIREBERD in the RM-6000 or RM-MC 6000 Rack Mount units. A cable is included with each printer, allowing direct interface with the FIREBERD RS-232 Printer/Controller Interface at 2400 baud.

For more information on the PR-2000 printer, see the *PR-2000 Operating Manual*.



## **Options and Accessories**

### **5.3.4 ISU Flush Door Accessory (Model 10518)**

The Interface Switching Unit can be equipped with an optional Flush Door Accessory. The accessory recesses the ISU panel approximately 4 1/2" behind the rack mount surface and provides a smoke gray plexiglass door. The unit conceals the interface modules and cables while still allowing access to the interface module front panels.

### **5.3.5 Interface Extender (Model 10770)**

The Interface Extender is an accessory to all FIREBERD mainframes housed in a metal case. The Interface Extender, which allows front panel access to the data interface module and its controls, connects to the FIREBERD via a shielded ribbon cable attached to a special data interface (included). The Model 10770 Interface Extender mounts under the FIREBERD mainframe. A Rack Mount Adaptor (Model 10773) is available for mounting the Interface Extender in a standard 19" rack.

### **5.3.6 FIREBERD 6000/6000R Rack Mount (Model RM-6000)**

The RM-6000 allows the standard FIREBERD 6000 (plastic case) or the FIREBERD 6000R and the PR-2000 thermal printer to be mounted in a standard 19" equipment rack. The assembly requires 7" of vertical rack space. The Rack Mount provides a power switch for the thermal printer and an AC receptacle to provide AC power to both the FIREBERD and the PR-2000 thermal printer.

#### **WARNING**

**TO MINIMIZE SHOCK HAZARD, THE RACK MOUNT CHASSIS MUST BE CONNECTED TO AN ELECTRICAL GROUND. THE RACK MOUNT IS EQUIPPED WITH A THREE-CONDUCTOR AC POWER CABLE. THE POWER CABLE MUST EITHER BE PLUGGED INTO AN APPROVED THREE-CONTACT ELECTRICAL OUTLET OR USED WITH A THREE-CONTACT TO TWO-CONTACT ADAPTOR WITH GROUNDING WIRE (GREEN) FIRMLY CONNECTED TO AN ELECTRICAL GROUND (SAFETY GROUND) AT THE POWER OUTLET.**

The following sections provide instructions for mounting the FIREBERD and the PR-2000 printer in the RM-6000 Rack Mount. If the FIREBERD has a swing-around handle, it must be removed before mounting into the Rack Mount; the user may either return the FIREBERD to TTC for handle removal or use the following handle removal instructions. If the FIREBERD does not have a handle, proceed directly to the assembly instructions.

#### **FIREBERD Handle Removal (All Metal, Black Side Arms and Cross Bar)**

1. Disconnect the AC power cord from the FIREBERD.
2. Remove the left and right push button and spring on each side (insert small screwdriver and pry gently). Remove the screw and washer from both sides. This will allow complete removal of handle and ratchet mechanism. The FIREBERD is now ready for rack mount assembly.

#### **Assembly Instructions**

1. Install the printer as follows: \*
  - a) Insert the PR-2000 through the Rack Mount Panel from the front.
  - b) Unlatch and slide the printer mechanism forward, exposing the printer mounting ears. Install four #4-40 x 3/16" pan head screws into the holes of the mounting ears, then return the printer mechanism to its operating position (closed).
  - c) Install the printer support bracket at the rear of the printer by removing the two #3 screws at the top rear of the PR-2000. Attach the support bracket to the printer and chassis using four #4-40 x 3/16" screws and lock washers.

\* If a printer is not to be installed into the Rack Mount unit, a blank plate is available to cover the Printer Mounting hole.

2. Install FIREBERD as follows:
  - a) Make sure the FIREBERD does not have the handle or side handle ratchet installed. The sides of the FIREBERD must be free of all handle components so that it will fit into the rack adaptor.
  - b) Place the FIREBERD on the shelf, front panel facing forward, and carefully manipulate the front of the case through the opening. It should protrude through the front panel about 1/4 inch.
  - c) Lift the rear of the FIREBERD and insert the two 1/4" x 3/16" hex standoffs in the rear feet and align with two holes in the shelf. Install two #6-40 x 3/16" screws and two lock washers through the bottom of the shelf into the standoffs.
  - d) Install the two "Z" hold-down brackets at the rear of the instrument using the #4 hardware provided with the rack adaptor.
  - e) Plug the FIREBERD and the printer into the 115 VAC receptacle. The printer should be plugged into the receptacle that is controlled by the front-panel switch.
  - f) Fold and store the excess FIREBERD and printer line cords under the printer. The bracket is designed to allow cable storage.
3. Connect the cable supplied with the printer from the 25-pin, D-type connector on the rear of the printer to the RS-232 printer connector on the FIREBERD.
4. The RM-6000 unit is now be ready for rack installation. The unit mounts in a rack by its front panel without further angle brackets or supports.

### **5.3.7 FIREBERD MC6000 Rack Mount (Model RM-MC)**

The RM-MC allows the FIREBERD MC6000 and the PR-2000 thermal printer to be mounted in a standard 19" equipment rack. This assembly requires 7" of vertical rack space. The Rack Mount provides a power switch for the Thermal Printer and an AC receptacle to provide AC power to both the FIREBERD and the PR-2000 thermal printer.

#### **WARNING**

**TO MINIMIZE SHOCK HAZARD, THE RACK MOUNT CHASSIS MUST BE CONNECTED TO AN ELECTRICAL GROUND. THE RACK MOUNT IS EQUIPPED WITH A THREE-CONDUCTOR AC POWER CABLE. THE POWER CABLE MUST EITHER BE PLUGGED INTO AN APPROVED THREE-CONTACT ELECTRICAL OUTLET OR USED WITH A THREE CONTACT OR TWO CONTACT ADAPTOR WITH GROUNDING WIRE (GREEN) FIRMLY CONNECTED TO AN ELECTRICAL GROUND (SAFETY GROUND) AT THE POWER OUTLET.**

The following sections provide instructions for mounting the FIREBERD and the PR-2000 printer in the RM-MC Rack Mount. If the FIREBERD has a swing-around handle, this handle must be removed before mounting into the Rack Mount, the user may either return the FIREBERD to TTC for handle removal or use the following handle removal instructions. If the FIREBERD does not have a handle, proceed directly to the assembly instructions.

#### **FIREBERD Handle Removal (Metal Case Units)**

1. Disconnect the AC power cord from the FIREBERD.
2. Remove the left and right push button and spring on each side (insert small screw driver and pry gently). Remove the screw and washer from both sides. This will allow complete removal of handle and ratchet mechanism. The FIREBERD is now ready for rack mount assembly.

### Assembly Instructions

1. Install the printer as follows\*:
  - a) Insert the PR-2000 through the Rack Mount Panel from the front.
  - b) Unlatch and slide the printer mechanism forward, exposing the printer mounting ears. Install four #4-40 x 3/16" pan head screws into the holes of the mounting ears then return the printer mechanism to its operating position (closed).
2. Install FIREBERD as follows:
  - a) Make sure that the FIREBERD does not have the handle installed. The sides of the FIREBERD must be free of all handle components in order to fit into the rack adaptor.
  - b) Place the FIREBERD on the shelf, front panel facing forward, and carefully manipulate the front of the case through the opening. It should protrude through the front panel until the lip of the bezel fits solidly.
  - c) Install the two "Z" hold-down brackets at the rear of the instrument using the #4 hardware provided with the rack adaptor.
  - d) Plug the FIREBERD and the printer into the AC receptacle. The printer should be plugged into the receptacle that is controlled by the front panel switch.
  - e) Fold and store the excess FIREBERD and printer line cords under the printer.
3. Connect the cable supplied with the printer from the 25-pin, D-type connector on the rear of the printer to the RS-232 printer connector on the FIREBERD.
4. The RM-MC6000 unit is now ready for rack installation. The unit mounts in a rack by its front panel without further angle brackets or supports.

\*If a printer is not to be installed into the Rack Mount unit, a blank plate is available to cover the Printer Mounting hole.

#### 5.3.8 Hard Shipping Case (Model 40527)

The rigid ABS molded case has a foam-padded interior with cavities to hold the FIREBERD MC6000 and its accessories. The case is rugged and water-resistant, and has stainless steel draw latches and a molded handle.

#### 5.3.9 Soft Carrying Case (Model 41169)

The FIREBERD Soft Carrying Case is constructed of canvas with dense foam inserts surrounding all sides, top, and bottom. The dimensions are 19 1/2" wide x 9 1/2" deep x 16 1/8" high. The case is navy blue and has an I.D. pocket on the top cover. The top cover is hinged and secured with Velcro fasteners. The case is carried by a handle that supports across the bottom and up both sides. Additionally, there is a padded, adjustable, snap-on shoulder strap.

The carrying case holds one standard FIREBERD (plastic case), a PR-2000 thermal printer, one manual, and three interface modules in addition to the associated cables and line cords. The carrying case will also hold one FIREBERD MC6000 (metal case), one manual, two interface modules, and several cables. Empty, the case weighs 6 1/4 lbs.

### 5.3.10 PR-85 Soft Carrying Case

The PR-85 Soft Carrying Case is constructed of canvas with dense foam inserts surrounding all sides, top, and bottom. The dimensions of the case are 20" wide x 8 1/2" deep x 17 1/2" high. The top cover is hinged and secured with Velcro fasteners. The case is carried by a handle that supports the bottom and both sides of the case. The carrying case includes a backpouch used to hold the operating manual, printer paper, and printer cable. Empty, the case weighs 3 1/4 pounds.

### 5.3.11 ISU-6000 Interface Switching Unit

The ISU-6000 Interface Switching Unit (ISU) is a rack-mountable product capable of accommodating multiple data interface modules and electronically setting one interface for use with the FIREBERD 6000. Using this device, the user can operate a FIREBERD 6000 without handling interfaces or moving cables. Switching between the installed interfaces is controlled by the FIREBERD 6000 Interface Setup menu.

#### Single-Unit Configuration (Four Interfaces)

The ISU-6000 may be configured to accommodate four or eight interfaces. The components for each configuration are listed as follows:

- One Interface Shelf (Model 10805).
- One Single Cable Interface Adaptor (Model 40678).
- One Flush Door (Model 10518) (optional).

#### Dual-Unit Configuration (Eight Interfaces)

- Two Interface Shelves (Model 10805).
- One Dual Cable Interface Adaptor (Model 40681).
- Two Flush Doors (Model 10518) (optional).

## 5.4 ORDERING INFORMATION

The following is a list of accessories available from TTC at the time this manual was printed; model numbers are listed for ordering purposes. Contact TTC for an up-to-date list.

### **RACK MOUNTS**

Rack Mount for FIREBERD 6000 (Plastic Case) and printer	RM-6000
Rack Mount for FIREBERD MC6000 and Printer	RM-MC6000
Rack Mount for FIREBERD 6000R	RM-6000

### **INTERFACE SWITCHING UNITS (ISU)**

Interface Switching Unit (4 Interfaces)	ISU 6000-4
Interface Switching Unit (8 Interfaces)	ISU 6000-8
Interface Switching Unit Flush Door	10518
Interface Extender (for FIREBERD metal case)	10770
Rack Mount Adaptor for Interface Extender	10773

## Options and Accessories

### PRINTERS

PR-2000 Thermal Printer (20-column) with cable	PR-2000
PR-2000 Printer Paper (12 rolls)	10217
PR40A Thermal Graphics Printer	PR40A
PR40A Thermal Printer Paper (10 rolls)	10966
PR-85 ASCII and Graphics Printer (80-column) with cable	PR-85
PR-85 Soft Carrying Case	40522
PR-85 Printer Paper (2400 sheets)	10651
PR-85 Printer Replacement Ribbon	10653
PR-85 Printer Replacement Print Head	10671

### MISCELLANEOUS

Replacement Operating Manual Set	ML12120
Replacement Telephone Handset with 12' cord	11255
Soft Carrying Case (for both FIREBERD plastic and metal case)	41169
Hard Shipping Case (for both FIREBERD plastic and metal case)	40572
Remote Adaptor (For RS-232 and IEEE-488 Remote Control)	30379
Transmit Line Build Out	10557
440A to BNC Adaptor Plug	10830
358 to BNC Adaptor Plug	10831

### DATA INTERFACE MODULES

CCITT G.703 2048 kb/s Data Interface	40380
CCITT G.702 64 kb/s Codirectional Data Interface	40323
CCITT G.703 64 kb/s Data Interface	30608
CCITT G.703 8448 kb/s Data Interface	30524
CCITT G.704 2048 kb/s Data Interface	30609
2M/n64 kb/s Data Interface	41800
DDS Local Loop Interface	41131

### DATA INTERFACE MODULES

DDS DS0A/DS0B Data Interface	30678
DDS DS0/DS0A Data Interface	30481
T1/FT1 Data Interface	41440
DS1/T1/D4/ESF/SLC-96 Data Interface	40540
DS1/T1/D4 Data Interface	40405
DS1/T1 Data Interface (Unframed Only)	40365
DS1C/D2 Data Interface	30447A
DS3 Data Interface	41945
HSSI Data Interface	42219
ISDN S/T TE Data Interface	41075
LAB (TTL) Data Interface	40204
Access Data Interface	41910
Diphase Data Interface	42242
MIL188-114 Balanced Data Interface	40298
MIL188C/MIL118-114 Unbalanced Data Interface	40226
RS-232/V.24/MIL188C DTE/DCE Data Interface	40392
RS-232 Synchronous DTE/DCE Data Interface	40236
RS-232 Synchronous/Isochronous DTE Data Interface	40232
RS-449/MIL Data Interface	41400
RS-449 (422/423) DTE/DCE Data Interface	40200
RS449/V.35/306/X.21 Data Interface	42522
V.35/306 DTE/DCE Data Interface	40202
WECO 303 Data Interface	40182

**CABLES**

RS-232/V.24 male-to-male cable (6')	10213
RS-232/V.24 male-to-male cable (10')	10418
V.35/306 male-to-male cable (6')	10214
V.35/306 male-to-male cable (10')	10419
RS-449/Military male-to-male cable (6')	10215
RS-449/Military male-to-male cable (10')	10417
WECO 310 plug to WECO 310 plug cable (10')	10420
WECO 310 plug to alligator clips cable (10')	10558
WECO 310 plug to bantam plug cable (4')	10599
WECO 310 plug to bantam plug cable (10')	10559
Dual bantam plug to 15-pin adaptor cable (10')	30503
Military male 37-pin D to male 25-pin D adaptor cable (6')	10496
Military male 37-pin D to female 25-pin D adaptor cable (6')	10538
RS-449 DTE to X.21 DTE adaptor cable	10562
OIU adaptor cable, 9-pin, male-to-male	20309
Lenkurt/Siemens Panel Jack to Dual Bantam 9-pin male (20')	41515
Bantam plug to bantam plug cable	10615
Bantam plug to alligator clips (10')	10648
Bantam plug to 5-pin male, Wescom adaptor (14")	30518
Bantam plug (dual) to RJ45S (10')	40602
Bantam plug (dual) to RJ45C (10')	40601
RJ45 to RJ45 cable (14')	11266
RJ45 to alligator clips (10')	30837
Siemens 3-pin to Siemens 3-pin (6')	30687
Siemens 3-pin to bantam plug (6')	30761
HSSI 50-pin D male-to-male cable (10')	42417
440A to 440A cable (10')	30598-01
440A to 440A cable (1')	30598-02
440A to 358 adaptor cable (10')	30599-01
V.35/306 female to dual male Y cable (2')	43013-01

**BREAKOUT BOXES**

Breakout Box for RS-232C, V.24/V.28, MIL-188C	Model 25
Breakout Box for V.35, Bell 306	Model 34
Breakout Box for RS-449, V.10/V.11, MIL-188-114	Model 37







## APPENDIX A MAINTENANCE AND SERVICE

### A.1 SECTION SUMMARY

This section contains information on maintenance and service for the FIREBERD 6000. Specifically, it includes steps to take should the user experience difficulty operating the FIREBERD, maintenance procedures for the fan screen, and a description of TTC's warranty and repair procedures.

### A.2 MAINTENANCE

#### A.2.1 In Case of Difficulty

If the unit fails to operate and no front or rear panel indicators illuminate, check the following:

- AC power cord and AC supply
- AC fuse and fuse size

If some indicators light but the unit fails to operate with an optional interface installed, there are three checks that can be made: (1) determine whether the interface in use is the correct one for the desired application; (2) verify that the interface is properly inserted in the interface slot; or (3) insert another interface (suitable for the application) in the event that the original interface is not operating properly. Power to the FIREBERD should always be off before removing or inserting interface modules. The interface cable and connections to the FIREBERD should also be checked.

Follow the Self-Test Procedure in Section 1 as an aid in localizing the problem. If the unit cannot be made to operate properly, call the TTC Customer Service Department for applications assistance.

#### A.2.2 Fan Screen

A fan mounted on the rear panel of the FIREBERD allows proper cooling and ventilation of the internal components. The fan is always in operation while the FIREBERD is on; the fan cannot be operated independently. The fan is protected by a screen which is attached to the outside of the rear panel for easy maintenance. The screen should be checked and cleaned periodically to ensure proper cooling operation. Before removing the screen for cleaning, remove power to the FIREBERD and allow the fan to stop. Remove the four screws which attach the screen to the rear panel. The screen may be cleaned with compressed air or, if necessary, with a cleaning solvent. Reattach the screen by replacing the four screws which hold it in place.

### A.3 SERVICE

#### A.3.1 Warranty Policy

All equipment manufactured by Telecommunications Techniques Corporation (TTC) is warranted against defects in material and workmanship. This warranty applies only to the original purchaser and is non-transferable unless express written authorization of the warranty transfer is granted by TTC.

FIREBERD mainframes (Models 6000, 6000A, MC6000, 6000R) will be repaired or replaced (at our option) at no charge for a period of 3 years after shipment to the customer. Data interfaces, cables, breakout boxes, accessories, and all equipment other than FIREBERD mainframes will be repaired or replaced (at our option) at no charge for a period of 1 year after shipment to the customer.

## **Maintenance And Service**

Liability under this warranty extends only to the replacement value of the equipment. This warranty is void under the following conditions:

1. Equipment has been altered or repaired without specific authorization by TTC.
2. Equipment is installed or operated other than in accordance with instructions contained in TTC literature and operating manuals.

No other warranty is expressed or implied. TTC is not liable for consequential damages.

### **A.3.2 In-Warranty Service**

In-warranty equipment must be returned to the factory with shipping prepaid. The equipment should be packed and shipped in accordance with the instructions contained in Section A.3.5 of this manual. Defective units will be repaired or replaced (at our option) depending on severity of defect. Before returning any equipment, the customer must obtain a Return Authorization (RA) number by contacting the TTC Customer Service Department. The RA number should then appear on all paperwork and be clearly marked on the outside of the equipment container.

After the equipment is repaired by TTC, it will be tested to applicable specifications, burned-in for at least 24 hours, retested, and returned to the customer with shipping prepaid. A brief description of the work performed and the materials used will be provided on the Equipment Repair Report furnished with the returned equipment.

### **A.3.3 Out-of-Warranty Service**

The procedure for repairing out-of-warranty equipment is the same as that used for equipment still in warranty. However, there is a minimum charge applied to each request for out-of-warranty service. The minimum charge guarantees the customer an estimate of the repair costs and is used as credit against actual materials and labor costs should the equipment be repaired. Contact the TTC Repair Department for specific information on the minimum out-of-warranty repair charge.

The customer will be billed for parts plus standard labor rates in effect at the time of repair. The customer will also be required to furnish a purchase order number before repair work can be started, and a hard copy of the purchase order must be received by TTC before the repaired equipment may be shipped to the customer. A description of the labor and materials used will be provided in the Equipment Repair Report.

### **A.3.4 Recommended Equipment Calibration**

TTC recommends a 1 year calibration interval for the FIREBERD 6000 mainframe to ensure conformance to specified accuracy, range, resolution, and stability.

### **A.3.5 Equipment Return Instructions**

To all equipment returned for repair, the customer should attach a tag that includes the following information.

1. Owner's name and address.
2. A list of the equipment being returned and the applicable serial number(s).
3. A detailed description of the problem or service requested.
4. The name and telephone number of the person to contact regarding questions about the repair.
5. The Return Authorization (RA) number.

If a FIREBERD mainframe is being returned, it is recommended that all switches be left in the positions they were in when the problem occurred. The interface module in use at the time of the failure should also be returned.

If possible, the customer should return the equipment using the original shipping container and material. If the original container is not available, the unit should be carefully packed so that it will not be damaged in transit. TTC is not liable for any damage that may occur during shipping. The customer should clearly mark the TTC-issued RA number on the outside of the package and ship it prepaid and insured to TTC.



## APPENDIX B JITTER OPTIONS

### B.1 SECTION SUMMARY

Section B offers information on the jitter options available with the FIREBERD 6000. The first half of the section describes DS1 Jitter; the second half describes G.703/G.704 Jitter.

### B.2 DS1 JITTER GENERATION AND MEASUREMENT

Jitter on a digital line is the displacement in time of a data pulse from its ideal position. Two parameters are used to characterize jitter. The first is the amplitude of the phase displacement, which varies over time. The amplitude is measured in unit intervals (UI), where one UI is equal to the amount of time associated with one T1 bit period, or 648 nanoseconds at 1544 kb/s. The second parameter is the frequency at which the amplitude is changing measured in Hertz (Hz).

The FIREBERD 6000 offers the following options for testing jitter:

- DS1 Wideband Jitter Measurement (Option 6001)
- DS1 Jitter Spectral Analysis (Option 6002)
- DS1 Jitter Generation (Option 6003)

The DS1 Wideband Jitter Measurement option measures jitter over a wide frequency band (10 Hz to 40 kHz). This measurement follows the guidelines set forth in CCITT Recommendation O.171. The DS1 Jitter Spectral Analysis option performs a 40-band spectrum analysis on the wideband jitter; the DS1 Wideband Jitter Measurement option must be installed to use the Spectral Analysis option. The DS1 Jitter Generator option can apply a sine, square, ramp, triangle, and/or an externally supplied waveform jitter signal to an internal, external, or recovered T1 clock signal.

Each option may be used with the DS1/D4/Fe Data Interface (Model 40460), DS1/T1 Data Interface (Model 40540), or the T1/FT1 Data Interface (Model 41440). All three operate simultaneously.

#### B.2.1 DS1 Wideband Jitter Measurement Option

The DS1 Wideband Jitter Measurement option receives a jittered clock signal from either the DS1/D4/Fe Data Interface, the DS1/T1 Data Interface, or the T1/FT1 Data Interface. The Wideband Jitter option then demodulates the jittered clock and makes the following measurements.

- Peak-to-peak jitter (1SEC JTR)
- Maximum peak-to-peak jitter (MAX JTR)
- Jitter hits count (JTR HITS)

## **Jitter Options**

### **Functional Description**

The DS1 Wideband Jitter Measurement option demodulates the jittered clock by generating a voltage that is proportional in amplitude to that of the phase displacement. This full bandwidth jitter voltage is sent to two places:

1. The measurement circuits on the Wideband Jitter option.
2. The DS1 Jitter Spectral Analysis option for further analysis.

After the demodulated jitter signal is sent to the DS1 Jitter Spectral Analysis option, an 8 kHz high-pass filter may be selected, if desired. This filter allows only the high frequency components to be measured. The jitter signal, either with or without the filter, is buffered and sent to the BNC connector labeled DEMOD JITTER OUT. The jitter voltage is measured using a peak-to-peak measurement circuit.

The Wideband Jitter option also measures jitter hits. A jitter hit occurs when the jitter exceeds a user-selectable threshold. It is the absolute value of the demodulated jitter that is measured; thus, both positive and negative jitter peaks are compared to the peak jitter threshold.

### **Operation**

Figure B-1 shows the T1 jitter menu tree, accessed by setting the **MENU** switch to the JITTER position. The DS1 Wideband Jitter Measurement modes are accessed via two softkeys: HITS and FILTER.

The HITS softkey allows the user to specify a peak jitter threshold within the range 0.1 - 6.5 UIs. The peak jitter threshold may be entered via the keypad by typing two digits and pressing **ENTER**; the UP and DOWN softkeys can also be used to respectively raise or lower the peak jitter threshold by 0.1 UI each time the respective softkey is pressed.

The FILTER softkey controls the high-pass filter. When it is pressed, the FULL and >8 kHz selections appear in the display. Pressing the FULL softkey causes the high-pass filter to be removed from the jitter measurement path. Pressing the >8 kHz softkey causes the high-pass filter to be inserted in the jitter measurement path.

The LIST softkey sends a list of the jitter spectral analyzer frequency band measurements and their corresponding %MASK values to the selected printer. If the jitter spectrum analyzer sweep is turned off, only one frequency in the list is printed; the others remain blank.

The GRAPH softkey generates a graph of the DS1 Jitter Spectral Analysis results. The graphics are Epson-compatible and can be used with TTC's PR-85 or PR-40A Printer. The results are graphed only when the jitter spectrum analyzer sweep is on.

The jitter results - 1 SEC JTR, MAX JTR, and JTR HITS - are found in the SIGNAL category of results. The 1SEC JTR result is the maximum jitter measured over the last second. The MAX JTR result is the maximum of the 1SEC JTR results since the last test restart. If the DS1 Wideband Jitter Measurement option is not installed, these results are not available.

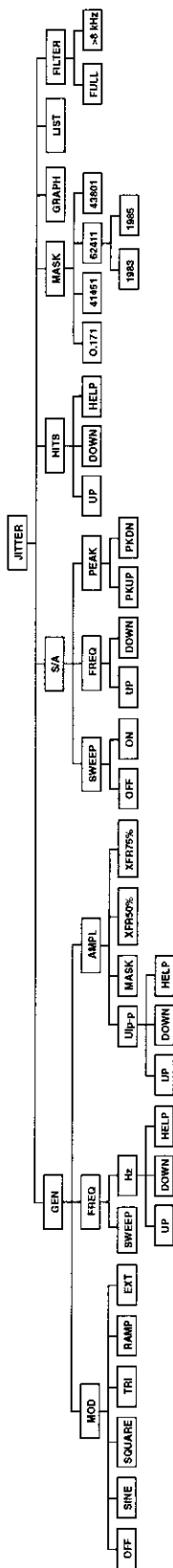

Figure B-1  
Jitter Menu Tree

## Jitter Options

### Specifications

Data Rate:	<ul style="list-style-type: none"><li>• 1544 kb/s.</li></ul>
Bandwidth:	<ul style="list-style-type: none"><li>• -20 dB/decade below -3 dB point at 2 Hz.</li><li>• -120 dB/decade above -3 dB point at 68 kHz.</li></ul>
Selectable High Pass Filter:	<ul style="list-style-type: none"><li>• -20 dB/decade below -3 dB point at 8 kHz.</li></ul>
Measurement Accuracy:	<ul style="list-style-type: none"><li>• TERM with 0-20 dB resistive attenuation.</li></ul>
Measurement Accuracy:	<ul style="list-style-type: none"><li>• DSX-MON with 0 to 30 dB resistive attenuation. ±5% ±.04 UI within the range 10 Hz to 1 kHz. ±7% ±.04 UI within the range 1 kHz to 10 kHz. ±10% ±.06 UI within the range 10 kHz to 40 kHz.</li><li>• BRIDGE with 0 to 24 dB cable attenuation. ±7% ±0.3 UI within the range 10 Hz to 40 kHz.</li></ul>
Range:	<ul style="list-style-type: none"><li>• 0 to 13.00 UI peak-to-peak.</li></ul>
Resolution:	<ul style="list-style-type: none"><li>• 0.01 UI.</li></ul>
Jitter Hit Threshold:	<ul style="list-style-type: none"><li>• Maximum — 6.5 UI.</li><li>• Resolution — 0.1 UI.</li></ul>
JITTER OUT BNC:	<ul style="list-style-type: none"><li>• Scale — 0.1 V/UI.</li><li>• Range — 0-1.3V peak-to-peak.</li><li>• Drive Capability — 50 ohms minimum termination.</li></ul>

### **B.2.2 DS1 Jitter Spectral Analysis Option**

The DS1 Jitter Spectral Analysis option consists of a printed circuit board that plugs into the Wideband Jitter option. The spectrum analyzer measures the maximum peak-to-peak jitter in 40 frequency bands from 10 Hz to 40 kHz and displays the result in unit intervals (UIs) peak-to-peak. This option measures:

- Jitter amplitude in UI peak-to-peak with a continuous sweep of 40 frequency bands.
- Continuous jitter amplitude in UI peak-to-peak in 1 of 40 frequency bands.
- Percent of tolerance specification mask for each band.

### Functional Description

The DS1 Jitter Spectral Analysis option allows the user to determine the spectral content of jitter in a T1 system. This is accomplished by filtering the wideband jitter signal obtained from the DS1 Wideband Jitter option into 40 discrete frequency bands. The output of each filter is then measured using a peak-to-peak measurement circuit. The Spectral Analysis option can either:

1. Continuously measure 1 of the 40 available frequency bands and constantly update the jitter amplitude for that frequency.
2. Continuously sweep through all 40 frequency bands. When the sweep is enabled, each jitter value stored in the 40 frequency bands is compared to the measured value of the corresponding frequency; the maximum value is saved until a test restart occurs.



The sweep function of the Spectral Analysis option operates synchronously with the sweep function of the DS1 Jitter Generation option. The jitter generator generates jitter at a specific frequency, the spectrum analyzer measures that frequency band, and both options increment to the next frequency band. This capability can be used to test equipment for bit errors or jitter attenuation characteristics. (See the Functional Description in Section B.3.3 for more information.)

The time required to complete one sweep of the spectrum analyzer depends on the jitter generator sweep. When the jitter generator sweep is turned off, it takes approximately 60 seconds to complete one sweep of the spectrum analyzer. When the jitter generator sweep is turned on, it takes approximately 90 seconds to complete one sweep.

Care should be exercised in comparing the spectral analysis results with the wideband jitter result discussed in Section B.3.1. The Wideband Jitter option makes continuous measurements over the entire 10 Hz to 40 kHz band. The result obtained with that option is a true indication of the maximum jitter over the entire band. This is in contrast to the spectrum analyzer which looks at a much narrower bandwidth for each measurement. In a normal system, jitter measured in the 40 spectrum analyzer bands are added in a complex and non-linear fashion. As a result, it is important that the wideband measurement be used in conjunction with the spectrum analyzer measurements in determining system performance.

### **Operation**

The DS1 Spectral Analysis measurement modes are accessed in the JITTER menu tree (see Figure B-1) by pressing the S/A softkey. At this level in the menu, the current frequency and the measured amplitude at that frequency are displayed. If the sweep is disabled, the frequency displayed is static, and the amplitude at that frequency is updated as each measurement is completed. If the sweep is enabled, the frequency displayed sweeps along with the measurement, which allows the user to know the status of the sweep at any point in time. In addition, the amplitude displayed for each frequency is the maximum amplitude measured in that band since the last test restart.

Pressing the SWEEP softkey causes the selections ON and OFF to be displayed; selecting either the ON or OFF softkey places the sweep function in the corresponding state. Pressing the FREQ softkey accesses the UP and DOWN softkey results which can be used to scroll through the 40 frequency bands. When the sweep is enabled, the amplitude displayed is the maximum value stored for that band. When the sweep is disabled, pressing either the UP or DOWN softkey changes the frequency band currently being measured to the band selected by the softkey.

When the PEAK softkey is pressed, the PEAKUP and PEAKDN softkeys allow the user to quickly find any peaks in the spectrum when the sweep is enabled. A peak is defined as those bands where the jitter is worst in relation to the selected jitter mask. The PEAKUP softkey finds the next higher frequency jitter peak and the PEAKDN softkey finds the next lower frequency jitter peak. Since there are no peaks when the sweep is disabled, the PEAK softkey is not visible if the sweep is off.

### **Spectral Analysis Results**

Two spectral analysis results are available in the FIREBERD 6000 SIGNAL category: S/A and %MASK.

The S/A results contain the frequency and the amplitude being measured by the spectrum analyzer. If the sweep is enabled, the frequency sweeps through the 40 bands, displaying the highest amplitude measured in each band. If the sweep is disabled, the frequency is displayed and the amplitude of that frequency is continually updated with each new measurement. The UP softkey increments the frequency; the DOWN softkey decrements the frequency.

The %MASK result compares the measured amplitude of a frequency band to the selected tolerance specification mask value of that frequency. This result indicates whether the jitter amplitude is within the limits specified for a given mask; for example, 110 % MASK is 10% above the allowable jitter level and 50 %MASK is half the allowable jitter level (see Section B.2.4). If the sweep is disabled, the %MASK corresponds to the frequency being measured. If the sweep is enabled, the %MASK corresponds to the largest %MASK of the 40 frequency bands. The 40 points can all be obtained through the printer or remote control with the jitter list command. (See Jitter Commands in Section 4 for this command).

**Jitter Options**

**Specifications**

- Data Rate: • 1544 kb/s.
- Frequency Points/  
Measurement Bandwidths: • See Table B-1.
- Filter Bandwidths: • Specified at the .1 dB and 3 dB points with 36 dB octave roll-off (see Table B-2 and Figure B-2).
- Accuracy: •  $\pm 10\%$  of reading  $\pm 0.05$  UI.
- Resolution: • 0.01 UI.
- Range: • 0.01 to 12.5 UI.

**Table B-1  
Frequency Point and Measurement Bandwidths**

10 Hz BW	33 Hz BW	100 Hz BW	333 Hz BW	1 kHz BW	3.3 kHz BW
10 Hz	100 Hz	300 Hz	1.00 kHz	3.00 kHz	10.0 kHz
20 Hz	133 Hz	400 Hz	1.33 kHz	4.00 kHz	13.3 kHz
30 Hz	166 Hz	500 Hz	1.66 kHz	5.00 kHz	16.6 kHz
40 Hz	200 Hz	600 Hz	2.00 kHz	6.00 kHz	20.0 kHz
50 Hz	233 Hz	700 Hz	2.33 kHz	7.00 kHz	23.3 kHz
60 Hz		800 Hz		8.00 kHz	26.6 kHz
70 Hz					30.0 kHz
80 Hz					33.3 kHz
					36.6 kHz
					40.0 kHz

**Table B-2  
Filter Bandwidths**

Nominal Bandwidth	Minimum .1 dB Bandwidth	Maximum 3dB Bandwidth
10 Hz	9.0 Hz	11.9 Hz
33 Hz	30.1 Hz	39.4 Hz
100 Hz	89.5 Hz	117 Hz
333 Hz	301 Hz	391 Hz
1 kHz	904 Hz	1.17 kHz
3.3 kHz	3.02 kHz	3.91 kHz

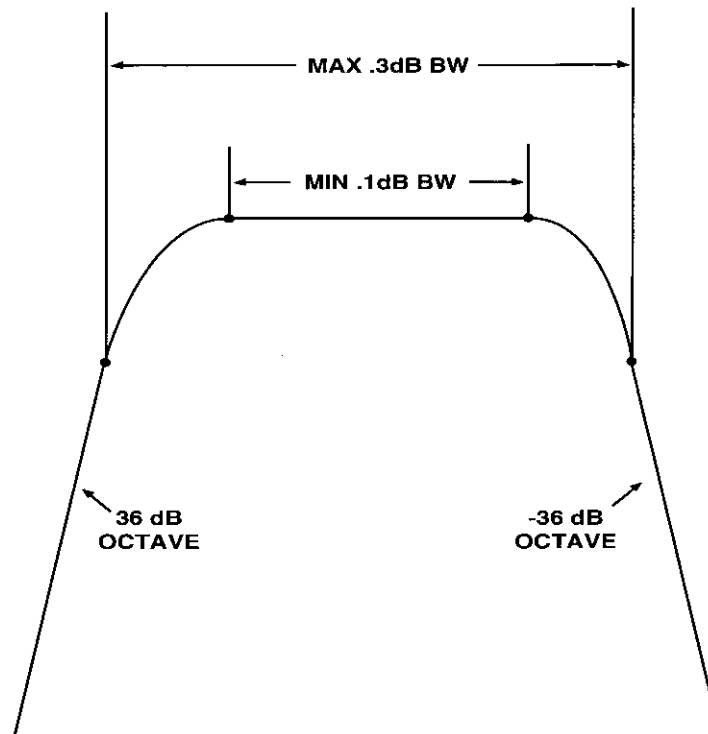

**Figure B-2**  
**Filter Bandwidths**

### **B.2.3 DS1 Jitter Generation Option**

The DS1 Jitter Generation option can phase modulate a T1 signal using an internally generated waveform, an external waveform, or a combination of both to produce T1 jitter. Jitter can be produced on an internal clock, external clock, recovered clock. The following list summarizes the features of the DS1 Jitter Generation option.

#### Frequency:

- User-selectable frequency, 3-digit resolution.
- Can automatically sweep the 10 Hz to 40 kHz band in 40 steps.

#### Amplitude:

- User-selectable amplitude, 0 to 13 UI peak-to-peak, .02 UI resolution.
- Can automatically set to selected mask level.
- Can automatically set to 50% or 75% of the selected mask level.

#### Modulation:

- Sine.
- Square.
- Triangle.
- Ramp.
- External.

#### Clock Sources:

- Internal.
- External.
- Recovered.

## **Jitter Options**

### **Functional Description**

The DS1 Jitter Generation option can apply jitter to a T1 signal by phase modulating the signal with another waveform. This waveform can be externally generated or internally generated by the jitter generator.

There are three clock sources which can be used with the jitter generator. Each can be selected via the **GEN CLK** switch.

1. Internal timing. When selected, a 1.544 MHz oscillator on the jitter generator is used. (The frequency synthesizer is used to generate the jitter modulation.)
2. The recovered clock, taken from the DS1/T1 Interface receive input.
3. An external clock source, applied to the BNC connector on the FIREBERD rear panel.

There are three parameters that are selected with the DS1 Jitter Generation option: modulation type, frequency, and amplitude.

In addition to external modulation, the jitter generator allows four types of internal modulation: sine, square, ramp, or triangle wave. When any one of these waveforms is selected, it is added to the external waveform. If desired, however, the external signal can be the only modulation signal used. If the modulation is turned off, the DS1 Jitter Generation option no longer supplies timing to the DS1/T1 Interface.

The modulation frequency can be selected with a 3-digit resolution from 10.0 Hz to 40.0 kHz. As an alternative to fixed-frequency jitter modulation, the FIREBERD can sweep through the same 40 points measured by the spectrum analyzer. In such instances, the instrument generates jitter at each frequency for approximately 1 second. If the spectral analyzer sweep is enabled, the jitter generator and the spectrum analyzer sweep in unison, with jitter generation and spectral measurements occurring simultaneously at each of the 40 points.

Whether or not the jitter generator sweep is enabled, jitter amplitude can be selected manually (UIp-p menu selection) or can be automatically referenced to the selected jitter mask (MASK menu selection). In either case, the range of the jitter amplitude is 0 UI to 13 UI peak-to-peak in .02 UI steps. When MASK is selected, the amplitude of the generated jitter is automatically set to the level specified by the selected mask for the current jitter frequency. MASK is used with the jitter sweep to perform jitter tolerance tests. The jitter generator amplitude can also be set to XFR50% or XFR75%, which sets the amplitude of the generated jitter to half or three-quarters of the jitter specified by the mask, respectively. These selections are used with the jitter sweep to test jitter transfer characteristics.

### **Operation**

Jitter generation functions are accessed through the JITTER menu tree (see Figure B-1). When pressed, the GEN softkey provides entry into the jitter generation menu; at the next level (MOD, FREQ, and AMPL softkeys), the frequency and amplitude displayed reflect the actual amount of jitter being generated. When a contention occurs, these actual amounts may differ from the values which the user has selected. A contention occurs when the amplitude selected is greater than the amplitude that can be generated at the selected frequency; a message is displayed to indicate the contention.

**NOTE:** At lower levels in the menu, the display always shows the frequency and amplitude values selected by the user, rather than the frequency and amplitude of the jitter actually being generated. Likewise, when a contention occurs at these lower menu levels, a message is displayed to indicate that a contention exists. To view the actual amount of jitter being generated, the user must return to the top level (GEN softkey) of the menu.

### **The MOD Softkey**

When pressed, the MOD softkey is used to select a modulation-type. If modulation is set to OFF, the generator clock is not modulated; if set to EXT, the external BNC connector (labeled JITTER MOD IN) is the modulation source; the SIN, SQU, TRI, and RAMP softkeys select, sine, square, triangle, or ramp waveforms, respectively. When SIN, SQU, TRI, and RAMP are selected, these waveforms are mixed with the BNC to provide the jitter waveform.

### **The FREQ Softkey**

The FREQ softkey is used to select a frequency. When pressed, two softkey choices are available: SWEEP and Hz.

The SWEEP softkey enables or disables the sweep function. When enabled, SWEEP is displayed instead of the current frequency.

The Hz softkey disables the sweep functions, and allows the desired frequency to be entered. When pressed, three softkey choices are available: UP, DOWN, and HELP.

The UP and DOWN softkeys step through the 40 frequencies corresponding to the spectrum analyzer's 40 bands, and the HELP softkey gives instructions for entering a new frequency from the keypad. The current jitter generator frequency is displayed and a new frequency can be entered and implemented using the MENU keypad and the **ENTER** key, respectively.

### **The AMPL Softkey**

The AMPL softkey permits amplitude selection. When pressed, four softkey choices are available: UIp-p, MASK, XFR50%, and XFR75%. If the MASK, XFR50%, or XFR75% selection is enabled, that selection is displayed instead of the current amplitude.

The UIp-p softkey is used to manually specify a jitter amplitude. When pressed, three softkey choices are available: UP, DOWN, and HELP. The UP and DOWN softkeys increment or decrement the jitter amplitude by .02 UI, respectively; the HELP softkey gives instructions for entering a new amplitude from the MENU keypad. If the UIp-p softkey was previously enabled, the newly specified amplitude can be entered and implemented using the MENU keypad and the **ENTER** key, respectively.

### **Specifications**

Reference Clock:	<ul style="list-style-type: none"> <li>• Internal — 1.544 MHz <math>\pm</math>5 ppm crystal oscillator.</li> <li>• Recovered from DS1 Wideband Jitter option.</li> <li>• External BNC input: GEN CLK IN.</li> </ul>
Frequency:	<ul style="list-style-type: none"> <li>• 10.0 Hz to 40.0 kHz, <math>\pm</math>0.1% (all waveforms).</li> <li>• 3-digit resolution.</li> </ul>
Amplitude:	<ul style="list-style-type: none"> <li>• 0 UI to 13 UI peak-to-peak. .02 UI resolution.</li> </ul>
Modulation Accuracy:	<ul style="list-style-type: none"> <li>• Sine wave — 10 Hz to 40 kHz, <math>\pm</math>5% <math>\pm</math>.05 UI.</li> <li>• Square, Triangle, and Ramp waves — 50 Hz to 5 kHz, <math>\pm</math>7% <math>\pm</math>.06 UI.</li> </ul>
Spectral Purity:	<ul style="list-style-type: none"> <li>• Sine waves greater than or equal to 1.00 UI peak-to-peak; all spurious frequencies 30 dB minimum below fundamental.</li> </ul>
External Modulation:	<ul style="list-style-type: none"> <li>• BNC labeled JITTER MOD IN.</li> <li>• Impedance: 10 k ohms, AC coupled.</li> <li>• Calibration: 1.0 UI/volt.</li> <li>• Frequency response — <math>\pm</math>5% <math>\pm</math>.05 UI, 10 Hz to 40 kHz.; greater than or equal to 20 dB/decade roll-off above 40 kHz.</li> </ul>
Jittered Clock Output:	<ul style="list-style-type: none"> <li>• Available on GEN CLK OUT BNC.</li> </ul>

## **Jitter Options**

### **B.2.4 Masks**

The FIREBERD 6000 DS1 jitter options fully reflect three industry-standard jitter masks and partially reflect two others. The specifications in CCITT Recommendation O.171 and Bell Technical Reference Publications PUB41451, PUB43801, and PUB62411 are all TI standards which specify jitter characteristics for TI equipment and systems. The masks are shown in Figure B-3, along with the sine wave limit for the DS1 Jitter Generation option.

The mask values are used by the DS1 Jitter Spectrum Analysis option to calculate the %MASK in each of the frequency bands. This measurement can be used to determine if the jitter on a TI line exceeds the amount of jitter allowed by the applicable mask. The mask values are also used by the DS1 Jitter Generation option to transmit the amount of jitter cited by a specific mask at the selected frequency.

The desired mask can be selected by setting the **MENU** switch to the **JITTER** category; pressing the **MORE** key causes the **MASK**, **GRAPH**, and **LIST** softkey labels to appear in the display. When the **MASK** softkey is pressed, the previously selected mask is displayed. To change masks, simply press the softkey associated with the desired mask.

The FIREBERD 6000 jitter options fully meet the specifications in CCITT Recommendation O.171, Bell PUB41451, and the 1983 issue of Bell PUB62411. The specifications in Bell PUB43801 and the 1985 issue of Bell PUB62411 are met where those masks are less than 13 UI and between 10 Hz and 40 kHz. Since the Jitter Generation option only operates to 13 UI, any mask that exceeds this value is truncated to 13 UI. The Spectral Analysis option does generate a proper %MASK value for these points in the mask if the jitter measured is within its measurement range.

## **B.3 G.703 JITTER GENERATION AND MEASUREMENT**

This section describes G.703 jitter generation and measurement, specifically:

- G.703 Jitter Generation and Wideband Measurement (Option 6007)
- G.703 Jitter Spectral Analysis (Option 6008)

These options are used with the 2M/n 64 Data Interface (Model 41800), the G.703 64 kb/s Data Interface (Model 30608), or the G.704 2048 kb/s Framing Interface (Model 30609). The presence of G.703 Jitter Generation and Wideband Measurement (option 6007) is required for the G.703 Jitter Spectral Analysis (option 6008) to be installed. (Both options operate simultaneously.)

Jitter on a digital line is the displacement in time of a data pulse from its ideal position. Two parameters are used to characterize jitter. The first is the amplitude of the phase displacement, which varies over time. The amplitude is measured in UI, where one UI is equal to the amount of time associated with one data bit period, or 488 nanoseconds at 2048 kb/s and 15.63 microseconds at 64 kb/s. The second parameter is the frequency at which the amplitude is changing measured in Hz.

The G.703 Jitter Generation and Wideband Measurement option measures jitter over a wide frequency band (20 Hz to 30 kHz for 64 kb/s; 20 Hz to 100 kHz for 2048 kb/s). This measurement follows the guidelines set forth in CCITT Recommendation O.171. The jitter modulator can apply a sine, square, ramp, or triangle wave jitter signal to an internal, external, or recovered reference clock signal. Discussion of the two functions of the G.703 Jitter Generation and Wideband Measurement option is split into two sections: Section B.3.1, Jitter Wideband Measurement; and Section B.3.3, Jitter Generation.

The G.703 Jitter Spectral Analysis option performs multiple-band spectrum analysis on the wideband jitter; this option is discussed in Section B.3.4.

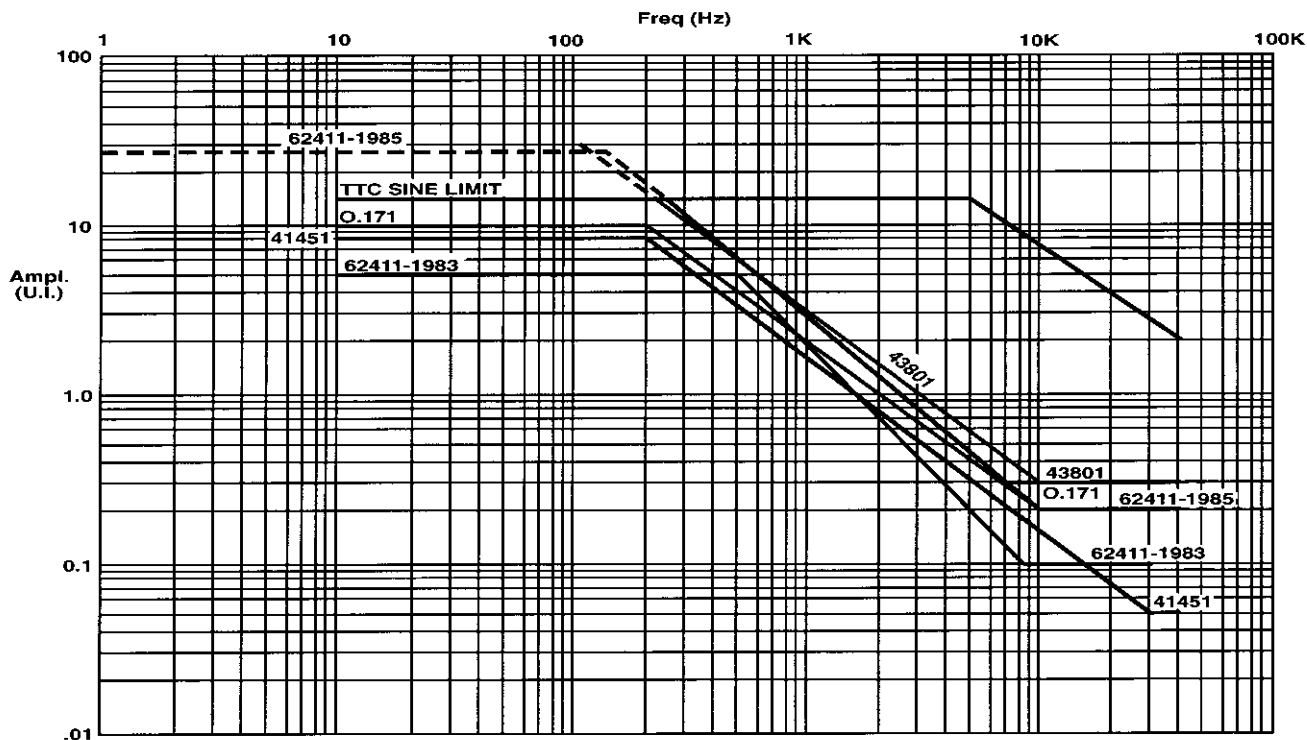

**Figure B-3**  
**Jitter Masks**

### **B.3.1 G.703 Jitter Wideband Measurement**

The G.703 Jitter Generation Wideband Measurement option (Option 6007) receives a jittered clock signal from either the G.703 64 kb/s Data Interface (Model 30608) or the G.704 2048 kb/s Framing Interface (Model 30609). It then demodulates the jittered clock and makes the following measurements.

- Peak-to-peak jitter (1SEC JTR).
- Maximum peak-to-peak jitter (MAX JTR).
- Jitter hits count (JTR HITS).

#### **Functional Description**

The G.703 Jitter Generation and Wideband Measurement option demodulates the jittered clock by generating a voltage that is proportional in amplitude to the amplitude of the phase displacement. This signal is bandwidth-limited based upon the RANGE selection (BAND1; BAND2) and the bit rate. Once it is converted to analog voltage, the jitter signal is sent to the measurement circuitry on the G.703 Jitter Generation and Wideband Measurement option and to the G.703 Jitter Spectral Analysis option (if installed).

In G.703 Jitter Generation and Wideband Measurement, peak-to-peak measurement circuitry tells the FIREBERD 6000 how many unit intervals of jitter are being received. The analog jitter signal is also buffered and sent to the rear panel BNC connector labeled DEMOD JITTER OUT.

## ***Jitter Options***

The G.703 Jitter Generation and Wideband Measurement option also measures jitter hits. A jitter hit occurs when the instantaneous jitter exceeds a user-selectable threshold. It is the absolute value of the demodulated jitter that is measured. Therefore, both positive and negative jitter maxima are compared to the chosen jitter hit threshold.

### **Operation**

Figure B-4 shows the menu tree for all of the G.703 jitter options. The menu tree is accessed by pressing the **MENU** pushbutton switch to the **JITTER** position. The Wideband Jitter Measurement modes are accessed by pressing the **RANGE** softkey. Three more selections then appear in the display: **BAND1**, **BAND2**, and **HELP**. The **RANGE** specified affects both the amplitude and the frequency range of the jitter measured. Table B-3 lists the **RANGE** specifications; the **HELP** softkey also offers a condensed version of this table.

The jitter results **1 SEC JTR**, **MAX JTR**, and **JTR HITS** are found in the **SIGNAL** category of results. The **1 SEC JTR** result is the maximum jitter measured over the last second. The **MAX JTR** result is the maximum of the **1 SEC JTR** results since the last test restart. The **JTR HITS** result is the number of jitter hits that have been counted since the last test restart. These results are not accessible if the Jitter Generation and Wideband Measurement option is not installed, or if an incorrect interface is installed.

Pressing the **HITS** softkey in the **JITTER** menu allows the user to set the jitter hits threshold. (The **HITS** softkey is accessed by pressing the **MORE** key.) The user may enter a hits threshold from the keypad, or may scroll to the desired hit threshold using the **UP** and **DOWN** softkeys. When pressed, the **HELP** softkey displays a range of valid values for the hit threshold based on the currently selected frequency band.

### **Specifications**

The specifications for G.703 wideband jitter measurement and G.703 jitter hits measurement are shown in Tables B-3 and B-4, respectively.

## **B.3.2 MASKS**

The FIREBERD 6000 has a preprogrammed function which can allow the jitter generator amplitude to be set as a function of the jitter frequency and the selected mask. (See Section B.3.3 for jitter generation operation.) The masks found in CCITT Recommendations O.171 and G.823 specify jitter characteristics for G.703 equipment and systems. The masks are shown in Figures B-5 and B-6.

The mask values are used by the G.703 Jitter Spectral Analysis option (Section B.3.4) to calculate the **%MASK** in each of the frequency bands. This measurement can be used to easily determine if the jitter on the digital signal exceeds the amount of jitter allowed by the applicable mask.

The desired mask can be selected by pressing the **MENU** pushbutton switch to select the **JITTER** function; pressing the **MORE** key causes the **MASK**, **GRAPH**, and **LIST** softkey labels to appear in the display. When the **MASK** softkey is pressed, the previously selected mask is displayed. To change masks, simply press the softkey under the desired mask.





**Table B-3**  
**G.703 Wideband Jitter Measurement Specifications**

Interface	Band	40 dB/decade HP Filter -3dB Point	Passband	60 dB/decade LP Filter -3 dB Point	Range (UI p-p)	Measurement Resolution (UI p-p)	Passband Accuracy (UI p-p)	Tolerance
2048 kb/s	Band 1	2Hz	20 Hz—27 kHz	54 kHz	12.00	0.01	±5% ±0.040	±50 ppm
	Band 2	2 Hz	20 Hz—100 kHz	200 kHz	1.200	0.005	±5% ±0.035	
64 kb/s	Band 1	2 Hz	20 Hz—5 kHz	10 kHz	1.500	0.005	±5% ±0.010	±50 ppm
	Band 2	2 Hz	20 Hz—10 kHz	20 kHz	0.300	0.005	±5% ±0.009	

HP= High Pass  
LP= Low Pass

**Table B-4**  
**G.703 Jitter Hits Measurement Specifications**

Interface	Band	Range	Step Size	Accuracy
2048 kb/s	Band 1	0.1—6.0 UI p-p	0.10 UI	±7% ±0.02 UIp
	Band 2	0.05—0.60 UIp	0.05 UI	±7% ±0.02 UIp
64 kb/s	Band 1	0.05—0.75 UIp	0.05 UI	±7% ±0.005 UIp
	Band 2	0.05—0.15 UIp	0.05 UI	±7% ±0.005 UIp

### B.3.3 G.703 JITTER GENERATION

The G.703 Jitter Generation and Wideband Measurement option can phase-modulate the FIREBERD 6000 transmit clock with an internally generated waveform, an external waveform, or a combination of both to transmit jittered data from the G.703 64 kb/s Data Interface and the G.704 2048 kb/s Framing Interface. Jitter can be added to an internal clock, external clock, recovered clock, and looped-thru data. The following list summarizes the features of the G.703 Jitter Generation option.

Frequency:

- User-selectable frequency, 3-digit resolution.
- Automatic sweep.

Amplitude:

- User-selectable amplitude.
- Can automatically set to selected mask level.
- Can automatically set to 50% or 75% of the selected mask level.

Modulation:

- Sine.
- Square.
- Triangle.
- Ramp.
- External.

Clock:

- Internal.
- External.
- Recovered.

### **Functional Description**

The G.703 Jitter Generation and Wideband Measurement option can apply jitter to a digital signal by phase-modulating the digital signal with another waveform. This waveform can be externally supplied or internally generated by the G.703 Jitter Generation and Wideband Measurement option.

There are three clock sources that can be used with the jitter generator. When internal timing is selected, jitter is applied to an internal reference. (The frequency synthesizer is used to set the frequency of the modulating waveform.) An external clock source can be supplied to the rear panel BNC connector labeled GEN CLK IN. The third clock source is the recovered clock from the receiver of the interface in use; this clock source is generally used when inserting jitter on looped data.

There are three parameters to be selected with the G.703 Jitter Generation option: modulation type, frequency, and amplitude. The waveform synthesizer on the G.703 Jitter Generation option can generate a sine, square, ramp, or triangle wave. When any one of these waveforms is selected, it is added to the external waveform, allowing the jitter signal to be extremely versatile. The external signal can also be selected to be the only modulation signal used. If the modulation is turned off, the jitterable clock is no longer the FIREBERD 6000 timing source.

The FIREBERD 6000 frequency synthesizer is used to generate the jitter modulation frequency. The modulation frequency can be selected with 3-digit resolution from 2.00 Hz to 100 kHz at 2048 kb/s, and from 2.00 Hz to 32.0 kHz at 64 kb/s. As an alternative to fixed-frequency jitter modulation, a jitter generation sweep can be used, sweeping through the 58 (37 at 64 kb/s) points listed in Table B-7. Jitter is generated at each frequency for approximately 1 second, unless the G.703 Spectral Analysis option is installed and used in Sweep mode.

The jitter amplitude, either with or without the jitter generator sweep enabled, can be selected manually or can be automatically referenced to the selected jitter mask. The amplitude can be set to MASK, which will set the amplitude of the generated jitter to the level specified by the selected mask for the current jitter frequency. This may be used with the jitter sweep to perform jitter tolerance tests. The jitter generator amplitude can also be set to XFER, which sets the amplitude of the generated jitter to half of the jitter specified by the mask for the current jitter frequency. This may be used with the jitter sweep to perform jitter transfer characteristic tests.

### **Operation**

The FIREBERD 6000 front panel **GEN CLK** switch selects the clock source that is phase-modulated by the G.703 Jitter Generation and Wideband Measurement option. When the **GEN CLK** switch is set to the SYNTH position, an internal reference is selected for jitter modulation. Note that the frequency synthesizer is not selected as the clock source; it is instead used to generate the jitter modulation frequency. Therefore, the message **SYNTH DEFAULTS TO 2048 (64) kHz WITH JIT GEN** is displayed when the SYNTH menu is selected.

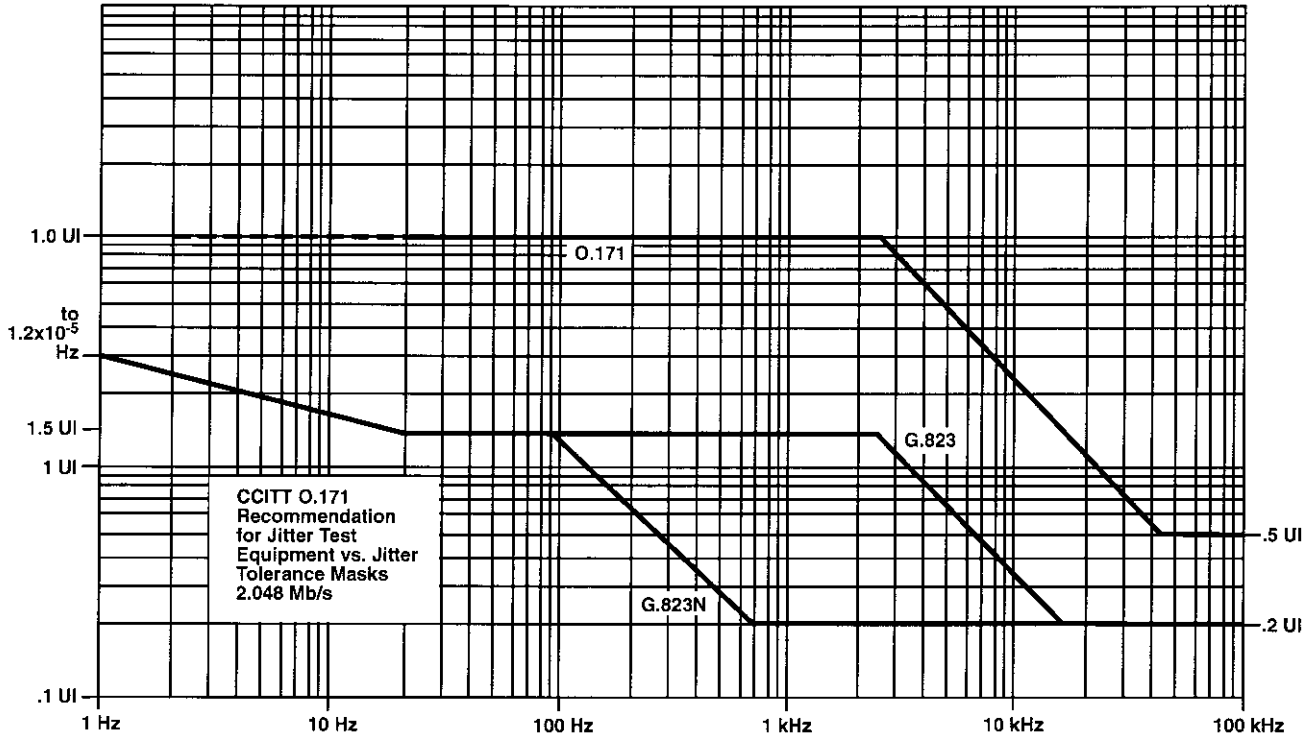

Figure B-5  
2.048 Mb/s CCITT Jitter Masks

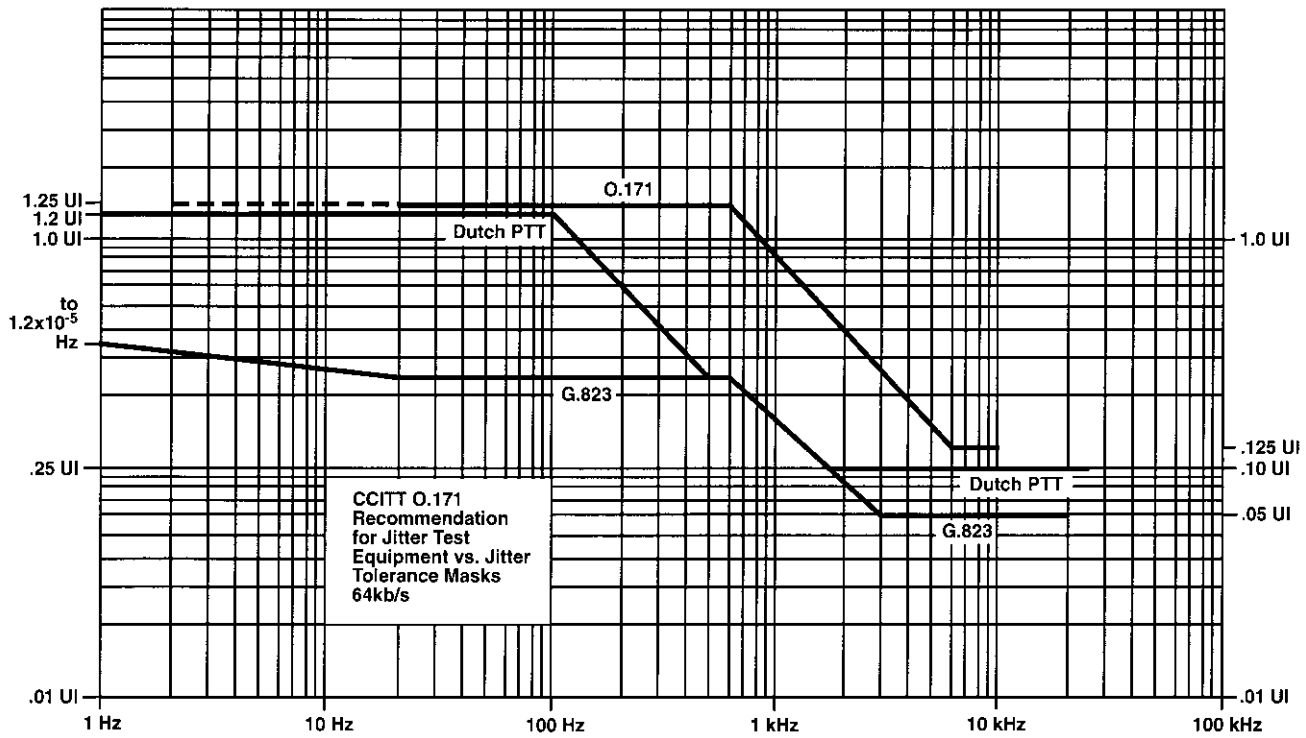

Figure B-6  
64 kb/s CCITT Jitter Masks

When the **GEN CLK** switch is in the BNC position, the GEN CLK IN rear panel BNC connector is selected as the clock source.

**NOTE:** The jitter generator expects a 2.048 MHz clock regardless of the interface in use. When selecting the BNC input as the source of generator timing for the G.703 64 kb/s Data Interface, the external source must be set to 2048 kHz when jitter generation is on and to 64 kHz when jitter generation is off.

When the **GEN CLK** switch is set to the INTF position, the dejitterized, recovered G.703 or G.704 clock is selected.

The rest of the jitter generation functions are accessed through the JITTER menu tree (see Figure B-4). Pressing the GEN softkey accesses the top level of the jitter generation menu; at this level, the frequency and amplitude displayed reflect the actual amount of jitter being generated. When a contention occurs, these actual amounts may differ from the values which the user has selected. A contention occurs when the amplitude selected is greater than the amplitude that can be generated at the selected frequency; a message is displayed to indicate that a contention exists.

**NOTE:** At lower levels in the menu, the display always shows the frequency and amplitude values selected by the user, rather than the frequency and amplitude of the jitter actually being generated. Likewise, when a contention occurs at these lower menu levels, a message is displayed to indicate that a contention exists. To view the actual amount of jitter being generated, the user must return to the top level (GEN softkey) of the menu.

The modulation type may be selected by pressing the MOD softkey. If the modulation is set to Off, the selected generator clock is not modulated and the jitter generator is removed from the FIREBERD 6000 timing path. If the modulation is set to EXT1 or EXT2, the external BNC connector labeled JITTER MOD IN is used as the modulation source. (EXT1 selects BAND 1; EXT2 selects BAND 2) Figures B-7 and B-8 show the modulation limits for each band. The SIN, SQU, TRI, and RAMP softkeys represent the available internally generated waveforms, and the waveform that is selected is added to the external input and used as the modulation waveform.

Pressing the **FREQ** softkey accesses the softkeys SWEEP and Hz, which are used to select the desired frequency. If the SWEEP softkey was previously selected, the message **SWEEP** is displayed instead of the current frequency. Pressing the Hz softkey turns the sweep off and allows the desired frequency to be entered; the last frequency entered is displayed, as are the softkeys UP, DOWN, and HELP.

The UP and DOWN softkeys step through the frequencies corresponding to the spectrum analyzer bands, and the HELP softkey gives instructions for entering a new frequency from the keypad. If the Hz softkey was previously selected, the current jitter generator frequency is displayed and a new frequency can be entered by using the keypad and then pressing the **ENTER** key.

The **AMPL** softkey accesses the softkeys MASK, UIp-p, and XFER, which allow the desired amplitude to be selected. If either the MASK or XFER softkey was previously selected, then MASK or XFER is displayed instead of the current amplitude. Pressing the UIp-p softkey turns off the MASK or XFER function; the last amplitude entered is displayed, and softkeys labeled UP, DOWN, and HELP are displayed. The UP and DOWN softkeys increment or decrement the jitter amplitude by the minimum increment allowed at the bit rate in use, and the HELP softkey gives instructions for entering a new amplitude from the keypad. If the UI softkey was previously selected, the current jitter generator amplitude is displayed and a new amplitude can be entered by using the keypad and the pressing the **ENTER** key.

**NOTE:** If the UI softkey has been selected, the amplitude can be entered directly from the top level (AMPL softkey) of the menu.

## **Specifications**

Jitter Generator  
Amplitude:

- See Table B-5.

Jitter Generator Internal  
Generator Frequency:

- See Table B-6.

External Modulation:

- BNC labeled JITTER MOD IN.
- Impedance: 10 k-ohms  $\pm 5\%$ ; DC coupled.

## Jitter Options

- Maximum Input:
- $\pm 25$  volts.
- Reference Clock Sources:
- Internal:  $\pm 5$  ppm, 4.096 MHz crystal oscillator.
  - Recovered: Dejittered clock.
  - External BNC Input: GEN CLK IN; 50 ohm (resistive termination); 1.5V p-p or greater unipolar or bipolar signal.
- Jittered Clock Output (BNC):
- GEN CLK OUT, 50 ohm load minimum; TTL level; 50%  $\pm 5\%$  duty cycle square wave.
- 2048 kb/s Generator Sweep:
- The sine wave generator may be set up to automatically sweep through a number of frequencies with jitter amplitudes defined by one of the following jitter masks: O.171, G.823, or G.823N (see Figure B-5).
- 64 kb/s Generator Sweep:
- The sine wave generator may be set up to automatically sweep through a number of frequencies with jitter amplitudes defined by one of the following jitter masks: O.171, G.823, or Dutch PTT (see Figure B-6).
- Mask Sweep:
- Jitter amplitude equals that defined by the mask.
- Transfer Characteristic Sweep:
- Equals one-half or three-quarters of the jitter amplitude defined by the mask.

**Table B-5**  
**G.703 Jitter Generator Amplitude Specifications**

Interface	Sinusoidal Modulation				Non-Sinusoidal Modulation		
	1.0 UI=	Maximum	Resolution	Accuracy	Maximum	Resolution	Accuracy
2048 kb/s	488 ns.	12.0 UI p-p	0.02 UI p-p	$\pm 5\% \pm 0.05$ UI p-p	10.00 UI p-p	0.02 UI p-p	$\pm 7\% \pm 0.05$ UI p-p
64 kb/s	15.63 ms.	1.500 UI p-p	0.005 UI p-p	$\pm 5\% \pm 0.013$ UI p-p	1.250 UI p-p	0.005 UI p-p	$\pm 7\% \pm 0.013$ UI p-p

**Table B-6**  
**G.703 Jitter Generator Internal Generator Frequency Specifications**

Interface	Sinusoidal Modulation Range	Non-Sinusoidal Modulation Range	Resolution	Accuracy
2048 kb/s	2.0 Hz to 100 kHz	50.0 Hz to 5.00 kHz	3 significant digits	$\pm 0.1\%$ of setting
64 kb/s	2.0 Hz to 32.0 kHz	50.0 Hz to 1.00 kHz	3 significant digits	$\pm 0.1\%$ of setting

### **B.3.4 G.703 Jitter Spectral Analysis Option**

The G.703 Jitter Spectral Analysis option (option 6008) consists of a printed circuit board that plugs into the G.703 Jitter Generation and Wideband Measurement option. At 2048 kb/s, the spectrum analyzer measures the maximum peak-to-peak jitter in 58 frequency bands from 10 Hz to 100 kHz and displays the result in UI. At 64 kb/s, the spectrum analyzer measures the maximum peak-to-peak jitter in 37 frequency bands from 10 Hz to 30 kHz and displays the result in UI. Refer to Table B-7 for a list of the frequency bands.

The G.703 Jitter Spectral Analysis option enables the following measurements.

- Jitter amplitude measured in UI peak-to-peak with a continuous sweep of 58 (37 at 64 kb/s) frequency bands.
- Continuous jitter amplitude measurement in UI peak-to-peak at one frequency.
- Percent of mask for each band.

The G.703 Jitter Spectral Analysis option can only be used with the G.703 Jitter Generation and Wideband Measurement option.

#### **Functional Description**

The G.703 Jitter Spectral Analysis option is offered with the FIREBERD 6000 to allow the user to determine the frequency content of timing jitter in a digital system. This is accomplished by filtering the wideband jitter signal obtained from the G.703 Jitter Generation and Wideband Measurement option into 58 (37 at 64 kb/s) discrete frequency bands. The output of each filter in turn goes to a peak-to-peak measurement circuit. The G.703 Jitter Spectral Analysis option can either (1) continuously monitor one of the frequency bands and measure the jitter amplitude for that band, or (2) continually sweep through the frequency bands. When the sweep is enabled, the amplitude stored and displayed for each frequency band is the maximum amplitude value recorded since the last test restart.

The sweep function of the G.703 Jitter Spectral Analysis option operates synchronously with the generator sweep function of the G.703 Jitter Generation and Wideband Measurement option. The G.703 jitter generator generates jitter at a specific frequency, the spectrum analyzer measures that frequency band, and both options will increment to the next frequency band. This capability can be used to test equipment for bit errors or jitter attenuation characteristics. (See the Functional Description in Section B.3.3 for more information.)

The time required to complete one sweep of the spectrum analyzer is approximately 45 to 50 seconds with jitter generation disabled, and approximately 2 to 2 1/2 minutes with jitter generation enabled.

Care should be exercised in comparing the spectral analysis results. The Wideband Jitter option makes continuous measurements over the entire frequency range for 64 kb/s and 2048 kb/s. The result obtained with that option is a true indication of the overall maximum jitter in that band. This is in contrast to the spectrum analyzer which looks at a much narrower bandwidth for each measurement. Real-world jitter is likely to be non-sinusoidal, containing frequency components that do not add directly. As a result, it is important that the wideband measurement be used with the spectrum analyzer measurements in determining system performance.

Since the Spectral Analysis option (6008) uses the signal from the G.703 Jitter Generation and Wideband Measurement option (6007), the RANGE selection affects the amount of jitter that can be measured by Option 6008. In both BAND 1 and BAND2, however, the Spectral Analysis functions cover the full frequency range for the interface in use.

#### **Operation**

The G.703 Jitter Spectral Analysis measurement modes are accessed in the JITTER menu tree (see Figure B-4) by pressing the S/A softkey. At this level in the menu, the current frequency and the measured amplitude at that frequency are displayed. If the sweep is disabled, the frequency displayed is the only one for which measurements are taken. The display is updated each time

## **Jitter Options**

the amplitude measurement is completed. If the sweep is enabled, the frequency displayed sweeps along with the measurement, which allows the user to know the status of the sweep at any point in time. In addition, the amplitude displayed for each frequency is the maximum amplitude measured in that band since the last test restart.

Pressing the SWEEP softkey causes the selections ON and OFF to be displayed; selecting either the ON or OFF softkey places the sweep function in the corresponding state. Pressing the FREQ softkey accesses the softkeys UP and DOWN, which can be used to scroll through the frequency bands. When the sweep is enabled, the amplitude displayed is the maximum value stored for that band. When the sweep is disabled, either of the UP or DOWN softkeys changes the frequency band currently being measured to the band selected by the softkey.

The following results are available under the ANALYSIS RESULTS function of the SIGNAL category for G.703 Jitter Spectral Analysis:

### **1. Maximum % of Mask (%MASK)**

Each time the jitter spectrum analyzer takes a reading, the ratio of the measured jitter amplitude to the reference jitter mask's value at this point is calculated. If the spectrum analyzer is sweeping, then the maximum value of that ratio since the beginning of the test is displayed as a percentage, and a value less than 100% indicates that during the test no spectrum analyzer reading exceeded the reference mask. If the spectrum analyzer is not sweeping, then the ratio of the last spectrum analyzer reading to the reference mask at that frequency is displayed as a percentage.

### **2. S/A X.XX k**

The amplitude of the jitter at the frequency currently measured by the spectrum analyzer. If the spectrum analyzer sweep is enabled, this result sweeps also.

When the PEAK softkey is pressed, the PEAKUP and PEAKDN softkeys allow the user to quickly find any peaks in the spectrum when the sweep is enabled. A peak is defined as those bands where the jitter is worst in relation to the selected jitter mask. The PEAKUP softkey finds the next higher frequency jitter peak and the PEAKDN softkey finds the next lower frequency jitter peak. Since there are no peaks when the sweep is disabled, the PEAK softkey is not visible if the sweep is off.

Pressing the LIST softkey in the JITTER menu sends a list of the jitter spectrum analyzer frequency band measurements and their corresponding %MASK values to the printer port. If the jitter spectrum analyzer sweep is turned off, only one frequency in the list is printed and the others remain blank.

Pressing the GRAPH softkey in the JITTER menu generates a graph of the G.703 Jitter Spectral Analysis results. The graphics are Epson-compatible and can be used with TTC's PR-85 Printer. The results are graphed only when the jitter spectrum analyzer sweep is on.

## **Specifications**

Frequency Points/ Measurement Bandwidths:	<ul style="list-style-type: none"><li>• See Table B-7.</li></ul>
Filter Bandwidths:	<ul style="list-style-type: none"><li>• See Figure B-2 and Table B-2.</li></ul>
Range:	
2048 kb/s	<ul style="list-style-type: none"><li>• BAND 1 — Up to 12.00 UI p-p.</li><li>• BAND 2 — Up to 1.200 UI p-p.</li></ul>
64 kb/s	<ul style="list-style-type: none"><li>• BAND 1 — Up to 1.500 UI p-p.</li><li>• BAND 2 — Up to 0.300 UI p-p.</li></ul>



Resolution:  
2048 kb/s

- BAND 1 — 0.00 to 2.00 UI p-p in 0.01 UI p-p steps; 2.00 to 12.00 UI p-p in 0.05 UI p-p steps.
- BAND 2 — 0.000 to 0.500 UI p-p in 0.005 UI p-p steps; 0.500 to 1.200 UI p-p in 0.025 UI p-p steps.

64 kb/s

- BAND 1 — 0.000 to 0.250 UI p-p in 0.005 UI p-p steps; 0.250 to 1.500 UI p-p in 0.025 UI p-p steps.
- BAND 2 — 0.000 to 0.050 UI p-p in 0.005 UI p-p steps; 0.050 to 0.300 UI p-p in 0.025 UI p-p steps.

Accuracy:

2048 kb/s

- BAND 1 —  $\pm 10\% \pm 0.08$  UI p-p.
- BAND 2 —  $\pm 10\% \pm 0.05$  UI p-p.

64 kb/s

- BAND 1 —  $\pm 10\% \pm 0.02$  UI p-p.
- BAND 2 —  $\pm 10\% \pm 0.013$  UI p-p.

**Table B-7**  
**Frequency Points and Measurement Bandwidths**

10 Hz BW	33 Hz BW	100 Hz BW	333 Hz BW	1 kHz BW	3.3kHzBW
10 Hz	100 Hz	300 Hz	1.00 kHz	3.00 kHz	10.0 kHz
20 Hz	133 Hz	400 Hz	1.33 kHz	4.00 kHz	13.3 kHz
30 Hz	166 Hz	500 Hz	1.66 kHz	5.00 kHz	16.6 kHz
40 Hz	200 Hz	600 Hz	2.00 kHz	6.00 kHz	20.0 kHz
50 Hz	233 Hz	700 Hz	2.33 kHz	7.00 kHz	23.3 kHz
60 Hz		800 Hz		8.00 kHz	26.6 kHz
70 Hz					30.0 kHz*
80 Hz					33.3 kHz
					36.6 kHz
					40.0 kHz
					43.3 kHz
					46.6 kHz
					50.0 kHz
					53.3 kHz
					56.6 kHz
					60.0 kHz
					63.3 kHz
					66.6 kHz
					70.0 kHz
					73.3 kHz
					76.6 kHz
					80.0 kHz
					83.3 kHz
					86.6 kHz
					90.0 kHz
					93.3 kHz
					96.6 kHz
					100.0 kHz

\*Stop here at 64 Kb/s.



## APPENDIX C

### CCITT G.821 PERFORMANCE ANALYSIS

#### C.1 INTRODUCTION

This appendix discusses the criteria for performance analysis, the concept of available time versus unavailable time, and degraded minutes as specified in CCITT Recommendation G.821. This discussion is provided to familiarize users with the G.821 Performance results option installed (Option 4004).

#### C.2 PERFORMANCE ANALYSIS RESULTS

The performance results listed in Table C-1 are derived by observing the received bit error counts and received bit counts at 1-second intervals, and classifying each 1-second interval as either available, unavailable, severely errored, or error free seconds. This division of test time is illustrated in Figure C-1. Further calculations yield the number and percentage of degraded minutes, and percentages of available, severely errored, and error free seconds.

**Table C-1**  
**Performance Category Results**

Displayed Results:	Description:
%AVL SEC	Percent of Available Seconds
%DEG MIN	Percent of Degraded Minutes
%SES	Percent of Severely Errored Seconds
AVL SEC	Available Seconds
DEG MIN	Degraded Minutes
G %EFS	G.821 Percent of Error Free Seconds
G EFS	G.821 Error Free Seconds
GERR SEC	G.821 Errored Seconds
SES	Severely Errored Seconds
UNA SEC	Unavailable Seconds
BER-SES	Bit Error Rate Minus SES
ERR-SES	Bit Errors Rate Minus SES

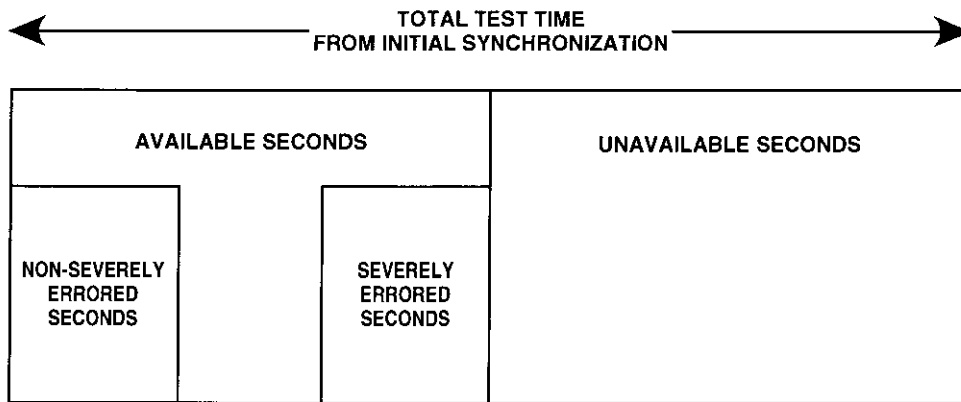

**Figure C-1**  
**Division of Test Seconds for Performance Analysis**

### C.3 DETERMINING AVAILABLE AND UNAVAILABLE SECONDS

CCITT Recommendation G.821 defines available and unavailable time as follows.

“A period of unavailable time begins when the bit error rate (BER) in each second is worse than  $10^{-3}$  for a period of 10 consecutive seconds. These 10 seconds are considered to be unavailable time. The period of unavailable time terminates when the BER in each second is better than  $10^{-3}$  for a period of 10 consecutive seconds. These 10 seconds are considered to be available time.”

Available time and unavailable time are measured in seconds — available seconds (AVL SEC) and unavailable seconds (UNA SEC), respectively. All seconds after initial pattern synchronization must fall into one of the two categories (total AVL SEC + total UNA SEC = total seconds after initial pattern synchronization).

After initial pattern synchronization, seconds are considered to be available time; the AVL SEC begin counting (seconds before initial pattern synchronization are not included in performance analysis). These seconds continue to be counted until 10 consecutive seconds, each with a BER worse than  $10^{-3}$ , occur. A sliding window, 10 seconds in length, is used to detect this transition from available time to unavailable time and vice versa.

As an example, assume a test begins and continues to run for 25 seconds and each of those 25 seconds has a BER better than or equal to  $10^{-3}$ . After the initial pattern synchronization, the seconds are considered to be available time, so the AVL SEC count at this point is 25 as shown in Figure C-2. In the 26th second, the BER becomes worse than  $10^{-3}$ . The same for the 27th and 28th seconds. In the 29th second, the BER improves to better than or equal to  $10^{-3}$ . All 29 seconds are a part of available time and are, therefore, counted as AVL SEC.

Even though there were 3 consecutive seconds (the 26th, 27th, and 28th) which each had a BER worse than  $10^{-3}$ , 10 such consecutive seconds are required to make the transition to unavailable time. Those 3 individual seconds are still in available time and they are counted as AVL SEC.

The 3 seconds with a BER worse than  $10^{-3}$  are also included in the count of severely errored seconds (SES), which are those seconds with a BER worse than  $10^{-3}$  that occur in available time. A signal loss second or a second in which pattern synchronization is lost is also considered to be a second with a BER worse than  $10^{-3}$ . Therefore, the current test result values for the AVL SEC count = 29; the SES count = 3 and the UNA SEC count = 0.

sec 20	sec 21	sec 22	sec 23	sec 24	sec 25	sec 26	sec 27	sec 28	sec 29
BER	BER	BER	BER	BER	BER	BER	BER	BER	BER
<=	<=	<=	<=	<=	<=	>	>	>	<=

**Figure C-2**  
Sliding Window After 29th Test Second Still in Available Time

sec 79	sec 80	sec 81	sec 82	sec 83	sec 84	sec 85	sec 86	sec 87	sec 88
BER	BER	BER	BER	BER	BER	BER	BER	BER	BER
<=	>	>	>	>	>	>	>	>	>

**Figure C-3**  
Sliding Window After 88th Test Second Still in Available Time

The same test continues to run and remains in available time. In the 80th second, the BER for that second is worse than  $10^{-3}$  as shown in Figure C-3. The BER for the 81st through the 85th seconds is also worse than  $10^{-3}$ . In the 86th second, pattern synchronization is lost. This also continues for the 87th and 88th seconds. We now have 9 consecutive seconds each of which has a BER worse than  $10^{-3}$ . As each of these seconds occurs, we are still in available time, so they are counted as AVL SEC and SES. The transition has not been made from available time to unavailable time.

Figure C-4 shows the 89th second also has a BER worse than  $10^{-3}$ . At this point, the AVL SEC count = 89, the SES count = 13, and the UNA SEC count = 0. However, the sliding window now contains 10 consecutive seconds each having a BER worse than  $10^{-3}$ . At this point the transition is made to unavailable time.

sec 80	sec 81	sec 82	sec 83	sec 84	sec 85	sec 86	sec 87	sec 88	sec 89
BER	BER	BER	BER	BER	BER	BER	BER	BER	BER
>	>	>	>	>	>	>	>	>	>

**Figure C-4**  
Sliding Window After 89th Test Second Transition to Unavailable Time

Those 10 seconds which had been counted as AVL SEC are deducted from the AVL SEC count and are added to the UNA SEC count; the AVL SEC count becomes 79, and the UNA SEC count becomes 10. Those same 10 seconds were also included in the SES count. However, SES is limited to only those seconds in available time which have a BER worse than  $10^{-3}$ ; therefore, those last consecutive 10 seconds must also be deducted from the SES count (the SES count is updated to 3).

Once the transition occurs from available time to unavailable time, all seconds are counted as UNA SEC until 10 consecutive seconds occur each with a BER better than  $10^{-3}$ . As the sample test continues, the 90th through 150th seconds each have a BER worse than or equal to  $10^{-3}$ . We are still in unavailable time, so these seconds are counted as UNA SEC; now the total AVL SEC count = 79 and the total UNA SEC count = 71.

<b>sec</b>	<b>sec</b>	<b>sec</b>	<b>sec</b>	<b>sec</b>	<b>sec</b>	<b>sec</b>	<b>sec</b>	<b>sec</b>	<b>sec</b>
<b>151</b>	<b>152</b>	<b>153</b>	<b>154</b>	<b>155</b>	<b>156</b>	<b>157</b>	<b>158</b>	<b>159</b>	<b>160</b>
<b>BER</b>	<b>BER</b>	<b>BER</b>	<b>BER</b>	<b>BER</b>	<b>BER</b>	<b>BER</b>	<b>BER</b>	<b>BER</b>	<b>BER</b>
<b>&lt;</b>	<b>&lt;</b>	<b>&lt;</b>	<b>&lt;</b>	<b>&lt;</b>	<b>&lt;</b>	<b>&lt;</b>	<b>&lt;</b>	<b>&lt;</b>	<b>&lt;</b>

**Figure C-5**  
**Sliding Window After 160th Test Second**  
**Transition to Available Time**

Beginning with the 151st second, the BER for that second falls below  $10^{-3}$  as shown in Figure C-5. It is still counted as an UNA SEC since we are still in unavailable time and the transition has not been made to available time. A BER better than  $10^{-3}$  also occurs for the 152nd through the 160th seconds. Since there are now 10 consecutive seconds with a BER better than  $10^{-3}$ , the transition is made from unavailable time to available time.

As each of these 10 seconds occurred, it was added to the UNA SEC count (UNA SEC = 81, AVL SEC = 79, and SES = 3). Now that those consecutive seconds have triggered the transition to available time, they are deducted from the UNA SEC count and added to the AVL SEC count. Now the UNA SEC count = 71 and the AVL SEC count = 89.

The monitoring of available and unavailable time continues for the duration of the test.

#### **C.4 DETERMINING DEGRADED MINUTES**

Degraded minutes (DEG MIN) is an error analysis result that is affected by available and unavailable time. DEG MIN is a count of the number of minutes during which an average BER worse than  $10^{-6}$  occurs. The 1-minute intervals are derived by removing UNA SEC and SES from the total test time and then consecutively grouping the remaining seconds into blocks of 60. The average BER is calculated for the block of 60 seconds and, if it is worse than  $10^{-6}$ , the block is counted as a degraded minute.

In the transition from available time to unavailable time, the DEG MIN result is unaffected. This is because a switch to unavailable time requires 10 consecutive seconds each with a BER worse than  $10^{-3}$ . Any second in available time with a BER worse than  $10^{-3}$  is considered to be a severely errored second and, therefore, not included in the accumulation of seconds used to calculate DEG MIN.

Moving from unavailable time to available time may affect the DEG MIN count. While in unavailable time, 10 consecutive seconds each with a BER worse than  $10^{-3}$  are required for the transition to available time. When this happens, those 10 seconds are subtracted from the UNA SEC count and are added to the AVL SEC count. Since these seconds are now considered to be a part of available time and they are not SES, they are included in the calculation of DEG MIN.

## APPENDIX D HEXADECIMAL CONVERSION TABLE

HEX	BAUDOT		BCDIC		ASCII	EBCDIC
	LTRS	FIGS	UPPER	LOWER		
00	Blank	Blank	Space	Space	NUL (Blank)	NUL (Null)
01	E	3	=	1	SOH (Start of Header)	SOH (Start of Header)
02	LF	LF	<	2	STX (Start of Text)	STX (Start of Text)
03	A	-	;	3	EXT (End of Text)	EXT (End of Text)
04	Space	Space	:	4	EOT (End of Transmission)	PF(Punch Off)
05	S	' or BELL	%	5	ENQ (Enquiry)	HT (Horizontal Tab)
06	I	8	'	6	ACK (Acknowledge)	LC (Lower Case)
07	U	7	>	7	BEL (Bell)	DEL (Delete)
08	CR	CR	*	8	BS (Backspace)	
09	D	WRU or \$	(	9	HT (Horizontal Tabulation)	RLF
0A	R	4	)	0	LF (Line Feed)	SMM (Start Manual Message)
0B	J	BELL or ' "	"	#	VT (Vertical Tabulation)	VT (Vertical Tabulation)
0C	N	,	DC2	DC2	FF (Form Feed)	FF (Form Feed)
0D	F	!	RS	RS	CR (Carriage Return)	CR (Carriage Return)
0E	C	:	UPPER	UPPER	SO (Shift Out)	SO (Shift Out)
0F	K	(	EOT	EOT	SI (Shift In)	SI (Shift In)
10	T	5	CAN	@	DLE (Data Link Escape)	DLE (Data Link Escape)
11	Z	+ or "	?	/	DC1 (Device Control 1)	DC1 (Device Control 1)
12	L	)	S	s	DC2 (Device Control 2)	DC2 (Device Control 2)
13	W	2	T	t	DC3 (Device Control 3)	DC3 (Device Control 3)
14	H	#	U	u	DC4 (Device Control 4)	RES (Restore)
15	Y	6	V	v	NAK (Negative Acknowledge)	NL (New Line)
16	P	0	W	w	SYN (Synchronization)	BS (Backspace)
17	Q	1	X	x	ETB (End of Text Block)	IL (Idle)
18	O	9	Y	y	CAN (Cancel)	CAN (Cancel)
19	B	?	Z	z	EM (End of Medium)	EM (End of Medium)
1A	G	&			SUB (Substitute)	CC (Cursor Control)
1B	FIGS	FIGS	.	.	ESC (Escape)	CUI (Customer Use 1)
1C	M	.	BEL	BEL	FS (File Separator)	IFS (Interchangeable File Sep.)
1D	X	/	LF	LF	GS (Group Separator)	IGS (Interchangeable Group Sep.)
1E	V	= or ;	ETB	ETB	RS (Record Separator)	IRS (Interchangeable Record Sep.)
1F	LTRS	LTRS	DC3	DC3	US (Unit Separator)	IUS (Interchangeable Unit Sep.)

## HEXADECIMAL CONVERSION TABLE (CONTINUED)

HEX	BAUDOT		BCDIC		ASCII	EBCDIC
	LTRS	FIGS	UPPER	LOWER		
20	Blank	Blank	-	-	SP	DS (Digit Select)
21	E	3	J	j	!	SOS (Start of Significance)
22	LF	LF	K	k	"	FS (Field Separator)
23	A	-	L	l	#	
24	Space	Space	M	m	\$	BYP (Bypass)
25	S	' or BELL	N	n	%	LF (Line Feed)
26	I	8	O	o	&	ETB (End Transmission Block)
27	U	7	P	p	' (Single Closing Quote)	ESC (Escape)
28	CR	CR	Q	q	(	
29	D	WRU or \$	R	r	)	
2A	R	4			*	SM (Set Mode)
2B	J	BELL or '	!	\$	+	CU2 (Customer Use 2)
2C	N	,	DC4	DC4	, (Comma)	
2D	F	!	CR	CR	- (Hyphen)	ENQ (Enquiry)
2E	C	:	BS	BS	. (Period)	ACK (Acknowledge)
2F	K	(	DLE	DLE	/	BEL (Bell)
30	T	5	+	&	0	
31	Z	+ or "	A	a	1	
32	L	)	B	b	2	SYN (Synchronous Idle)
33	W	2	C	c	3	
34	H	#	D	d	4	PN (Punch On)
35	Y	6	E	e	5	RS (Reader Stop)
36	P	0	F	f	6	UC (Upper Case)
37	Q	1	G	g	7	EOT (End of Transmission)
38	O	9	H	h	8	
39	B	?	I	i	9	
3A	G	&			:	
3B	FIGS	FIGS	.	.	;	CU3 (Customer Use 3)
3C	M	.	DC1	DC1	< (Less Than)	DC4 (Device Control 4)
3D	X	/	HT	HT	=	NAK (Negative Acknowledge)
3E	V	= or ;	LOWER	LOWER	> (Greater Than)	
3F	LTRS	LTRS	DEL	DEL	?	SUB (Substitute)



## HEXADECIMAL CONVERSION TABLE (CONTINUED)

HEX	BAUDOT		BCDIC		ASCII	EBCDIC
	LTRS	FIGS	UPPER	LOWER		
40	Blank	Blank	Space	Space	@	SP (Space)
41	E	3	=	1	A	
42	LF	LF	<	2	B	
43	A	-	;	3	C	
44	Space	Space	:	4	D	
45	S	' or BELL	%	5	E	
46	I	8	'	6	F	
47	U	7	>	7	G	
48	CR	CR	*	8	H	
49	D	WRU or \$	(	9	I	
4A	R	4	)	0	J	¢
4B	J	BELL or '	"	#	K	. (Period)
4C	N	,	DC2	DC2	L	< (Less Than)
4D	F	!	RS	RS	M	(
4E	C	:	UPPER	UPPER	N	+
4F	K	(	EOT	EOT	O	(Logical OR)
50	T	5	CAN	@	P	&
51	Z	+ or "	?	/	Q	
52	L	)	S	s	R	
53	W	2	T	t	S	
54	H	#	U	u	T	
55	Y	6	V	v	U	
56	P	0	W	w	V	
57	Q	1	X	x	W	
58	O	9	Y	y	X	
59	B	?	Z	z	Y	
5A	G	&			Z	!
5B	FIGS	FIGS	,	,	[ (Opening Bracket)	\$
5C	M	.	BEL	BEL	\ (Reverse Slant)	*
5D	X	/	LF	LF	] (Closing Bracket)	)
5E	V	= or ;	ETB	ETB	^ (Circumflex)	:
5F	LTRS	LTRS	DC3	DC3	_ (Underline)	¬ (Logical NOT)

## HEXADECIMAL CONVERSION TABLE (CONTINUED)

HEX	BAUDOT		BCDIC		ASCII	EBCDIC
	LTRS	FIGS	UPPER	LOWER		
60	Blank	Blank	-	-	` (Opening Single Quote)	- (Hyphen)
61	E	3	J	j	a	/
62	LF	LF	K	k	b	
63	A	-	L	l	c	
64	Space	Space	M	m	d	
65	S	' or BELL	N	n	e	
66	I	8	O	o	f	
67	U	7	P	p	g	
68	CR	CR	Q	q	h	
69	D	WRU or \$	R	r	i	
6A	R	4			j	(Vertical Line)
6B	J	BELL or '	!	\$	k	, (Comma)
6C	N	,	DC4	DC4	l	%
6D	F	!	CR	CR	m	_ (Underline)
6E	C	:	BS	BS	n	> (Greater Than )
6F	K	(	DLE	DLE	o	?
70	T	5	+	&	p	
71	Z	+ or "	A	a	q	
72	L	)	B	b	r	
73	W	2	C	c	s	
74	H	#	D	d	t	
75	Y	6	E	e	u	
76	P	0	F	f	v	
77	Q	1	G	g	w	
78	O	9	H	h	x	
79	B	?	I	i	y	` (Opening Quote)
7A	G	&			z	:
7B	FIGS	FIGS	.	.	{ (Opening Brace)	#
7C	M	.	DC1	DC1	(Vertical Line)	@
7D	X	/	HT	HT	} (Closing Brace)	'
7E	V	= or ;	LOWER	LOWER	~ (Overline Tilde)	=
7F	LTRS	LTRS	DEL	DEL	DEL (Delete/Rubout)	"

## HEXADECIMAL CONVERSION TABLE (CONTINUED)

HEX	BAUDOT		BCDIC		ASCII	EBCDIC
	LTRS	FIGS	UPPER	LOWER		
80	Blank	Blank	Space	Space	NUL (Blank)	
81	E	3	=	1	SOH (Start of Header)	a
82	LF	LF	<	2	STX (Start of Text)	b
83	A	-	:	3	EXT (End of Text)	c
84	Space	Space	:	4	EOT (End of Transmission)	d
85	S	' or BELL	%	5	ENQ (Enquiry)	e
86	I	8	'	6	ACK (Acknowledge)	f
87	U	7	>	7	BEL (Bell)	g
88	CR	CR	*	8	BS (Backspace)	h
89	D	WRU or \$	(	9	HT (Horizontal Tabulation)	i
8A	R	4	)	0	LF (Line Feed)	
8B	J	BELL or '	"	#	VT (Vertical Tabulation)	
8C	N	,	DC2	DC2	FF (Form Feed)	
8D	F	!	RS	RS	CR (Carriage Return)	
8E	C	:	UPPER	UPPER	SO (Shift Out)	
8F	K	(	EOT	EOT	SI (Shift In)	
90	T	5	CAN	@	DLE (Data Link Escape)	
91	Z	+ or "	?	/	DC1 (Device Control 1)	j
92	L	)	S	s	DC2 (Device Control 2)	k
93	W	2	T	t	DC3 (Device Control 3)	l
94	H	#	U	u	DC4 (Device Control 4)	m
95	Y	6	V	v	NAK (Negative Acknowledge)	n
96	P	0	W	w	SYN (Synchronization)	o
97	Q	1	X	x	ETB (End of Text Block)	p
98	O	9	Y	y	CAN (Cancel)	q
99	B	?	Z	z	EM (End of Medium)	r
9A	G	&			SUB (Substitute)	
9B	FIGS	FIGS	,	,	ESC (Escape)	
9C	M	.	BEL	BEL	FS (File Separator)	
9D	X	/	LF	LF	GS (Group Separator)	
9E	V	= or ;	ETB	ETB	RS (Record Separator)	
9F	LTRS	LTRS	DC3	DC3	US (Unit Separator)	

## HEXADECIMAL CONVERSION TABLE (CONTINUED)

HEX	BAUDOT		BCDIC		ASCII	EBCDIC
	LTRS	FIGS	UPPER	LOWER		
A0	Blank	Blank	-	-	SP	
A1	E	3	J	j	!	~
A2	LF	LF	K	k	"	s
A3	A	-	L	l	#	t
A4	Space	Space	M	m	\$	u
A5	S	' or BELL	N	n	%	v
A6	I	8	O	o	&	w
A7	U	7	P	p	' (Single Closing Quote)	x
A8	CR	CR	Q	q	(	y
A9	D	WRU or \$	R	r	)	z
AA	R	4			*	
AB	J	BELL or '	!	S	+	
AC	N	,	DC4	DC4	, (Comma)	
AD	F	!	CR	CR	- (Hyphen)	
AE	C	:	BS	BS	. (Period)	
AF	K	(	DLE	DLE	/	
B0	T	5	+	&	0	
B1	Z	+ or "	A	a	1	
B2	L	)	B	b	2	
B3	W	2	C	c	3	
B4	H	#	D	d	4	
B5	Y	6	E	e	5	
B6	P	0	F	f	6	
B7	Q	1	G	g	7	
B8	O	9	H	h	8	
B9	B	?	I	i	9	
BA	G	&			:	
BB	FIGS	FIGS	.	.	;	
BC	M	.	DC1	DC1	< (Less Than)	
BD	X	/	HT	HT	=	
BE	V	= or ;	LOWER	LOWER	> (Greater Than)	
BF	LTRS	LTRS	DEL	DEL	?	

## HEXADECIMAL CONVERSION TABLE (CONTINUED)

HEX	BAUDOT		BCDIC		ASCII	EBCDIC
	LTRS	FIGS	UPPER	LOWER		
C0	Blank	Blank	Space	Space	@	{
C1	E	3	=	1	A	A
C2	LF	LF	<	2	B	B
C3	A	-	;	3	C	C
C4	Space	Space	:	4	D	D
C5	S	' or BELL	%	5	E	E
C6	I	8	'	6	F	F
C7	U	7	>	7	G	G
C8	CR	CR	*	8	H	H
C9	D	WRU or \$	(	9	I	I
CA	R	4	)	0	J	
CB	J	BELL or '	"	#	K	
CC	N	,	DC2	DC2	L	
CD	F	!	RS	RS	M	
CE	C	:	UPPER	UPPER	N	
CF	K	(	EOT	EOT	O	
D0	T	5	CAN	@	P	}
D1	Z	+ or "	?	/	Q	J
D2	L	)	S	s	R	K
D3	W	2	T	t	S	L
D4	H	#	U	u	T	M
D5	Y	6	V	v	U	N
D6	P	0	W	w	V	O
D7	Q	1	X	x	W	P
D8	O	9	Y	y	X	Q
D9	B	?	Z	z	Y	R
DA	G	&			Z	
DB	FIGS	FIGS	,	,	(Opening Bracket)	
DC	M	.	BEL	BEL	\(Reverse Slant)	
DD	X	/	LF	LF	(Closing Bracket)	
DE	V	= or ;	ETB	ETB	^(Circumflex)	
DF	LTRS	LTRS	DC3	DC3	_(Underline)	

## HEXADECIMAL CONVERSION TABLE (CONTINUED)

HEX	BAUDOT		BCDIC		ASCII	EBCDIC
	LTRS	FIGS	UPPER	LOWER		
E0	Blank	Blank	-	-	` (Opening Single Quote)	/(Reverse Slash)
E1	E	3	J	j	a	
E2	LF	LF	K	k	b	S
E3	A	-	L	l	c	T
E4	Space	Space	M	m	d	U
E5	S	' or BELL	N	n	e	V
E6	l	8	O	o	f	W
E7	U	7	P	p	g	X
E8	CR	CR	Q	q	h	Y
E9	D	WRU or S	R	r	i	Z
EA	R	4			j	
EB	J	BELL or '	!	\$	k	
EC	N	,	DC4	DC4	l	
ED	F	!	CR	CR	m	_(Underline)
EE	C	:	BS	BS	n	
EF	K	(	DLE	DLE	o	
F0	T	5	+	&	p	0
F1	Z	+ or "	A	a	q	1
F2	L	)	B	b	r	2
F3	W	2	C	c	s	3
F4	H	#	D	d	t	4
F5	Y	6	E	e	u	5
F6	P	0	F	f	v	6
F7	Q	1	G	g	w	7
F8	O	9	H	h	x	8
F9	B	?	I	i	y	9
FA	G	&			z	
FB	FIGS	FIGS	.	.	{ (Opening Brace)	
FC	M	.	DC1	DC1	(Vertical Line)	
FD	X	/	HT	HT	} (Closing Brace)	
FE	V	= or ;	LOWER	LOWER	~ (Overline Tilde)	
FF	LTRS	LTRS	DEL	DEL	DEL (Delete/Rubout)	

## APPENDIX E SOFTWARE HISTORY

### E.1 SECTION SUMMARY

This appendix briefly lists several software revisions for the FIREBERD 6000, and the changes supported by each revision.

<b>Software Rev.:</b>	<b>Release Date:</b>	<b>Changes Incorporated:</b>
C	04/06/87	Add G.821 Performance results
D	12/21/87	Add support for 2M G.704 Interface (Model 30609) Add support for 64K G.703 Interface (Model 30608) Add additional error print events Add support for ISU 6000 Add support for European Jitter Options (6007 and 6008)
E	04/05/89	Add Long User Pattern (LUP) feature to support synchronous long user messages DS0A/B Interface (Model 30678) Add Auxiliary Function 46 for Asynchronous Timeout Modify graphics and RS-232 default settings to support TTC's PR-40A printer
F	11/01/89	Add support for ISDN S/T TE Interface (Model 41075)
G	11/05/90	Add support for FT1 Interface (Model 41440) Add support for DDS Local Loop Interface (Model 41131) Add support for RS-449/MIL Interface (Model 41421) Add support for IEEE-488.2 remote control ISDN S/T TE Interface (Model 41075) to support NTI DMS100 switch Requires RAM expansion to 64K and ROM expansion to 512K to support Rev. G software enhancements
H	12/19/91	Add support for DS3 Interface (Model 41945) Add support for 2M/n64 Interface (Model 41800) Add support for Access Interface (Model 41910) Enhance FT1 Interface (Model 41440) to support loop code response RECALL/STORE configurations can be named
J	12/02/92	Add support for High Speed Serial Interface (Model 42219) Add support for Combined Data Interface (Model 42522) Revise DDS DATA patterns (DDS-3, DDS-5, and DDS-6). Refer to Table E-1 for pattern compatibility for different software revision levels Add T1-DALY pattern Enhance DDS Interface (Model 41131) to respond to additional loop codes Enhance FT1 Interface (Model 41440) to: — support T1.403 Program Response Messages (PRM) Option 6009 — support transmitting V.54 loopbacks — support FT1 drop and insert
K	03/15/94	Add support for Frame Relay option (Option 6010) Enhanced High Speed Serial Interface (Model 42219) to support: High Sync Threshold Enhanced DS3 Interface (Model 41945) to support: High Sync Threshold Enhance Combined Data Interface (Model 42522) to support: X.21 Loop Codes

**Table E-1**  
**DDS Pattern Compatibility for Different Software Revisions**

Pattern/Software Rev.	Compatibility	
	Rev. H	Rev. J
DDS-3 Rev. H	DDS-3	Program LUP*
DDS-3 Rev. J	Program LUP*	DDS-3
DDS-5 Rev. H	DDS-5	DDS-6
DDS-5 Rev. J	DDS-6	DDS-5
DDS-6 Rev. H	DDS-6	DDS-5
DDS-6 Rev. J	DDS-5	DDS-6

\* Use LUP: Program 4C into a User pattern.



## APPENDIX F FRAME RELAY

### F.1 OVERVIEW

Frame relay is a packet-mode service with high throughput and low delay characteristics. Unlike other packet switching technologies, frame relay completely eliminates all processing at Layer 3 (Network Layer) of the OSI Reference Model and performs only a portion of the traditional Layer 2 (Data Link Layer). Since frame relay has no error correction capabilities, it must be implemented in relatively error-free networks to ensure high throughput.

The Frame Relay option is supported in FIREBERD 6000 equipped with Rev. K software and higher. The option allows you to perform Physical Layer analysis of the network by verifying the circuit is able to support frame relay operation.

The Frame Relay option provides the ability to collect basic protocol statistics about the frame relay circuit under test. These protocol statistics include:

- Frame Count
- Framed Octet Count
- Errored Frame Count
- Aborted Frame Count
- Frames with the FECN Bit Set
- Frames with the BECN Bit Set
- Frames with the DE Bit Set
- Average Utilization
- Maximum Utilization
- Average Throughput
- Maximum Throughput

These statistics can be collected on one specific DLCI or on the aggregate of all DLCIs.

With the Frame Relay option installed and the 12 FRAME RELAY auxiliary function enabled, the FIREBERD 6000 can turn up a frame relay link and then perform frame relay WAN protocol analysis up to 2048 kb/s (higher rates with data communication interfaces).

The Frame Relay option also allows the FIREBERD 6000 to generate frame relay loads with varying stress parameters. Frame relay parameters that can be varied include:

- Frame Size
- Throughput
- Transmission Pattern (Constant or Bursty)

The following interface modules are supported by the Frame Relay option.

Model:	Description:
INT232	Internal RS-232 Interface
40202	V.35/306 DTE/DCE Interface
40200	RS-449 (422/423) DTE/DCE Interface
42522	V.35/306/RS-449/X.21 DTE/DCE Interface
41400	RS-449/530/MIL Interface
30678/A	DDS DS0A/B Interface
41131/A/B	DDS Local Loop Interface
41440A	T1/FT1 Interface

## Frame Relay

Model:	Description:
40540	DS1/T1/D4/ESF/SLC-96 Interface
30608	CCITT G.703 64 kb/s Interface
30609	CCITT G.704 2048 kb/s Interface
41800	CCITT 2.048M/Nx64 kb/s Interface
40204	Lab (TTL) Interface

To monitor a link, the selected interface must be connected as a DTE or DCE with the transmitter disabled. The link being monitored can only be monitored in one direction (either DTE or DCE).

A special Y-cable (Part No. 43013-01) is required when using V.35 connections. This Y-cable disables the transmit functions during monitor mode and allows the user to select the direction in which frame relay traffic is to be monitored.

## F.2 INSTALLING THE FRAME RELAY OPTION

The Frame Relay option is a factory-installed option. Have the Frame Relay option installed in the FIREBERD 6000 at the time of purchase, or have the Frame Relay option installed as a factory retrofit. Retrofitting a FIREBERD 6000 requires one or more of the following assemblies to be replaced or upgraded:

- Data Generate & Receive board
- EPROM card (Rev. K or higher software)
- Processor board

## F.3 SELECTING THE FRAME RELAY OPTION

The following paragraphs describe the process for selecting the Frame Relay option and configuring the 12 FRAME RELAY auxiliary function to test frame relay circuits.

### F.3.1 Frame Relay Menu

Press the **MENU** switch until the AUXILIARY LED illuminates. With the AUXILIARY FUNCTIONS menu displayed, press the LIST softkey to view the available auxiliary functions. Press the FWD (forward) softkey until the 12 FRAME RELAY auxiliary function appears. Then press the SELECT softkey to display the Frame Relay top level menu as shown in Figure F-1.

As an alternate way of enabling the Frame Relay option (once the AUXILIARY LED illuminates), press the 1 and 2 keypad keys and press **ENTER** to select Auxiliary Function 12.

**NOTE:** When the Frame Relay option is enabled, BER analysis, pattern selection, and LUP are disabled. However, you can still perform other measurements (e.g., CRC errors, BPVs, Signal level, etc.).

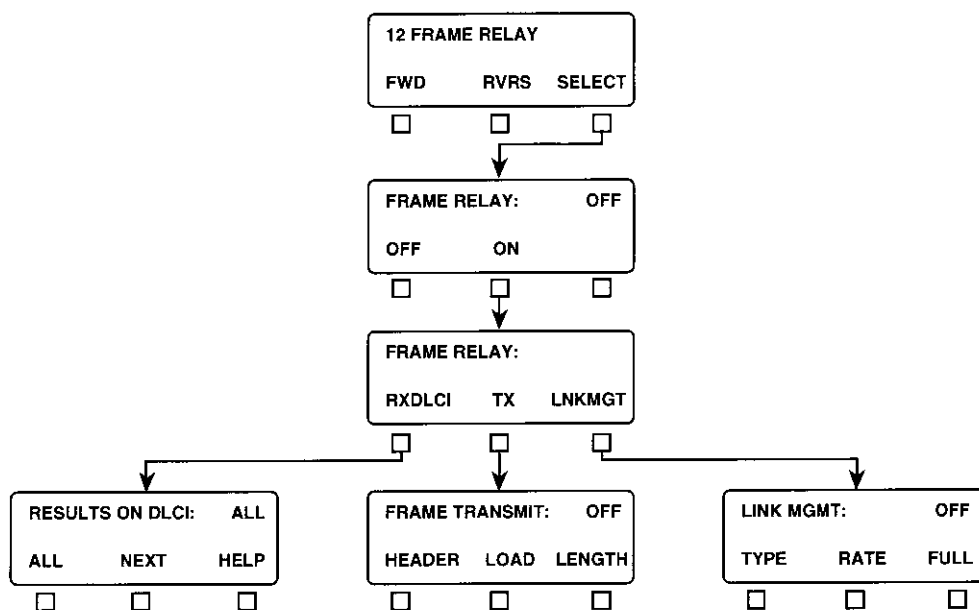

**Figure F-1**  
**Frame Relay Top Level Menus**

Setting the 12 FRAME RELAY auxiliary function to ON backlights the AUX FUNC IN USE label and displays the following menu selections for frame relay testing:

- RXDLCI — Results On DLCI menu
- TX — Frame Transmit menu
- LNKMGT — Link Management menu

### F.3.2 Results On DLCI Menu

Pressing the RXDLCI softkey displays the Results On DLCI menu, as shown in Figure F-2. The Results On DLCI menu allows you to specify either all DLCIs, one specific DLCI (0 to 1023), or the next highest DLCI to be monitored.

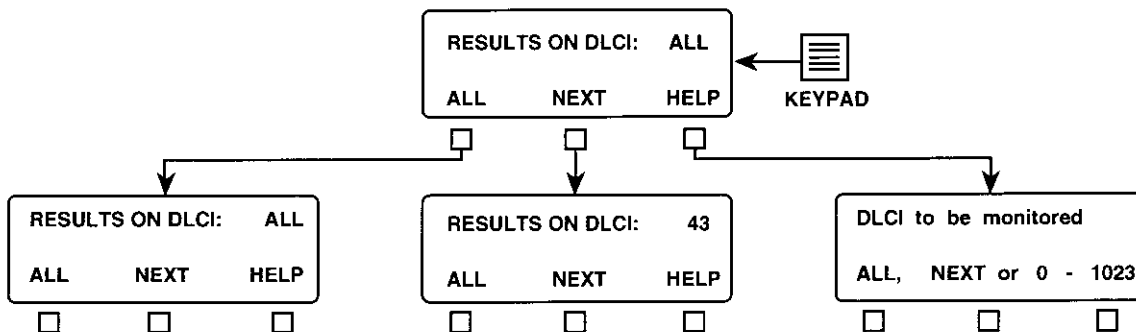

**Figure F-2**  
**Results On DLCI Menu**

## Frame Relay

The Results On DLCI menu softkeys perform the following functions:

**ALL** — press the softkey to select all DLCIs to be monitored.

**NEXT** — press the softkey to select the next highest DLCI to be monitored.

**HELP** — press the softkey to display the help information.

**Keypad (0 to 9)** — enter the specific DLCI (0 to 1023) to be monitored, then press **ENTER**. If you enter an invalid DLCI, the previously valid DLCI reappears.

The FIREBERD 6000 accumulates DLCIs from the Full Status Link Management frames supplied by the network and stores them in a table.

### F.3.3 Frame Transmit Menu

Pressing the TX softkey displays the Frame Transmit menu, as shown in Figure F-3. The Transmit Frame menu allows you to specify the destination PVC's DLCI and the status of the bits in the address field. The Transmit Frame menu is controlled through the Frame Load menu.

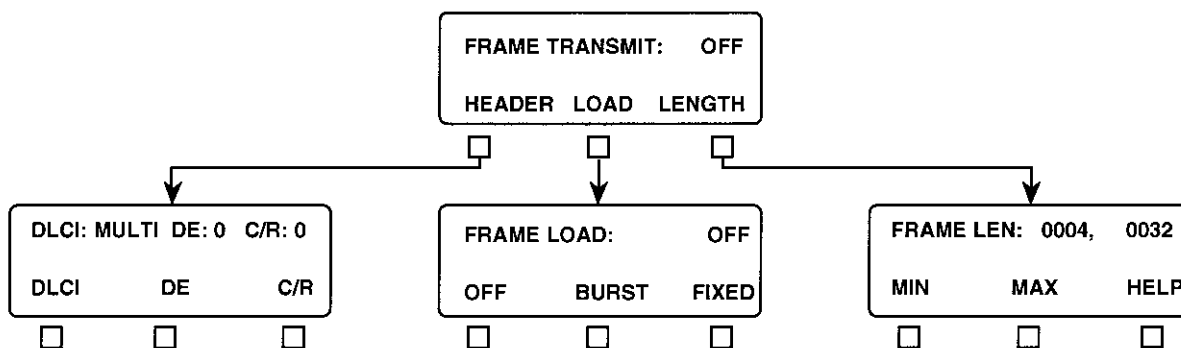
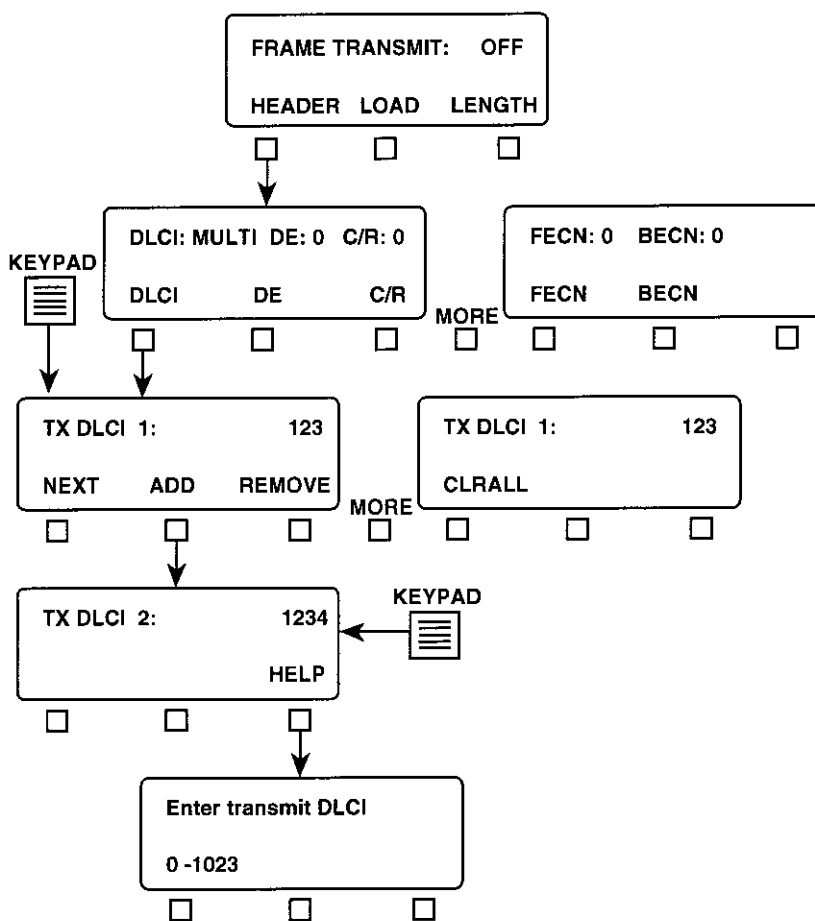

**Figure F-3**  
**Frame Transmit Menu**

The Frame Transmit menu softkeys perform the following functions:

#### HEADER Softkey

Press the HEADER softkey to display the Header menu, as shown in Figure F-4. The Header menu selects the DLCI (single or multiple) being transmitted and sets the value of the DE, C/R, FECN, and BECN bits.



**Figure F-4**  
**Header Menu**

The Header menu softkeys perform the following functions:

**DLCI** — press the softkey to display the TX DLCI menu. This allows single or multiple DLCIs to be transmitted across multiple frames. The TX DLCI menu softkeys perform the following functions:

**NEXT** — press the softkey to scroll through and display multiple transmit DLCIs. The softkey is only functional when more than one transmit DLCI is programmed.

**ADD** — press the softkey to add a new transmit DLCI (TX DLCI xx:, xx = 1 to 10). Enter the DLCI with the keypad.

**REMOVE** — press the softkey to delete the currently displayed transmit DLCI (TX DLCI xx:, xx = 1 to 10). TX DLCI 1 is the default TX DLCI and cannot be deleted.

**CLRALL** — press the softkey to clear all transmit DLCIs, except for TX DLCI 1.

**HELP** — press the softkey to display the help information.

**Keypad (0 to 9)** — enter the specific DLCI (0 to 1023) to be transmitted to change the currently displayed transmit DLCI, then press **ENTER**. If you enter an invalid DLCI, the previously valid DLCI reappears.

## Frame Relay

**DE** — press the softkey to toggle the bit value to its opposite condition (0 or 1).

**C/R** — press the softkey to toggle the bit value to its opposite condition (0 or 1).

**FECN** — press the softkey to toggle the bit value to its opposite condition (0 or 1).

**BECN** — press the softkey to toggle the bit value to its opposite condition (0 or 1).

## LOAD Softkey

Press the LOAD softkey to display the Frame Load menu, as shown in Figure F-5. The Frame Load menu allows you to specify the transmit channel loading type.

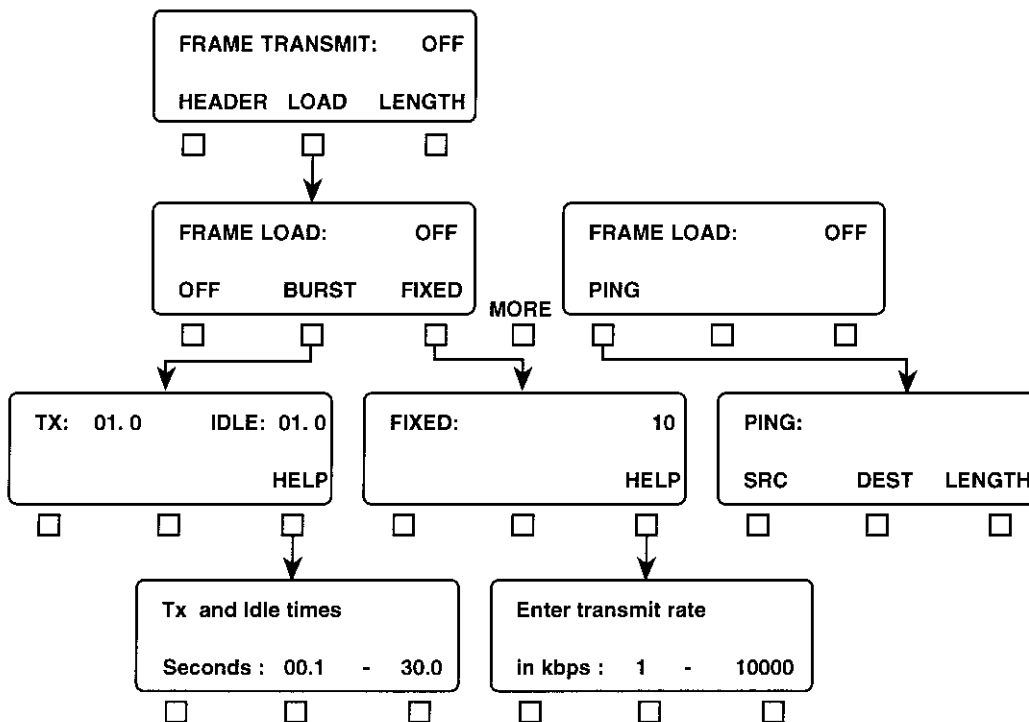

**Figure F-5**  
**Frame Load Menu**

The Frame Load menu softkeys perform the following functions:

**OFF** — press the softkey to stop generating the frame load (except link management frames, if configured to do so).

**BURST** — allows you to specify the frame load burst transmit (TX) and idle (IDLE) times. Note that during the TX time, 100% utilization load is generated and 0% utilization is transmitted during the idle time.

**Keypad (0 to 9)** — enter the frame load burst transmit (TX) and idle (IDLE) times from 00.1 to 30.0 seconds, then press **ENTER**. If you enter an invalid time, the previously valid time reappears.

**HELP** — press the softkey to display the help information.

**FIXED** — allows you to specify a fixed information rate for transmission. The fixed rate is calculated over a 1-second interval (e.g., “10” transmits 10,000 frame bits over the line whether it is a T1 rate, 56k, etc.)

**Keypad (0 to 9)** — enter the frame load transmission rate from 1 to 10,000 kb/s, then press **ENTER**. If you enter an invalid rate, the previously valid rate reappears.

**HELP** — press the softkey to display the help information.

**PING** — allows you to specify source, destination, encapsulation method, and IP datagram length, as shown in Figure F-6. This function enables in-service connectivity testing and round trip delay measurements to be performed between IP configured frame relay routers and the FIREBERD 6000 or between FIREBERD 6000s. The FIREBERD 6000 can PING an IP router or another FIREBERD 6000. An IP router can also PING a FIREBERD 6000 (the FIREBERD 6000 supplies IP echo reply). IP PING frames are sent in TX DLCI 1 only, even when multiple transmit DLCIs are defined. Changing any ping parameter causes a test restart. The PING menu softkeys perform the following functions:

**SRC** — enter the IP source address of the ping-transmitting unit with the keypad (0 to 9), then press **ENTER**. The range for each address field is 000 to 255. If you enter an invalid address, the previously valid address reappears.

**DEST** — enter the IP destination address of the echo-reply unit with the keypad (0 to 9), then press **ENTER**. The range for each address field is 000 to 255. If you enter an invalid address, the previously valid address reappears. The echo-reply unit source address must match the ping-transmitting unit destination address.

**LENGTH** — enter the IP packet length with the keypad (0 to 9), then press **ENTER**. The packet length controls the ping frame length which is padded with the “Quick brown fox...” message. The range for ping frame length is 34 to 2000. If you enter an invalid length, the previously valid length reappears.

**ENCAP** — select one of the following encapsulation formats:

**NONE** — disables encapsulation.

**NLPID** — enables NLPID (Network Layer Protocol Identification) encapsulation according to RFC 1490.

**HELP** — press the softkey to display the help information.

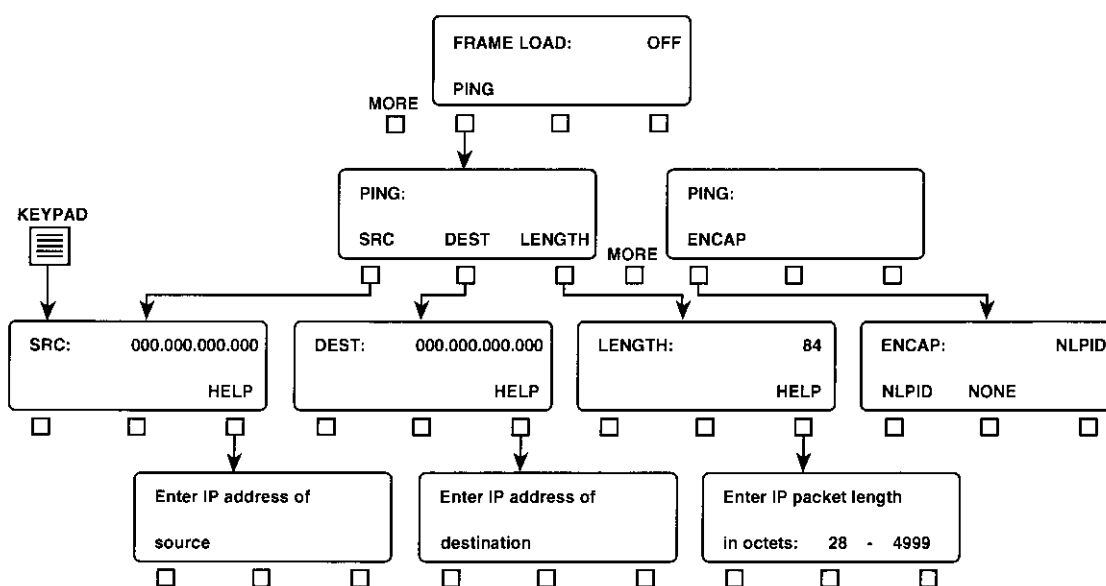
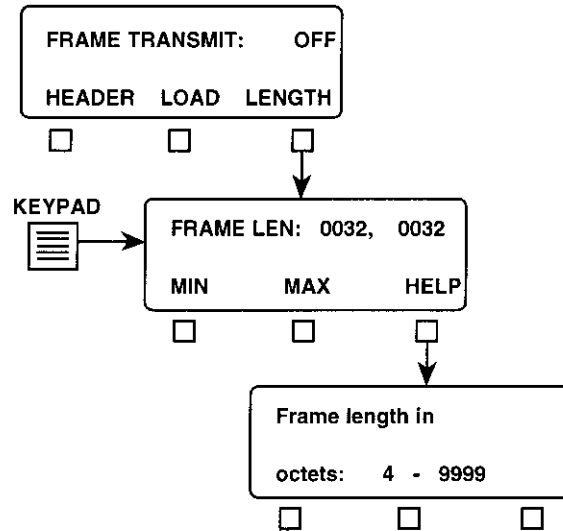

Figure F-6  
PING Menu

### LENGTH Softkey

Press the LENGTH softkey to display the Frame Length menu, as shown in Figure F-7. The Frame Length menu allows you to specify the minimum (4) and maximum (9999) frame length being transmitted. The frame length includes the header, user data field, and the FCS (e.g., everything between the flags).



**Figure F-7**  
**Frame Length Menu**

The Frame Length menu softkeys perform the following functions:

**MIN** — press the softkey to move the cursor under the most significant digit for the minimum frame length field (on the left). Enter the minimum information frame length (in octets from 4 to 9999) by using the keypad (0 to 9), then press **ENTER**. If you enter an invalid frame length, the previously valid frame length reappears.

**MAX** — press the softkey to move the cursor under the most significant digit for the maximum frame length field (on the right). Enter the maximum information frame length (in octets from 4 to 9999) by using the keypad (0 to 9), then press **ENTER**. If you enter an invalid frame length, the previously valid frame length reappears.

**HELP** — press the softkey to display the help information.

**NOTE:** If you set the MIN value greater than the MAX value or set MAX to a value less than MIN, pressing **ENTER** automatically sets the MAX value equal to the MIN value setting. To transmit frames of equal length, set the MIN value equal to the MAX value.

### F.3.4 Link Management Menu

Pressing the LNKMGMT softkey displays the Link Management menu, as shown in Figure F-8. The Link Management menu allows you to specify the link management type, poll status rate, and duration.



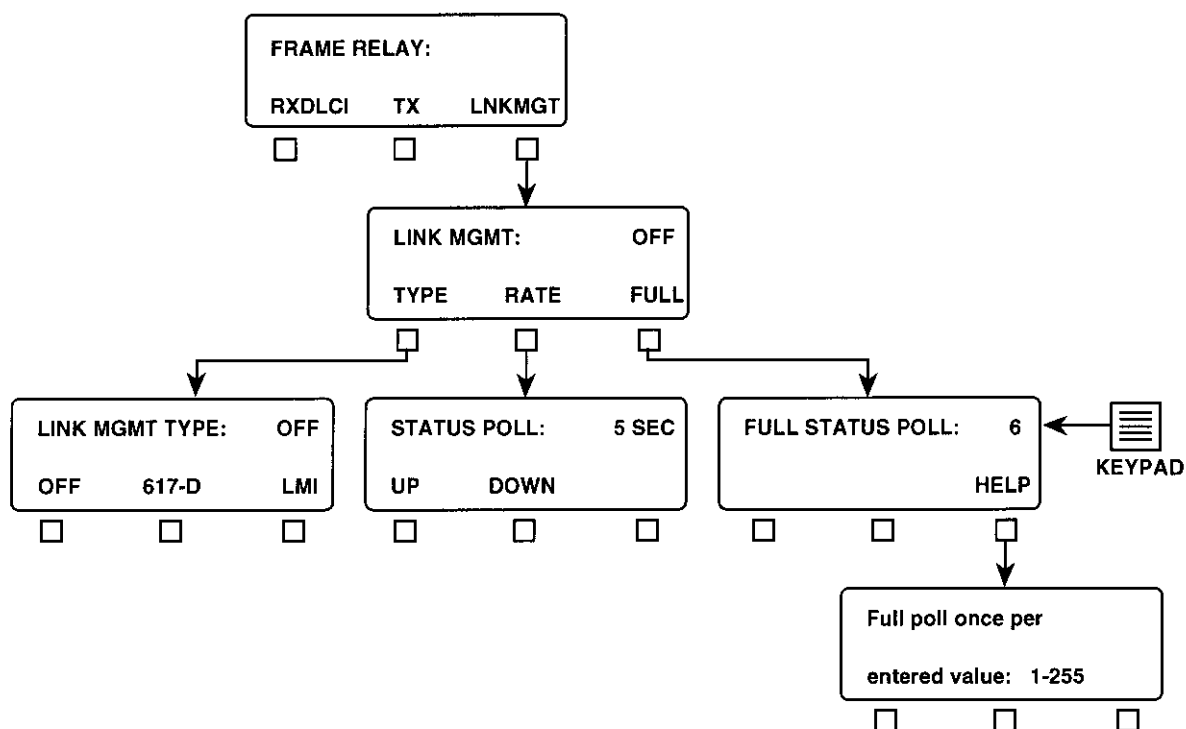

**Figure F-8**  
**Link Management Menu**

The Link Management menu softkeys perform the following functions:

**TYPE** — press the softkey to display the Link Management Type menu. The Link Management Type menu allows you to select the type of link management to be used. The Link Management Type menu softkeys perform the following functions:

**OFF** — no link management is selected (Unsupported).

**617-D** — selects the ANSI T1.617 Annex D link management.

**LMI** — selects the frame relay consortium local management interface.

**RATE** — press the softkey to display the Status Poll menu. The Status Poll menu displays the time interval between “STATUS ENQUIRY” polls transmitted by the FIREBERD 6000 to the network. The Status Poll menu softkeys perform the following functions:

**UP** — press the softkey to increment the status poll interval from 5 to 30 seconds in 5-second steps.

**DOWN** — press the softkey to decrement the status poll interval from 30 to 5 seconds in 5-second steps.

**FULL** — press the softkey to display the Full Status Poll menu. The displayed value indicates the interval between full status enquiry polls (measured in the number of status polls). Setting this menu to 5 and the Status Poll menu rate to 10, causes a full status poll to be transmitted every 50 seconds.

**Keypad (0 to 9)** — enter the full status enquiry poll interval from 1 to 255, then press **ENTER**. If you enter an invalid time, the previously valid time reappears.

**HELP** — press the softkey to display the help information.

## **Frame Relay**

### **F.3.5 Frame Relay Status Indicators**

The PATTERN SYNC LED indicates valid frame relay frames (on any DLCI) are being received. If no valid frames are received for 31 seconds then a synchronization loss is declared.

When the Frame Relay option is enabled, the BER analysis capability of the FIREBERD 6000 is not available when performing frame relay analysis. This means that pattern-related results (e.g., Bit Errors, BER, etc.) are not available when the Frame Relay option is active.

All other indicators and switches are based on the current interface selected.

## **F.4 AVAILABLE FRAME RELAY RESULTS**

The following ERROR and PERFORMANCE category results are provided when the Frame Relay option is enabled.

### **F.4.1 ERROR Category Results**

The following test results appear in the ERROR Category.

**TX PING** — number of ping packets/frames transmitted by the FIREBERD 6000. The result increments only when the transmit frame load is set to PING.

**ECHO PNG** — number of successful echo replies transmitted by the FIREBERD 6000. The destination address within the arriving ping packet must match the source address of the unit transmitting the echo reply. The destination address of the unit transmitting an echo reply can be blank or incorrect, it is irrelevant. When the 12 FRAME RELAY auxiliary function is enabled, the result is incremented in any mode.

**LOST PNG** — number of ping packets that were not echoed back to the FIREBERD 6000; including out of order echo reply packets and corrupted echo reply packets. The result is not used in delay calculations. The result increments only when the transmit frame load is set to PING.

**FRM CNT** — a count of the total number of frame relay frames detected (including errored and aborted frames). This result can be calculated across all DLCIs or for one specific DLCI.

**FRM OCTS** — a count of the total number of octets received in valid frame relay frames. This result can be calculated across all DLCIs or for one specific DLCI.

**NOTE:** The LMI ERRS and LMI TMOS results are only available when the Link Management Type is set to LMI or 617-D.

**FRM RATE** — the average number of frames received since the start of the test.

**AVG FRM** — the average frame size calculated as the number of FRM OCTS divided by the FRM CNT number. This result can be calculated across all DLCIs or for one specific DLCI.

**FCS ERRS** — a count of the invalid frame relay frames received with FCS errors. This result is calculated across all DLCIs. The number of errored frames incrementing indicates that there is a Physical Layer impairment on the monitored link.

**ABRT FRM** — a count of the aborted frame relay frames detected (excluding out of frame aborts). This result is calculated across all DLCIs. An aborted frame indicates that frame has become all 1s and that the link is dead or the switch on the other end stopped a frame in the middle of its transmission.

**SHRT FRM** — a count of the valid frames that are less than 5 bytes long, excluding the opening flag. This result is calculated across all DLCIs. The number of short frames incrementing indicates a network equipment fault.

**FECN FRM** — a count of valid frames with the FECN bit set (e.g., 1). This result can be calculated across all DLCIs or for one specific DLCI. This result incrementing indicates that the network is detecting congestion along the PVC at the receiving DLCI. Reducing the throughput of transmission is recommended.

**BECN FRM** — a count of valid frames with the Backward Explicit Congestion Notification (BECN) bit set (e.g., 1). This result can be calculated across all DLCIs or for one specific DLCI. When this result is incrementing, it indicates that frames transmitted on the PVC, for which BECN is set, are either causing or encountering congestion. Reducing the transmitted frame load should help to alleviate the condition.

**DE FRM** — a count of valid frames with the DE bit set (e.g., 1). This result can be calculated across all DLCIs or for one specific DLCI. When this result is incrementing, it indicates that received frames are being marked as “discard eligible”. This occurs because: 1) The far-end device is indicating that the frames can be discarded, or 2) The network is receiving frames from the far-end device at a rate that exceeds the committed information rate.

**LOST FRM** — a count of FIREBERD 6000 test frames that appear to have been lost by the network, based on gaps in the test frame’s sequence number. This result can only be calculated for one specific DLCI. This result increments to indicate that frames are being dropped from the network. Frames are dropped by the network when the frame is errored (has an invalid FCS) or is discarded because of congestion or over-utilization. The result does not increment when transmitting on more than one DLCI.

**LMI MSGS** — the total number of LMI messages received back from the switch since the start of the test. An incrementing count for this result indicates a “heartbeat”.

**LMI ERRS** — the total number of LMI errors detected. LMI errors indicate that the receive sequence number is not equal to the last transmitted send sequence number. This result incrementing indicates that the link management handshaking is not operating correctly.

**LMI TMOS** — the number of LMI timeouts. Indicates nonreceipt of a STATUS message within a polling interval after a STATUS ENQUIRY has been sent. This result incrementing indicates that the link from your FIREBERD 6000 to the network switch is down, that the link from the switch to you is down, or that the switch is down.

**PVC STAT** — the current status of the selected DLCI or the aggregate channel. This result is only available when one specific DLCI is analyzed. This is the status that the switch is reporting. The PVC STAT result can have the following possible values for a single DLCI or for all DLCIs.

Result Value:	Single DLCI Analysis:	All DLCI Analysis:
“ “	DLCI is undefined	No DLCIs are defined
INACTIVE	DLCI is inactive	All DLCIs are inactive
NEW	DLCI was just added	One or more DLCIs were just added
DELETED	DLCI was just deleted	One or more DLCIs were just deleted
RNR	DLCI status is RNR	One or more DLCIs status is RNR
ACTIVE	DLCI is active	One or more DLCIs are active

#### F.4.2 PERFORMANCE Category Results

The following test results appear in the PERFORMANCE Category.

**MIN PING** — minimum round trip delay, in milliseconds, since the beginning of the test based on the time difference between a transmitted ping and a successfully received echo reply. Resolution is 100  $\mu$ s. The result is only updated when the transmit frame load is set to PING.

## **Frame Relay**

**MAX PING**— maximum round trip delay, in milliseconds, since the beginning of the test based on the time difference between a transmitted ping and a successfully received echo reply. Resolution is 100  $\mu$ s. The result is only updated when the transmit frame load is set to PING.

**AVG PING**— average round trip delay, in milliseconds, since the beginning of the test based on the time difference between a transmitted ping and a successfully received echo reply. Resolution is 100  $\mu$ s. The result is only updated when the transmit frame load is set to PING.

**AVG%UTIL**— the average percentage of link utilization on the received channel since the start of the test calculated as the number of FRM OCTS divided by the total number of octets received. This result can be calculated across all DLCIs or for one specific DLCI.

**MAX%UTIL**— the maximum percentage of link utilization on the received channel in any one second since the start of the test. This result can be calculated across all DLCIs or for one specific DLCI.

**AVG TPUT**— the average received throughput since the start of the test, calculated as total received UDF bits divided by the total seconds. This result can be calculated across all DLCIs or for one specific DLCI. This result can be used to estimate the CIR (committed information rate).

**MAX TPUT**— the maximum received throughput during any one second since the start of the test. This result can be calculated across all DLCIs or for one specific DLCI.

### **F.4.3 Error Print Results**

The FCS ERRS and ABRT FRM results are able to generate error prints.

### **F.4.4 Delta Print Results**

The following results can appear in delta prints:

- ABRT FRM
- AVG%UTIL
- BECN FRM
- DE FRM
- FCS ERRS
- FECN FRM
- FRM CNT
- FRM OCTS
- LOST FRM
- MAX%UTIL

### **F.4.5 Results Prints**

When the Frame Relay option is selected, the standard results print additionally prints the following results:

- ABRT FRM
- AVG TPUT
- AVG%UTIL
- FCS ERRS
- FRM CNT
- FRM OCTS
- LOST FRM

All results are displayed for long result prints.

### F.4.6 Histogram Results

The following are results that can be selected to generate a histogram print:

ABRT FRM  
 AVG TPUT  
 BECN FRM  
 DE FRM  
 FCS ERRS  
 FECN FRM  
 FRM CNT  
 FRM OCTS  
 LOST FRM  
 AVG%UTIL  
 MAX%UTIL

## F.5 LINK LAYER ANALYSIS

Link Layer analysis is performed in a monitoring or link terminating configuration. This allows statistics on the frame relay to be collected. The Link Layer analysis capability enables you to:

- Receive and analyze frames with up to 100% line utilization with minimum frame size (5 octets) at 2.048 Mb/s, irrespective of any other function being performed.
- Accumulate the following Link Layer statistics computed across the entire bandwidth, or for a single DLCI that you specify:

Total Frame Octets Received  
 Total Frames Received  
 Average Frame Size  
 Frames with the FECN Bit Set  
 Frames with the BECN Bit Set  
 Frames with the DE Bit Set  
 Errored Frames  
 Aborted Frames  
 Short Frames  
 Average Throughput (in kb/s)  
 Maximum Throughput (kb/s)  
 Average % Utilization  
 Maximum % Utilization

## F.6 LOAD GENERATION AND ANALYSIS

When used in a link terminating configuration, the Frame Relay option can transmit FIREBERD 6000 test frames according to load parameters that you specify.

## **Frame Relay**

This ability to generate test frames meets or exceeds the following requirements.

- Generates frames at 100% utilization with a User Data Field (UDF) of 0 octets at 2.048 Mb/s, irrespective of any other function being performed.
- Generates fixed length frames with a total length of between 4 and 9999 octets; or
- Generates random length frames within a minimum and maximum length, which you specify (4 to 9999 octets). Note that flags are not included in the length specified.
- Generates frames at a fixed utilization between 1 and 10,000, in 1 kb/s increments with the load distributed over the full link capacity; or
- Generates frames with a bursty utilization, at 100% utilization for 00.1 to 30.0 seconds, then at a 0% utilization (idle) for 00.1 to 30.0 seconds.
- Generates frames for one or multiple DLCIs (1 to 10), allowing you to control the state of the FECN, BECN, DE, and/or C/R bits.
- Generated frames of sufficient length to conform with RFC 1490, with the Network Layer Protocol Identifier (NPID) and Subnetwork Access Protocol (SNAP) header ID set to identify the frame as a FIREBERD 6000 test frame. The user data in generated frames consists of a sequential count (from 0 to 65536), and the remainder of the data is a fixed pattern. Generated frames that do not have a length sufficient to conform with RFC 1490 will be a truncated form of the standard test frame. Note that the Frame Relay option supports AUX 04 (Single Transmit Mode).
- Received FIREBERD 6000 test frames have their sequence number analyzed for lost frames (LOST FRM), in addition to the standard LinkLayer analysis described previously. If analysis is configured for a single DLCI, then only test frames with that DLCI are analyzed.

## **F.7 LMI ANALYSIS AND EMULATION**

The Frame Relay option decodes Local Management Interface (LMI) messages to provide PVC and link status information in the form of LMI results. LMI messages are available whether in monitoring or terminating configurations.

In terminating configurations, LMI emulation can be enabled to actively poll the network for status information. The LMI analysis/emulation capability meets or exceeds the following requirements:

- Supports either ANSI T1.617 Annex D or the Frame Relay Forum scheme (optional extensions are not presently supported).
- Provides a user-selectable heartbeat polling (from 5 to 30 seconds), in 5-second increments.
- Provides a user-selectable full status polling interval (from 1 to 255 poll cycles).
- Provides the following LMI-derived results:

- LMI MSGS
- LMI ERRS
- LMI TMOS
- PVC STAT

## F.8 REMOTE CONTROL COMMANDS

Remote control commands used to control the Frame Relay option are described in the following paragraphs. The FIREBERD 6000 adheres to the IEEE-488.2 remote control syntax.

AUX:FRAME\_RELAY OFF

Turns off the Frame Relay option.

AUX:FRAME\_RELAY ON

Turns on the Frame Relay option.

AUX:FRAME\_RELAY?

Requests the status of the Frame Relay option.

AUX:FRAME\_RELAY:BURST\_TIME xxx

Sets the burst time in tenths of a second (where xxx = 001 to 999).

AUX:FRAME\_RELAY:BURST\_TIME?

Requests the current burst time selection.

AUX:FRAME\_RELAY:DLCI\_MON xxxx

Selects the DLCI to be monitored (where xxxx = All, NEXT, or 0 to 1023).

AUX:FRAME\_RELAY:DLCI\_MON?

Requests the DLCI being monitored.

AUX:FRAME\_RELAY:FIXED\_RATE xxxxx

Sets the fixed rate, in kb/s (where xxxxx = 1 to 10000).

AUX:FRAME\_RELAY:FIXED\_RATE?

Requests the fixed rate selection.

AUX:FRAME\_RELAY:HEADER:BE CN [OFF|ON]

Sets the BECN bit (where OFF = 0 and ON = 1).

AUX:FRAME\_RELAY:HEADER:BE CN?

Requests the BECN bit value.

AUX:FRAME\_RELAY:HEADER:CR [OFF|ON]

Sets the C/R bit (where OFF = 0 and ON = 1).

AUX:FRAME\_RELAY:HEADER:CR?

Requests the C/R bit value.

AUX:FRAME\_RELAY:HEADER:DE [OFF|ON]

Sets the DE bit (where OFF = 0 and ON = 1).

AUX:FRAME\_RELAY:HEADER:DE?

Requests the DE bit value.

AUX:FRAME\_RELAY:HEADER:DL CI nn, xxxx

Sets the DLCI header (where nn = 1 to 10 and xxxx = 0 to 1023).

AUX:FRAME\_RELAY:HEADER:DL CI? nn

Requests the DLCI header number.

## **Frame Relay**

AUX:FRAME\_RELAY:HEADER:DLCI\_ADD xx

Adds a new transmitted DLCI (where xx = 1 to 10).

AUX:FRAME\_RELAY:HEADER:DLCI\_num?

Requests number of DLCI entries.

AUX:FRAME\_RELAY:HEADER:DLCI\_REMOVE nn

Removes DLCI entry (where nn = 1 to 10).

AUX:FRAME\_RELAY:HEADER:FECN [OFF|ON]

Sets the FECN bit (where OFF = 0 and ON = 1).

AUX:FRAME\_RELAY:HEADER:FECN?

Requests the FECN bit value.

AUX:FRAME\_RELAY:IDLE\_TIME xxx

Sets the idle time, in tenths of a second (where xxx = 001 to 999).

AUX:FRAME\_RELAY:IDLE\_TIME?

Requests the current idle time selection.

AUX:FRAME\_RELAY:LNKMGT [OFF|617-D|LMI]

Sets the link management type (where OFF = none, 617-D = ANSI T1.617 Annex D, and LMI = Frame Relay Forum).

AUX:FRAME\_RELAY:LNKMGT?

Requests the frame relay link management type.

AUX:FRAME\_RELAY:LNKMGT:FULL xxx

Sets the number of full LMI status polls that are sent.

AUX:FRAME\_RELAY:LNKMGT:FULL?

Requests the number of full LMI status polls that are to be sent.

AUX:FRAME\_RELAY:LNKMGT:POLL xx

Sets the frequency (how often) LMIs are sent, in seconds (where xx = 5 to 30, dividible by 5).

AUX:FRAME\_RELAY:LNKMGT:POLL?

Requests the LMI poll interval time.

AUX:FRAME\_RELAY:MAX\_LENGTH xxxx

Sets the maximum frame relay length (where xxxx = 4 to 9999).

AUX:FRAME\_RELAY:MAX\_LENGTH?

Requests the maximum frame relay length selection.

AUX:FRAME\_RELAY:MIN\_LENGTH xxxx

Sets the minimum frame relay length (where xxxx = 4 to 9999).

AUX:FRAME\_RELAY:MIN\_LENGTH?

Requests the minimum frame relay length selection.

AUX:FRAME\_RELAY:TX\_LOAD [OFF|BURST|FIXED|PING]

Sets the type of transmit load (where OFF = no transmission, BURST = transmission for the burst time, FIXED = the set rate (in kb/s) up to 10 Mb/s, and PING = enable PING function).

AUX:FRAME\_RELAY:TX\_LOAD?

Requests the TX load selection.



AUX:FRAME\_RELAY:TX\_LOAD:PING\_DEST xxx.xxx.xxx.xxx

Sets the IP destination address (where xxx = 000 to 255).

AUX:FRAME\_RELAY:TX\_LOAD:PING\_DEST?

Requests the IP destination address.

AUX:FRAME\_RELAY:TX\_LOAD:PING\_ENCAP [NONE|NLPID]

Sets the encapsulation format (where NONE = off and NLPID = Network Layer Protocol Identification encapsulation enabled).

AUX:FRAME\_RELAY:TX\_LOAD:PING\_ENCAP?

Requests the encapsulation format.

AUX:FRAME\_RELAY:TX\_LOAD:PING\_LENGTH nnnn

Sets the IP packet length (where nnnn = 28 to 4999).

AUX:FRAME\_RELAY:TX\_LOAD:PING\_LENGTH?

Requests the IP packet length.

AUX:FRAME\_RELAY:TX\_LOAD:PING\_SRC xxx.xxx.xxx.xxx

Sets the IP source address (where xxx = 000 to 255).

AUX:FRAME\_RELAY:TX\_LOAD:PING\_SRC?

Requests the IP source address.

## F.9 FRAME RELAY TECHNOLOGY

Frame relay is a protocol that is used to provide access to the public network. The FIREBERD 6000 tests the frame relay protocol at any User Network Interface (UNI) access point. In other words, frame relay is tested between user devices (i.e., routers, bridges, or host machines) and network equipment (i.e., switching nodes). User devices are commonly referred to as DTE (Data Terminal Equipment), while network equipment that interfaces with the DTE is referred to as DCE (Data Circuit-terminating Equipment).

Frame relay is a streamlined protocol since it does not provide for error correction. It provides higher performance and greater efficiency, allowing greater throughput and bandwidth on demand. Frame relay accomplishes this by statistically multiplexing many logical data conversations (called virtual circuits) over a single physical transmission link. This statistical multiplexing provides a more flexible and efficient utilization of available bandwidth.

Due to recent improvements in digital transmission technology, wide area networks have produced transmission links with BERs (Bit Error Rates) of 1 in 100,000,000 bits. As a result of low BERs, Data Link Layer (Layer 2 of the ISO Reference Model) protocols can forego the link-by-link error correction algorithms, leaving this function to be performed by higher layers of protocol when necessary. This allows for greater performance and efficiency without sacrificing data integrity.

Frame relay was designed with this approach in mind. Frame relay provides a FCS (Frame Check Sequence) for the purpose of detecting corrupted data bits, but does not provide any means for correcting errors. Corrupted frames are simply discarded as they are encountered.

Due to the widespread use of higher layer protocols used to perform flow control, frame relay does not include explicit flow control procedures, since doing so would be redundant with those in higher layers. However, frame relay does provide a very simple congestion notification mechanism to allow a network to inform a user device (DTE) when the network has reached a congested state.

The frame relay frame is shown in Figure F-9 and is delimited by flags at the beginning (opening flag) and ending of the frame (closing flag). All frame relay frames start and end with the following 8-bit flag sequence: one 0 bit followed by six consecutive 1 bits and one 0 bit.

## Frame Relay

8	7	6	5	4	3	2	1
0	1	1	1	1	1	1	0
DLCI (high order bits)						C/R	EA
DLCI (high order bits)				FECN	BECN	DE	C/R
Information Field							
FCS							
FCS (cont'd)							
0	1	1	1	1	1	1	0

**Figure F-9**  
**Frame Relay Frame Format**

The frame relay frame is transmitted from left to right and the octets are transmitted from top to bottom and is described as follows:

**DLCI** — Data Link Connection Identifier Address field (the MSB is Bit 8 in Octet 2 and the LSB is Bit 5 in Octet 3). The DLCI values available for use are determined by the service being provided.

**C/R** — Command/Response Indicator. The C/R bit, when implemented, is used (by the end user, not the network) to indicate whether the frame is a command or a response. Frame relay does not make use of this bit.

**FECN** — Forward Explicit Congestion Notification. The FECN bit is set by the network to notify the user that congestion avoidance procedures should be initiated, where applicable, for traffic in the direction of the frame carrying the FECN notification. The FECN bit is set to 1 in the direction of the congestion to notify the user that the network is congested. This bit is set to 1 to indicate to the receiving end-system that the frames it is receiving have encountered congested resources.

**BECN** — Backward Explicit Congestion Notification. The BECN bit is set by the network to notify the user that congestion avoidance procedures should be initiated, where applicable, for traffic in the opposite direction of the frame carrying the BECN notification. The BECN bit is set to 1 in the opposite direction of the congestion to notify the user that the network is congested. This bit is set to 1 to indicate to the receiving end-system that the frames it is transmitting have encountered congested resources.

**EA** — Address Field Extension Bit Indicator. The EA bit is the first bit of each octet (byte) of the address field. When the EA bit is set to 0, it indicates that another octet is following in the address field. When the EA bit is set to 1, it indicates that it is the last octet and that no other octet is following in the address field. The FIREBERD 6000 only supports 2 octet addresses.

**DE** — Discard Eligibility. The DE bit is set to 1 to indicate that this frame is eligible to be discarded instead of other frames when congestion is encountered. The network may discard a frame that has the DE bit set to 1 if the frame is routed across a point where congestion is occurring. However, if at the point where congestion is occurring and all frames with the DE bit set to 1 have been dropped and congestion still exists, the network will begin dropping frames that have their DE bit set to 0.

**Information Field** — User data. The information field contains the data that the user is transmitting. The maximum length of this field is determined by the service provider.

**FCS** — Frame Check Sequence. The FCS field is used to determine whether the address field and information field contain any errors. Frames with an invalid FCS are discarded by the network. The FCS is considered to be invalid when the FCS calculated on the received frame does not match the FCS within the frame.

**Frame Abort** — A frame with 7 or more consecutive 1 bits is a frame abort sequence. Upon receipt of the frame abort sequence, the network discards the frame. All received data following the Abort Frame is discarded, up to the next valid flag is received.

## F.10 FRAME RELAY TESTING

You can use the Frame Relay option to:

- Perform complete physical layer testing of the local loop (or between nodes).
- Verify proper Link Management operation.
- Route frames across the network across a specific DLCI.
- Stress the network by transmitting frames (and monitoring at the receiving end).
- Non-intrusively monitor frame relay traffic on live data.
- Ping in-service routers and measure round trip delay.

Testing is considered to be intrusive (interrupting data) or non-intrusive (monitoring live data). Since intrusive testing is performed basically the same way as BER Physical Layer testing, only non-intrusive testing is discussed in the following paragraphs.

### F.10.1 In-Service Monitoring

You can perform non-intrusive monitoring of live data by using the V.35 "Y" cable and the RS449/V.35/306/X.21 interface (Model 42522) or the V.35/306 DTE/DCE interface (Model 40202).

**NOTE:** When performing tests with the V.35 "Y" cable (Part No. 43013-01), the maximum data rate recommended is 2 Mb/s.

When monitoring a T1 circuit, you can also use a bridging cable, a DSX MON jack, or any available monitor access point. The following steps describe the procedure for performing in-service monitoring.

1. With the FIREBERD 6000 power turned OFF, insert the T1/FT1 interface in the vacant interface slot on the rear panel.
2. Turn ON the FIREBERD 6000 power.
3. Press the **MENU** switch until the AUXILIARY LED illuminates.
4. Press the 1 and 2 keys on the keypad, then press **ENTER** to display the 12 FRAME RELAY auxiliary function. Be sure ON appears. If not, press the softkey below ON to enable the Frame Relay option.
5. Configure the link management for the frame relay circuit being monitored by pressing the LNKMGMT softkey to display the selected link management. Be sure the displayed link management matches the link management for the frame relay circuit being monitored.
6. As a precaution, verify that no frames are being transmitted by pressing the LOAD softkey. Be sure that OFF is displayed for the FRAME LOAD menu. If it isn't, press the OFF softkey. (This is done since we are only monitoring data.)
7. Connect the bantam cable from the RX interface connector to the DSX MON jack to monitor data on the circuit you desire.
8. Press the **RESTART** key to clear any result values and begin monitoring live data.







# INDEX

## A

- access 1-1
- accessories 5-2
- ADDRESSABLE mode 3-1, 4-5
- ALBO 2-38
- analysis 1-2
- analysis results 2-1
- ASCII 3-1
- asynchronous 1-13, 1-14, 4-1
- Asynchronous operation 2-94
- Asynchronous timing 2-89, 2-94
- auto-baud 4-4
- automatic printouts 3-2
- autopolarity 2-88
- AUX FUNC IN USE 2-31, 2-68, 2-102
- auxiliary function 1-13, 1-14, 3-2
- auxiliary function 11 3-5, 3-13
- Auxiliary Function 12 F-2
- auxiliary function 35 3-6
- auxiliary function 36 3-10
- auxiliary function 37 3-13
- Available time C-2, C-3, C-4

## B

- BAUD 4-1, 4-2
- baud rates 3-1
- BECN Bit F-18
- BREAKOUT BOXES 5-11

## C

- C/R Bit F-18
- Cable Interface Adaptor 1-15, 5-5
- CABLES 5-11
- category
  - AUXILIARY 3-2, 3-5
- character
  - command 3-1
  - prompt 3-1
- characters 4-12
- CLK INV 2-32
- clock loss 2-89, 2-92
- command syntax 4-12
- COMMANDS 4-10, 4-12
  - AUXILIARY 4-12, 4-13
  - COMMON 4-12
  - CONFIGURATION 4-12
  - INTERFACE 4-12

- JITTER 4-12
- PRINT 4-12
- REMOTE CONTROL 4-12
- RESULT 4-12
- STATUS 4-12, 4-80
- computer mode 4-1, 4-3, 4-11
- configuration information 2-1
- connector
  - RS-232 Printer/Controller Interface 3-1
  - TO DCE 1-12, 1-13
  - TO DTE 1-13
- contention 2-107, 2-108, 4-11, 4-22, B-17
- CRLF 4-11
- CTS 1-11, 1-12, 2-34, 3-2, 4-2
- cursor movement 2-56
- customer service 1-1

## D

- DATA bits 4-1, 4-2
- DATA INTERFACE MODULES 5-10
- DATA INV 2-40
- data inversion 2-88
- data loss 2-89, 2-91
- DCD 4-2
- DCE 1-10, 2-46, 2-98, 2-100, 2-101, 3-1, 4-1
- DCE emulation 2-104
- DCE Operation 1-11
- DE Bit F-18
- Degraded minutes C-4
- delay 2-105, 2-106
- DELAY START 2-100
- DELAY STOP 2-100
- delayed 4-11
- Delta print 2-64
- DEMOD JITTER OUT 2-100
- Dimensions 2-9
- DIP switch 4-6
- display window 2-1
- DLCI Field F-18
- DS1 Jitter Generation B-7
- DS1 Jitter Spectral Analysis B-4
- DS1 Spectral Analysis B-5
- DS1 Wideband Jitter B-1, B-2
- DSR 1-11, 1-13, 1-14, 2-42, 3-2, 4-2
- DTE 1-10, 2-47, 2-100, 2-101
- DTE emulation 2-104
- DTE Operation 1-10
- DTR 1-11, 1-13, 1-14, 2-44, 3-2
- dumb terminal 3-1

# INDEX (Continued)

## E

- EA Bit F-18
- emulate 2-101
- EMULATE DCE 2-101
- EMULATE DTE 2-101
- emulating 2-34, 2-42, 2-43, 2-44, 2-94, 2-96
- emulation 2-83, 2-104
- Enable Register 4-90, 4-91
- Environmental Specifications 2-8
- EOI 4-11
- EPROM card 1-1
- ERROR 2-100
- error analysis 2-101
- Error Available 4-92
- Error Buffer 4-92
- error message 1-6, 4-99
- Errors:
  - Command 4-100
  - Execution 4-100
  - Query 4-102
- ESC 4-4
- Event Status Enable Register 4-94
- Event Status Register 4-94
- execution 4-11
- external modulation B-8

## F

- Factory Retrofit Option F-2
- fan 2-98, A-1
- FCS Field F-18
- FECN Bit F-18
- FIREBERD 6000R 5-1, 5-6
- FIREBERD MC6000 5-1
- Flush Door Accessory 5-6
- Frame Abort Pattern F-18
- Frame Relay Frame F-17
  - BE CN Bit F-18
  - C/R Bit F-18
  - DE Bit F-18
  - DLCI field F-18
  - EA Bit F-18
  - FCS field F-18
  - FECN Bit F-18
  - Frame Length F-8
  - Frame Load F-6
  - Frame Transmit F-4
- HEADER F-4
- Link Management F-8
- Link Mgmt Type F-9
- Results On DLCI F-3

- TX DLCI F-5
- Frame Relay menu F-2
  - Full Status Poll F-9
  - PING menu F-7
  - Status Poll F-9
- Frame Relay Option F-1
- Frame Relay Results F-10
  - delta print F-12
  - ERROR category F-10
  - error print F-12
  - histogram results F-13
  - PERFORMANCE category F-11
  - results prints F-12
- Frame Relay Status Indicators F-10
- Frame Relay Technology F-17
- Frame Relay Testing F-19
- frequency deviation stress testing 2-105
- frequency measurements 2-104
- FUNCTIONAL DESCRIPTION 2-1
- fuse 1-3, 1-5, 2-98

## G

- G.703 Jitter Generation and Wideband Measurement B-10, B-14
- G.703 Jitter Spectral Analysis B-10, B-19
- G.821 Performance C-1
- GEN CLK 2-98
- GEN CLK IN 2-94, 2-100
- GEN CLK OUT 2-100
- GEN DATA 2-98
- GEN PATT SYNC 2-98
- ground jumper 1-3, 1-4
- GTL 4-67

## H

- hexadecimal digits 2-57
- histogram analysis 3-11
- histogram samples 3-13

## I

- IEEE-488 address 3-1
- IEEE-488 Interface 2-98
- IEEE-488 Printer/Controller Interface 3-1, 4-5
- In-warranty equipment A-2
- indicators 2-9
- Information Field F-18
- input buffer 4-11
- instantaneous jitter B-12



# INDEX (Continued)

interface 1-1, 1-10

30447A 5-3

30481 5-3

30524 5-2

30608 5-2

30609 5-2

30678 5-3

40182 5-4

40200 5-3

40202 5-3

40204 5-4

40226 5-4

40298 5-4

40540 5-3

41075 5-4

41131 5-3

41400 5-3

41440 5-3

41800 5-2

41910 5-4

41945 5-3

42219 5-4

42242 5-4

42522 5-4

CCITT 1-1

Data 1-1

DDS 1-1

installing 1-14, 5-4

RS232 1-10, 1-12, 1-13

Specialty 1-1

T-Carrier 1-1

Interface Extender 5-6

Interface History Enable Register 4-99

Interface History Enable Status Register 4-83

Interface History Register 4-98

Interface History Status Register 4-82

Interface Loss Enable Register 4-99

Interface Loss Enable Status Register 4-84

Interface Loss Register 4-99

Interface Loss Status Register 4-84

interface modules 5-2

interface slot 1-1, 2-100

Interface Status Register 4-81, 4-97

INTERFACE SWITCHING UNITS 5-9

interfaces 1-5

internal modulation B-8

Internal RS232 Synchronous 1-12

ISU 1-15, 1-16, 5-5, 5-9

## J

Jitter B-10

softkey

AMPL B-9

DOWN B-5

FILTER B-2

FREQ B-9, B-17

GEN B-17

GRAPH B-2, B-20

HITS B-12

Hz B-9

LIST B-2, B-20

MASK B-10

MOD B-8, B-17

OFF B-5

ON B-5

PEAK B-20

RANGE B-12

S/A B-19

SWEEP B-5, B-9, B-20

UI p-p B-17

UP B-5

jitter amplitude B-8, B-15

jitter generation B-19

jitter hit B-2, B-12

jitter hit threshold B-12

jitter masks B-10

JITTER MOD IN 2-100

jitter results B-12

jitter sweep B-8

menus

JITTER 2-63

## K

keypad 2-56

## L

LEDs 1-6, 2-1

(RL) 2-81

(TM) 2-96

ALM1 2-12

ALM2 2-12

CLK INV 2-104

CODE 2-33

DSR (DM) 2-42

DTR 2-44

FRM SYNC 2-49

## INDEX (Continued)

LL) 2-51  
MK 2-1, 2-76  
NO CLK 2-104  
RLSD (RR) 2-82  
RTS 2-84  
SP 2-1, 2-87  
SYNC 2-1, 2-88  
LF 4-11  
Line History Enable Register 4-96  
Line History Enable Status Register 4-87  
Line History Register 4-96  
Line History Status Register 4-86  
Line Loss Enable Register 4-97  
Line Loss Enable Status Register 4-88  
Line Loss Register 4-96  
Line Loss Status Register 4-87  
Line Status Register 4-85, 4-94  
Line Summary Register 4-94  
line terminators 4-3  
Link Layer Analysis F-13  
LL 2-51  
LLO 4-68  
LMI F-14  
LMI Analysis and Emulation F-14  
Load Generation and Analysis F-13  
LOCAL 4-3  
local lockout 4-1  
Long User Pattern 2-88

### M

maintenance A-1  
maximum amplitude B-20  
maximum jitter B-19  
menus  
  AUXILIARY 2-67  
  CHAR FORMAT 2-62  
  INTF SETUP 2-60  
  PRINT EVENT 2-55, 2-64  
  STORE/RECALL/NAME 2-66  
  SYNTH FREQ 2-59  
  TEST INTERVAL 2-61  
message  
  232 REMOTE CONTROL 4-3  
  232 REMOTE CONTROL <ENTER> TO  
    ABORT 4-1  
  488 REMOTE CONTROL 4-6  
  Async Frequency Contention 1-13  
  ASYNC PATTERN CONTENTION 1-14  
  Async Pattern Contention 1-13  
  AUTO BAUD IN PROGRESS 4-4

Auto-baud achieved. Press <ESCAPE> to continue. 4-4  
AUTOBAUD IN PROGRESS 4-4  
Character format determined. 4-4  
EMPTY 2-60  
Enter frequency in kHz  
  .05-15000 2-59  
Enter time interval, 24 hr max, HH  
  MM 2-61  
Interface and jitter not compatible 2-63  
NO SAMPLES READY 3-14  
OPERATION COMPLETE 4-10  
Option not installed 2-63  
Pre sync/power loss results not available 2-74,  
  2-90  
SYNTH DEFAULTS TO 2048 (64) kHz WITH JIT  
  GEN B-15  
Synth defaults to xxx kHz with jit gen 2-59  
Test Complete 2-61  
Transmitting Loop Code 2-52, 2-53  
modulation frequency B-8, B-15  
MORE key 2-56

### N

NO CLK 2-77  
Non-Status-Select Auxiliary Functions 2-71, 2-72,  
  2-73  
NOVRAM 1-6  
NPID F-14

### O

options 5-2  
out-of-band flow control 2-34, 2-43, 2-45, 2-83  
out-of-service testing 2-35  
out-of-warranty equipment A-2  
Output Queue 4-11, 4-91

### P

Parallel Poll Enable Register 4-33  
PARITY 4-2  
parity 4-1  
pattern 2-88, 2-106, 4-22  
pattern slips 2-104  
PEAK B-5  
peak jitter threshold B-2  
phase displacement B-10  
phase relationship 2-104  
power 1-2  
power cord 1-5  
Power Requirements 2-8

## INDEX (Continued)

PR-2000 5-5, 5-6, 5-7  
PR-40A 3-1, 5-5  
PR-85 Printer B-20  
PR-85 Soft Carrying Case 5-9  
PR2000 5-6  
precautions 1-4  
Print Available 4-91  
Print Queue 4-91  
printer interface 3-1  
PRINTERS 5-10  
printout 1-1, 2-2, 3-1, 3-2, 3-5  
prints  
    automatic 3-3  
    controls 3-2, 3-3  
    custom results 3-6  
    Delta 3-9, 3-15  
    histogram 3-2  
        automatic 3-13  
        Graph 3-13, 3-15  
        List 3-13, 3-15  
        manual 3-13, 3-14  
    jitter frequency 3-2  
    long results 3-6  
    manual 3-3  
    results 3-2, 3-4  
    standard results 3-6  
    status 3-10  
program message 4-11  
prompt 4-1, 4-2  
Protocol Statistics F-1  
Pseudoternary signals 2-95  
purchase order number A-2  
PVC's F-5

### Q

QUERIES 4-10  
query 4-11

### R

RA A-2  
Rack Mount Adaptor 5-6  
RACK MOUNTS 5-9  
RC Print Queue 4-91  
RCVR CLK 2-98  
RCVR DATA 2-98  
RCVR PATT SYNC 2-100  
RD 3-2, 4-2  
rear panel 2-98  
Recovered operation 2-94  
recovered timing 2-89, 2-94

Reference Model F-17  
Registers 4-90  
remote control 4-1  
Remote control commands 4-12, F-15  
remote control mode 4-3  
response 4-10, 4-11  
response message 4-11  
result print 3-2  
results 1-1  
    ALARM 2-30  
    ERROR 2-19  
    PERFORMANCE 2-21  
    SIGNAL 2-24  
    T-CARRIER 2-26  
    TIME 2-23  
resynchronize 2-90  
Return Authorization A-2  
Return Instructions A-2  
Ri 1-12  
RL 2-81  
RLSD 1-11, 1-13, 1-14, 3-2  
Round-trip delay 2-106  
RR 2-82  
RS-232 auxiliary function 3-11  
RS-232 print format auxiliary function 3-11  
RS-232 Printer/Controller Interface 2-98, 4-1, 5-5  
RS-232-C Connector Pin Assignments 1-11  
RS232 Interface 1-7  
RS232 Printer/Controller Interface 3-1, 5-5  
RTS 1-11, 1-13, 1-14

### S

samples 3-14  
Selecting The Frame Relay Option F-2  
Self Test Byte value 4-37  
self-loop mode 2-86  
self-test 1-6, 1-7  
    Data Generator 1-9  
    Error Counter and Error Insert 1-8  
    Frequency Synthesizer and Frequency Counter 1-7  
    Seconds and Blocks 1-9  
    Time and Date 1-10  
self-test  
    Synchronous Transmit and Receive 1-8  
semicolon 4-11  
service A-1  
Service Request Enable Register 4-35  
SIG GND 2-100  
signaling leads 2-34, 2-83  
SNAP F-14

# INDEX (Continued)

- Soft Carrying Case 5-8
- softkey
  - jitter
    - AMPL B-17
- software revision 1-6
- Spectral Analysis option B-5
- spectral analysis results B-19
  - status prints
    - histogram 3-2
- ST 2-94, 2-104
- Standard Event Status Enable Register 4-30
- Standard Event Status Register 4-30
- Status Byte Enable Register 4-92, 4-93
- Status Byte Register 4-36, 4-91, 4-92
- status events 3-10
- Status register 4-90
- status-select auxiliary functions 2-68
- summary bit 4-90
- sweep function B-19
- sweeping B-20
- switches 1-5, 2-9
  - ANALYSIS MODE 1-6, 2-1, 2-13, 2-61
  - ANALYSIS RESULTS 2-14
  - CONTROLS 2-1, 3-3
  - DATA 1-5, 1-12, 1-13, 2-35
  - DISPLAY HOLD 2-1, 2-41, 2-79, 2-89
  - DSR (DM) 2-43
  - DTR 2-45
  - ENTER 2-58, 2-59, 2-66
  - ERROR INSERT 2-48
  - GEN CLK 1-5, 1-12, 2-50, 2-94, 2-95, 2-104
  - LOOP DOWN 2-52
  - LOOP UP 2-53
  - MENU 1-6, 1-10, 1-15, 2-1, 2-54, 2-55
    - CHAR FORMAT 1-13
    - INTF SETUP 1-12, 1-16
    - SYNTH FREQ 1-12, 1-13
  - ON/OFF 3-3
  - POWER 2-78
  - PRINTER ON/OFF 2-1
  - push button 1-5
  - RESTART 1-6, 2-1, 2-80
  - RESULTS 2-1, 3-4
  - RESULTS PRINT 2-79
  - RLSD (RR) 2-83
  - rocker 1-5
  - RTS 2-85
  - SELF LOOP 2-86
  - SHIFT 2-57
  - SYNC LOST 2-91
  - TIMING MODE 1-5, 2-59, 2-93, 2-95
  - VOLUME 2-97
  - SYNC 2-100
  - synchronization 2-89
  - Synchronization Loss 2-89
  - Synchronous operation 2-93
  - synchronous timing 2-89, 2-94
  - synthesizer frequency 2-59, 2-94
- T**
- TALK-ONLY mode 3-1, 4-5
- TC 1-10
- TD 1-10, 3-2, 4-2
- terminal mode 4-1, 4-2, 4-3
- terminator 4-11
- test
  - in-service 1-6
  - out-of-service 1-5
- TEST INTERVAL 2-13, 2-61, 2-65
- test points 2-98
- timing 2-102
- Timing analysis 2-103
- timing measurement 2-104
- timing selections 2-93
- TM 2-96
- TO DCE 2-101
- TO DTE 2-101
- TT 2-94, 2-104
- U**
- UDF F-14
- unavailable time C-2, C-3, C-4
- unit address 4-6
- Up-Arrow (Δ) key 2-56
- V**
- VAC 2-98
- vacuum florescent display 2-1
- vertical scale 3-13
- voltage selector 1-2, 2-98
- W**
- warnings 1-4
- warranty A-1
- Weight 2-9
- wideband measurement B-19
- X**
- XTC 1-10